

בקשה לרישום סימן מסחר 374698

על שם מגלולה בע"מ

קובץ הראיות / נספחים לתצהיר מר גיא טל מטעם המבקשת

לצורך ביסוס אופי מבחין נרכש

אני הח"מ גיא טל ת.ז. 057544280 בשם מגלולה בע"מ מספר ח.פ. 513373746 לאחר שהוזהרתי כי עלי לאמר את האמת וכי אהיה צפוי לעונשים הקבועים בחוק אם לא אעשה זאת, מצהיר בכתב כל הנספחים המצויים בקובץ זה, מהווים חלק בלתי נפרד מתצהירי, שהוגש כמענה לדוח הבחינה בתיק זה.

אני הח"מ נח שלומוביץ, עו"ד, מאשר בזה כי ביום _____, התייצב מר גיא טל, המוכר לי אישית, אישר את נכונות הצהרתו דלעיל וחתם עליה בפני.

מס'	פריט	סוג	תיאור	מקור/פרסום/תאריך/הערות	עמוד
1	סכום מכירות ללקוח	מסמך הנה"ח	הסכום הכולל של כלל המכירות ל למפיצה הראשית של המוצר בישראל (להב בע"מ), לחמש וחצי שנים.	1/1/2020 עד 6/5/2025 מלמד על כלל המכירות באותה תקופה למפיצה על סך 431215 ₪.	1
2	פירוט מכירות ללקוח	מסמך הנה"ח	פירוט המכירות של המוצר נשוא הבקשה למפיצה הראשית באותה התקופה	1/1/2020 עד 6/5/2025 מלמד על כך שמתוך כלל המכירות הרוב המכריע כ 370,000 ₪, הם של המוצר נושא סימן המסחר המבוקש לרישום .	2-5
3	מודעות פרסום	פרסום מטעם המבקשת	חומר פרסומי/קטלוגי של Maglula המהווה דוגמאות advertising.	מודעות פרסום מטעם המבקשת בשימוש לאורך השנים, כולל מבצעים מיוחדים, או הוצאות מיוחדות (כגון 20 שנות מכירה בארה"ב בצבעי הדגל האמריקאי ועוד)	6-35
4	מודעת פרסום	פרסום מטעם המבקשת	דוגמא למודעות פרסום ממומן ,Airforce Times , Army-Times ,Times, MarineCorps Navy Times	פרסום בתשלום מטעם המבקשת במגזינים של טיימס לכוחות הבטחון: מוצגים לדגמא פרסומים בגיליונות אוגוסט, ספטמבר, אוקטובר, נובמבר ודצמבר שנת 2001 של כל ארבעת המגזינים.	36-75
5	מודעות פרסום במגזינים של טיימס	פרסום מטעם המבקשת	דוגמא למודעות פרסום בתשלום מטעם המבקשת במגזינים מקצועיים	פרסום במהלך השנים 2016-2023 <i>GUNS, American Handgunner, Shooting Industry Magazine, Shooting Sports Retailer, Stars and Stripes Military Times, Air Force Times, Army Times, Marine Corps. Times, Navy Times, and NRA publications</i> Between the years 2013-2023	97-101
6	/ AllOutdoor Maglula Loaders Skip the Busted Thumbs	כתבת/סקירת מדיה לא מוזמנת	סקירה צרכנית/מאמר לא מוזמן על ה-UpLULA.	;AllOutdoor; Maglula Loaders Skip the Busted Thumbs ;Dr. John Woods; 2015-02-19 -https://www.alloutdoor.com/2015/02/19/maglula-loaders/skip-busted-thumbs	102-105
7	/ American Rifleman Preview: Maglula US-Flag Uplula Loader	כתבת/סקירת מדיה לא מוזמנת	פריט חדשות/תצוגה מקדימה על גרסת US-Flag של ה-UpLULA.	American Rifleman; Preview: Maglula US-Flag Uplula ;Loader; American Rifleman Staff; 2022-04-20 -https://www.americanrifleman.org/content/preview/maglula-us-flag-uplula-loader	106-109
8	/ AmmoLand - Magazine Loader & Video Demo Review of Magloader, MAG Pump & Caldwell	כתבת/סקירת מדיה לא מוזמנת	סקירה והשוואה בין טועני מחסניות, עם התייחסות חיובית ל-UpLULA.	AmmoLand; Magazine Loader - Video Demo & Review of ;Magloader, MAG Pump & Caldwell; Brian)Rev(Norris -https://www.ammoland.com/2017/06/gun ;29-06-2017/magazine-loader	110-117
9	COncealedCarry	כתבת/סקירת מדיה לא מוזמנת	סקירה על המבקשת ומקימיה, ועל המוצר	.Maglula Uplula – Coolest product wierdest name	118-122
10	GunMagWarehouse Maglula UpLULA / Mag Loader: Save Your Thumbs	כתבת/סקירת מדיה לא מוזמנת	כתבת מוצר/בלוג מסחרי על ה-UpLULA.	GunMagWarehouse; Maglula UpLULA Mag Loader: Save ;Your Thumbs; William Lawson; 2023-02-15 -https://gunmagwarehouse.com/blog/maglula-uplula-mag/loader-save-your-thumbs	123-129
11	/ Guns & Ammo Maglula To The Rescue - Loading Your Magazine Quickly	כתבת/סקירת מדיה לא מוזמנת	סקירת מוצר באתר Ammo &	Guns & Ammo; Maglula To The Rescue - Loading Your ;Magazine Quickly -https://www.gunsandammo.com/editorial/maglula-to-the-rescue-loading-your-magazine-quickly/248043	130-140
12	/ Guns Magazine UpLULA Magazine Loader - Ease the Pain and Shoot !More	כתבת/סקירת מדיה לא מוזמנת	סקירה צרכנית/כתבת ציוד על ה-UpLULA.	Guns Magazine; UpLULA Magazine Loader - Ease the ;Pain and Shoot More!; David Freeman; 2019 /https://gunsmagazine.com/gear/uplula-magazine-loader	141-146

מס'	פריט	סוג	תיאור	מקור/פרסום/תאריך/הערות	עמוד
13	Gun University / 5 Best 9mm Magazine Speed Loaders [2023]	כתבת/סקירת מדיה לא מוזמנת	כתבת דירוג/השוואה שבה ה-UpLULA נכלל בין טועני המחסניות הבולטים.	Gun University; 5 Best 9mm Magazine Speed Loaders ;Dave Chesson; 2023-05-29 ;[2023] -https://gununiversity.com/best-9mm-magazine-speed/loaders	147-162
14	/ Hunting Gear Guy Maglula Uplula Mini Review	כתבת/סקירת מדיה לא מוזמנת	סקירת מוצר/mini .review	;Hunting Gear Guy; Maglula Uplula Mini Review -https://www.huntinggareguy.com/equipment/reviews/maglula-uplula-mini-review	163-166
15	NRA Women / We Love It: Maglula UpLULA	כתבת/סקירת מדיה לא מוזמנת	כתבת המלצה/ציוד באתר NRA Women.	NRA Women; We Love It: Maglula UpLULA; NRA ;Women Staff; 2020-04-28 -https://www.nrawomen.com/content/we-love-it-maglula/uplula	167-171
16	OpticsPlanet Reviews / דף ביקורות על Maglula UpLULA	כתבת/סקירת מדיה לא מוזמנת	צילומי מסך של דף ביקורות/חוות דעת צרכנים.	Maglula על דף ביקורות לקוחות על Maglula UpLULA; https://www.opticsplanet.com/reviews/reviews/maglula-uplula-universal-pistol-magazine-loader.html	172-175
17	/ Pew Pew Tactical Best Pistol Magazine Speed Loaders [Hands-On Tested]	כתבת/סקירת מדיה לא מוזמנת	כתבת השוואה hands-on של speed loaders עם אזכור/מיקום של ה-UpLULA.	Pew Pew Tactical; Best Pistol Magazine Speed Loaders ;[Hands-On Tested] -https://www.pewpewtactical.com/best-magazine-speed/loaders	176-187
18	Firearmsguide/TEST	כתבת מבחן	כתבת מבחן/סקירה למוצר ולמוצר נוסף של המבקשת	Firearmsguide/TEST: The LULA UpLULA Magazine 2023 speedloaders אוגוסט 2023	188-192
19	Shooting sports retailer	סקירת מוצר למוצר	סקירת מוצר למוצר	Shooting sports retailer	193-194
20	/ Shooting Industry Familiar Favorites Continue to Resonate	כתבת/סקירת מדיה לא מוזמנת	כתבה מקצועית בענף כלי הירי; מזכירה את Maglula/UpLULA בהקשר שיווקי וקמעונאי.	Shooting Industry; Familiar Favorites Continue to Resonate; Melissa Porter; 2020 -https://shootingindustry.com/discover/arms-and-the/woman/familiar-favorites-continue-to-resonate	195-200
21	Sniper Country	כתבת/סקירת מדיה לא מוזמנת	סקירה השוואתית של המוצר אל מול מוצרי פרימיום נוספים.	Sniper count: The four best Glock speed loaders	201-210
22	SOFREP / UpLULA Pistol Mag Loader Quick Look	כתבת/סקירת מדיה לא מוזמנת	סקירה קצרה/Quick Look.	SOFREP; UpLULA Pistol Mag Loader Quick Look; Erik -Meisner; 2017-06-12; https://sofrep.com/gear/uplula/pistol-mag-loader-quick-look	211-218
23	SpiceTac / Maglula Speed Loader Review	כתבת/סקירת מדיה לא מוזמנת	סקירת מוצר מסחרית/בלוג.	;SpiceTac; Maglula Speed Loader Review /https://www.spicetac.com/maglula-speed-loader-review	219-223
24	The Truth About Guns / The One and Only Pistol Magazine Loader I Recommend	כתבת/סקירת מדיה לא מוזמנת	כתבת דעה/סקירה על ה-UpLULA.	The Truth About Guns; The One and Only Pistol Magazine Loader I Recommend; Dan Zimmerman; 2018 -https://www.thetruthaboutguns.com/the-one-and-only-pistol-magazine-loader-i-recommend	224-232
25	The Warrior Solution / The Best Pistol Speed Loader - On The Market Maglula UpLULA Hands-on Review (Video)	כתבת/סקירת מדיה לא מוזמנת	סקירת hands-on/וידאו.	The Warrior Solution; The Best Pistol Speed Loader On The Market - Maglula UpLULA Hands-on Review -Video(; https://thewarriorsolution.com/the-best-pistol-speed-loader-on-the-market-maglula-uplula-universal-pistol-loader-and-unloader-review	233-238
26	/ The Armory Life Review/How to Use the UpLula (וידאו/עמוד משלים)	כתבת/סקירת מדיה לא מוזמנת	עמוד תוכן/וידאו עם הפניה ל-Maglula UpLULA;	The Armory Life; Review/How to Use the UpLula -GunSpot / The Armory Life; 2020-02 (וידאו/עמוד משלים); מופיע בדף; 17-05-2021 / 03-03-2021 / 26 /https://thearmorylife.com	239-245

מס'	פריט	סוג	תיאור	מקור/פרסום/תאריך/הערות	עמוד
27	/ Field & Stream Media Kit / audience pages used as circulation proof	כתבת/סקירת מדיה לא מוזמנת	דפי audience/media-kit של Field & Stream ששימשו כראיית חשיפה.	Field & Stream; Media Kit / audience pages used as circulation proof; 2023-09-22 capture -https://recurrent.io/wp-content/uploads/2023/07/2023-Field-Stream-Media-Kit.pdf	246-254
28	The Small Arms Review	מדיה לא מוזמנת	עמוד/צילום מסך מתוך סקירת מוצר לא מוזמנת	The Small Arms Review מהדורת נובמבר 2008	255
29	Shooting Industry article	מדיה לא מוזמנת	כתבת Shooting Industry 'Familiar Favorites Continue to Resonate' עם אזכור Maglula/UpLULA	;Shooting Industry; Melissa Porter; 2020 -https://shootingindustry.com/discover/arms-and-the-woman/familiar-favorites-continue-to-resonate	256-261
30	Guns Magazine article	מדיה לא מוזמנת	כתבת Guns Magazine 'UPLULA' MAGAZINE LOADER - Ease the Pain and Shoot More	;Guns Magazine; David Freeman; 2019 /https://gunsmagazine.com/gear/uplula-magazine-loader	262-263
31	American Rifleman	מדיה לא מוזמנת / חדשות	ידיעה/כתבה ב-American Rifleman/NRA על המאבק של Maglula נגד Amazon.	The Keefe Report; NRA / American Rifleman	264
32	American Rifleman preview	מדיה לא מוזמנת	עמוד תצוגה/preview של American Rifleman Maglula US-Flag UpLULA	American Rifleman; Preview: Maglula US-Flag Uplula Loader; 2022-04-20	265
33	תמונות לקוחות	עדות צרכנים / screenshot	דוגמאות של חלק מקבצי תמונות של לקוחות המצויים בידי המבקשת.	צילומים של לקוחות שנשלחו למבקשת, בהם נראה כל הלקוח, עם המוצר עצמו, ומצוין מספר הכדורים שהוטענו באמצעות Maglula.	266-291
34	צילומים מתערוכות	צילום / תיעוד תערוכה / display	תמונות מתוך תיעוד של מגוון תצוגות/תערוכות של Maglula, בהן הוצג ונחשף המוצר.	סדרות צילומים ממגוון תערוכות שונות שהתקיימו במהלך השנים בין השאר: Las Vegas trade show SHOT Show National Association of Sporting Goods 20172016+ Wholesalers booth	292-334
35	כתבה על SHOT 2019 Show attendance	כתבת מדיה / attendance proof	כתבת Las Vegas Review-Journal 'More than 58K attending SHOT Show in Las Vegas' מציינת את מספר מבקרים בתערוכה.	;Las Vegas Review-Journal; Todd Prince; 2019-01-20 -https://www.reviewjournal.com/business/conventions/shot-show/more-than-58k-attending-shot-show-in-las-vegas/1577754	335-342
36	צילומים מתערוכה.	צילום / תיעוד תערוכה / display	תמונות מתוארכות ינואר 2019; של דוכן 2019 SHOT Show, המוזכר בכתבה הקודמת	SHOT Show booth 2019	343-347
37	Screenshot 1 - New shooting sports gear LIVE from NASGW	צילום מסך רשת חברתית / וידאו	צילומי מסך של פוסט/וידאו עם הכותרת 'New shooting sports gear LIVE from NASGW'. המסקרים את המוצר	Facebook / Gunstuff video capture; 2023-09-03 capture ה-NASGW (האיגוד הלאומי של סיטונאי מוצרי ספורט) הוא הגוף המרכזי המארגן את אחד האירועים העסקיים החשובים ביותר בתעשיית הירי בארה"ב.	348-349
38	מוצרים מזויפים / counterfeit products	זיופים / copying	עמוד דוגמאות של loaders מזויפים/מעתיקים, לעיתים באריזה שקופה דומה.	Counterfeit examples	350
39	- Amazon listing Solid Desigins Magazine Loader	עיצובים הלופיים / competitor designs	צילום מסך של loader הלופי/מתחרה, המשמש להראות ריבוי עיצובים פונקציונליים הלופיים בשוק.	Marketplace / product page screenshot ניתן לראו בבירור, שהמתחרים הלגיטימיים בשוק, מעצבים באופן שונה לחלוטין את המוצרים שלהם, ורק זייפנים, משתמשים בהעתקים שנועדו לשוות למוצר מראה של מוצר מקומי.	351-358

מס'	פריט	סוג	תיאור	מקור/פרסום/תאריך/הערות	עמוד
40	:YouTube review UpLula Pistol Mag Loader & Unloader / 9mm to 45ACP Magazine Speed Loader Review	YouTube / review screenshot	צילום מסך של סרטון YouTube עם כותרת מפורטת על סקירת ה- .UpLULA	אחד מעשרות הסרטונים המציגים את המוצר, שלא נערכו בידי המבקשת YouTube; URL visible in screenshot; capture 2023-09-10	359
41	:YouTube review Maglula Magazine Loader Simply !Amazing	YouTube / review screenshot	צילום מסך של הסרטון 'Maglula Magazine' Loader Simply "!Amazing	אחד מעשרות הסרטונים המציגים את המוצר, שלא נערכו בידי המבקשת YouTube; hickok45	360
42	:YouTube review UpLULA Universal Pistol Magazine Loader	YouTube / review screenshot	צילום מסך של הסרטון 'UpLULA Universal' Pistol Magazine 'Loader	אחד מעשרות הסרטונים המציגים את המוצר, שלא נערכו בידי המבקשת YouTube; BigDaddyHoffman1911	361-363

MAGLULA LTD

מגלולה בע"מ, גיא טל

06/05/25 14:44

מתאריך 01/01/20, עד תאריך 06/05/25, מס. לקוח '100050' =

מכירות ללקוחות (חשבוניות)

נכון לתקופה: 06/05/2025-01/01/2020

מטבע	הכנסה משוערכת	מטבע	הכנסה	הכנסה כולל מע"מ	שם לקוח	מס. לקוח
ש"ח	431,214.34	ש"ח	431,214.34	505,150.00	להב בע"מ	100050
ש"ח	431,214.34					סה"כ כללי

חופף באמצעות Priority © - פירוטי, יוטיס ווסטור ג"מ

מתאריך אספקה 01/01/20, עד תאריך אספקה 06/05/25, הזמנות פתוחות בלבד? N, מס. לקוח '100050', הזמנה **, מק"ט *UP60, סוג הזמנה '000' =

הזמנות לפי לקוח

נכון לתקופה: 06/05/2025-01/01/2020

הזמנה	ת. אספקה	מק"ט	תאור מוצר	כמות	יתרה לאספקה	יח'	מחיר כולל	שווי יתרה	מטבע	מחיר כולל בשקלים	סוג הזמנה	תאור סוג הזמנה
מס. לקוח: 100050, שם לקוח: להב בע"מ												
SO21000122	19/04/21	UP60B	UpLULA universal loader 9 - .45 - Black	180.00		יח'	8,640.00	0.00	ש"ח	8,640.00	000	כללית - ריק
SO21000122	19/04/21	UP60DG	UpLULA universal loader 9 - .45 - Dark Green	36.00		יח'	1,728.00	0.00	ש"ח	1,728.00	000	כללית - ריק
SO21000122	19/04/21	UP60BO	UpLULA universal loader 9 - .45 - Orange Brown	18.00		יח'	864.00	0.00	ש"ח	864.00	000	כללית - ריק
SO21000122	19/04/21	UP60L	UpLULA universal loader 9 - .45 - Lemon	72.00		יח'	3,456.00	0.00	ש"ח	3,456.00	000	כללית - ריק
SO21000122	19/04/21	UP60P	UpLULA universal loader 9 - .45 - Pink	12.00		יח'	576.00	0.00	ש"ח	576.00	000	כללית - ריק
SO21000122	19/04/21	UP60PR	UpLULA universal loader 9 - .45 - Purple	30.00		יח'	1,440.00	0.00	ש"ח	1,440.00	000	כללית - ריק
SO21000160	31/05/21	UP60B	UpLULA universal loader 9 - .45 - Black	150.00		יח'	7,200.00	0.00	ש"ח	7,200.00	000	כללית - ריק
SO21000160	31/05/21	UP60P	UpLULA universal loader 9 - .45 - Pink	30.00		יח'	1,440.00	0.00	ש"ח	1,440.00	000	כללית - ריק
SO21000160	31/05/21	UP60PR	UpLULA universal loader 9 - .45 - Purple	30.00		יח'	1,440.00	0.00	ש"ח	1,440.00	000	כללית - ריק
SO21000178	27/06/21	UP60US	UpLULA universal loader 9 - .45 - US Flag	30.00		יח'	1,440.00	0.00	ש"ח	1,440.00	000	כללית - ריק
SO21000297	10/11/21	UP60DG	UpLULA universal loader 9 - .45 - Dark Green	60.00		יח'	2,880.00	0.00	ש"ח	2,880.00	000	כללית - ריק
SO21000297	10/11/21	UP60L	UpLULA universal loader 9 - .45 - Lemon	30.00		יח'	1,440.00	0.00	ש"ח	1,440.00	000	כללית - ריק
SO21000297	10/11/21	UP60PR	UpLULA universal loader 9 - .45 - Purple	30.00		יח'	1,440.00	0.00	ש"ח	1,440.00	000	כללית - ריק
SO21000297	10/11/21	UP60B	UpLULA universal loader 9 - .45 - Black	60.00		יח'	2,880.00	0.00	ש"ח	2,880.00	000	כללית - ריק
SO21000297	10/11/21	UP60BO	UpLULA universal loader 9 - .45 - Orange Brown	60.00		יח'	2,880.00	0.00	ש"ח	2,880.00	000	כללית - ריק
SO22000101	25/04/22	UP60B	UpLULA universal loader 9 - .45 - Black	96.00		יח'	4,608.00	0.00	ש"ח	4,608.00	000	כללית - ריק
SO22000161	25/07/22	UP60P	UpLULA universal loader 9 - .45 - Pink	24.00	-6.00	יח'	1,152.00	-288.00	ש"ח	1,152.00	000	כללית - ריק
SO22000161	25/07/22	UP60PR	UpLULA universal loader 9 - .45 - Purple	18.00		יח'	864.00	0.00	ש"ח	864.00	000	כללית - ריק
SO22000161	25/07/22	UP60B	UpLULA universal loader 9 - .45 - Black	90.00		יח'	4,320.00	0.00	ש"ח	4,320.00	000	כללית - ריק
SO22000161	25/07/22	UP60L	UpLULA universal loader 9 - .45 - Lemon	18.00		יח'	864.00	0.00	ש"ח	864.00	000	כללית - ריק
SO22000161	25/07/22	UP60BO	UpLULA universal loader 9 - .45 - Orange Brown	18.00		יח'	864.00	0.00	ש"ח	864.00	000	כללית - ריק
SO22000229	09/11/22	UP60US	UpLULA universal loader 9 - .45 - US Flag	24.00		יח'	1,152.00	0.00	ש"ח	1,152.00	000	כללית - ריק
SO22000229	09/11/22	UP60B	UpLULA universal loader 9 - .45 - Black	48.00		יח'	2,304.00	0.00	ש"ח	2,304.00	000	כללית - ריק
SO22000229	09/11/22	UP60DG	UpLULA universal loader 9 - .45 - Dark Green	18.00		יח'	864.00	0.00	ש"ח	864.00	000	כללית - ריק
SO22000229	09/11/22	UP60BO	UpLULA universal loader 9 - .45 - Orange Brown	6.00		יח'	288.00	0.00	ש"ח	288.00	000	כללית - ריק
SO22000229	09/11/22	UP60L	UpLULA universal loader 9 - .45 - Lemon	12.00		יח'	576.00	0.00	ש"ח	576.00	000	כללית - ריק
SO22000229	09/11/22	UP60PR	UpLULA universal loader 9 - .45 - Purple	6.00		יח'	288.00	0.00	ש"ח	288.00	000	כללית - ריק
SO22000263	25/12/22	UP60B	UpLULA universal loader 9 - .45 - Black	96.00	6.00	יח'	4,608.00	288.00	ש"ח	4,608.00	000	כללית - ריק
SO22000263	25/12/22	UP60DG	UpLULA universal loader 9 - .45 - Dark Green	18.00		יח'	864.00	0.00	ש"ח	864.00	000	כללית - ריק
SO22000263	25/12/22	UP60BO	UpLULA universal loader 9 - .45 - Orange Brown	6.00		יח'	288.00	0.00	ש"ח	288.00	000	כללית - ריק
SO22000263	25/12/22	UP60L	UpLULA universal loader 9 - .45 - Lemon	36.00		יח'	1,728.00	0.00	ש"ח	1,728.00	000	כללית - ריק
SO23000059	14/03/23	UP60B	UpLULA universal loader 9 - .45 - Black	102.00		יח'	4,896.00	0.00	ש"ח	4,896.00	000	כללית - ריק
SO23000059	14/03/23	UP60DG	UpLULA universal loader 9 - .45 - Dark Green	30.00		יח'	1,440.00	0.00	ש"ח	1,440.00	000	כללית - ריק

מתאריך אספקה 01/01/20, עד תאריך אספקה 06/05/25, הזמנות פתוחות בלבד? N, מס. לקוח '100050', הזמנה ***, מק"ט 'UP60', סוג הזמנה '000' =

הזמנות לפי לקוח

נכון לתקופה: 06/05/2025-01/01/2020

הזמנה	ת. אספקה	מק"ט	תאור מוצר	כמות	יתרה לאספקה	יח'	מחיר כולל	שווי יתרה	מטבע	מחיר כולל בשקלים	סוג הזמנה	תאור סוג הזמנה
SO23000059	14/03/23	UP60BO	UpLULA universal loader 9 - .45 - Orange Brown	30.00		יח'	1,440.00	0.00	ש"ח	1,440.00	000	כללית - ריק
SO23000059	14/03/23	UP60PR	UpLULA universal loader 9 - .45 - Purple	30.00		יח'	1,440.00	0.00	ש"ח	1,440.00	000	כללית - ריק
SO23000084	13/04/23	UP60B	UpLULA universal loader 9 - .45 - Black	192.00		יח'	9,216.00	0.00	ש"ח	9,216.00	000	כללית - ריק
SO23000130	12/06/23	UP60B	UpLULA universal loader 9 - .45 - Black	48.00		יח'	2,304.00	0.00	ש"ח	2,304.00	000	כללית - ריק
SO23000130	12/06/23	UP60L	UpLULA universal loader 9 - .45 - Lemon	48.00		יח'	2,304.00	0.00	ש"ח	2,304.00	000	כללית - ריק
SO23000130	12/06/23	UP60BO	UpLULA universal loader 9 - .45 - Orange Brown	36.00		יח'	1,728.00	0.00	ש"ח	1,728.00	000	כללית - ריק
SO23000130	12/06/23	UP60DG	UpLULA universal loader 9 - .45 - Dark Green	24.00		יח'	1,152.00	0.00	ש"ח	1,152.00	000	כללית - ריק
SO23000130	12/06/23	UP60P	UpLULA universal loader 9 - .45 - Pink	12.00		יח'	576.00	0.00	ש"ח	576.00	000	כללית - ריק
SO23000130	12/06/23	UP60US	UpLULA universal loader 9 - .45 - US Flag	12.00		יח'	576.00	0.00	ש"ח	576.00	000	כללית - ריק
SO23000196	07/09/23	UP60B	UpLULA universal loader 9 - .45 - Black	102.00	-18.00	יח'	4,896.00	-864.00	ש"ח	4,896.00	000	כללית - ריק
SO23000196	07/09/23	UP60DG	UpLULA universal loader 9 - .45 - Dark Green	18.00		יח'	864.00	0.00	ש"ח	864.00	000	כללית - ריק
SO23000196	07/09/23	UP60BO	UpLULA universal loader 9 - .45 - Orange Brown	18.00		יח'	864.00	0.00	ש"ח	864.00	000	כללית - ריק
SO23000196	07/09/23	UP60PR	UpLULA universal loader 9 - .45 - Purple	18.00		יח'	864.00	0.00	ש"ח	864.00	000	כללית - ריק
SO23000196	07/09/23	UP60US	UpLULA universal loader 9 - .45 - US Flag	18.00		יח'	864.00	0.00	ש"ח	864.00	000	כללית - ריק
SO23000229	22/10/23	UP60B	UpLULA universal loader 9 - .45 - Black	240.00		יח'	11,520.00	0.00	ש"ח	11,520.00	000	כללית - ריק
SO23000229	22/10/23	UP60DG	UpLULA universal loader 9 - .45 - Dark Green	60.00		יח'	2,880.00	0.00	ש"ח	2,880.00	000	כללית - ריק
SO23000229	22/10/23	UP60BO	UpLULA universal loader 9 - .45 - Orange Brown	60.00		יח'	2,880.00	0.00	ש"ח	2,880.00	000	כללית - ריק
SO23000229	22/10/23	UP60L	UpLULA universal loader 9 - .45 - Lemon	60.00		יח'	2,880.00	0.00	ש"ח	2,880.00	000	כללית - ריק
SO23000229	22/10/23	UP60P	UpLULA universal loader 9 - .45 - Pink	30.00		יח'	1,440.00	0.00	ש"ח	1,440.00	000	כללית - ריק
SO23000229	22/10/23	UP60PR	UpLULA universal loader 9 - .45 - Purple	30.00		יח'	1,440.00	0.00	ש"ח	1,440.00	000	כללית - ריק
SO23000266	23/11/23	UP60B	UpLULA universal loader 9 - .45 - Black	126.00		יח'	6,048.00	0.00	ש"ח	6,048.00	000	כללית - ריק
SO23000266	23/11/23	UP60DG	UpLULA universal loader 9 - .45 - Dark Green	18.00		יח'	864.00	0.00	ש"ח	864.00	000	כללית - ריק
SO23000266	23/11/23	UP60BO	UpLULA universal loader 9 - .45 - Orange Brown	18.00		יח'	864.00	0.00	ש"ח	864.00	000	כללית - ריק
SO23000266	23/11/23	UP60L	UpLULA universal loader 9 - .45 - Lemon	30.00		יח'	1,440.00	0.00	ש"ח	1,440.00	000	כללית - ריק
SO23000293	25/12/23	UP60B	UpLULA universal loader 9 - .45 - Black	192.00	-114.00	יח'	9,216.00	-5,472.00	ש"ח	9,216.00	000	כללית - ריק
SO23000293	25/12/23	UP60DG	UpLULA universal loader 9 - .45 - Dark Green	36.00		יח'	1,728.00	0.00	ש"ח	1,728.00	000	כללית - ריק
SO23000293	25/12/23	UP60L	UpLULA universal loader 9 - .45 - Lemon	30.00		יח'	1,440.00	0.00	ש"ח	1,440.00	000	כללית - ריק
SO23000293	25/12/23	UP60BO	UpLULA universal loader 9 - .45 - Orange Brown	24.00		יח'	1,152.00	0.00	ש"ח	1,152.00	000	כללית - ריק
SO23000293	25/12/23	UP60PR	UpLULA universal loader 9 - .45 - Purple	36.00		יח'	1,728.00	0.00	ש"ח	1,728.00	000	כללית - ריק
SO23000293	25/12/23	UP60P	UpLULA universal loader 9 - .45 - Pink	24.00		יח'	1,152.00	0.00	ש"ח	1,152.00	000	כללית - ריק
SO24000027	25/01/24	UP60B	UpLULA universal loader 9 - .45 - Black	330.00	24.00	יח'	15,840.00	1,152.00	ש"ח	15,840.00	000	כללית - ריק
SO24000027	25/01/24	UP60DG	UpLULA universal loader 9 - .45 - Dark Green	54.00		יח'	2,592.00	0.00	ש"ח	2,592.00	000	כללית - ריק
SO24000027	25/01/24	UP60L	UpLULA universal loader 9 - .45 - Lemon	42.00		יח'	2,016.00	0.00	ש"ח	2,016.00	000	כללית - ריק
SO24000027	25/01/24	UP60BO	UpLULA universal loader 9 - .45 - Orange Brown	42.00		יח'	2,016.00	0.00	ש"ח	2,016.00	000	כללית - ריק

מאתאריך אספקה 01/01/20, עד תאריך אספקה 06/05/25, הזמנות פתוחות בלבד? N, מס. לקוח '100050', הזמנה ***, מק"ט *UP60, סוג הזמנה '000' =

הזמנות לפי לקוח

נכון לתקופה: 06/05/2025-01/01/2020

הזמנה	ת. אספקה	מק"ט	תאור מוצר	כמות	יתרה לאספקה	יח'	מחיר כולל	שווי יתרה	מטבע	מחיר כולל בשקלים	סוג הזמנה	תאור סוג הזמנה
SO24000027	25/01/24	UP60PR	UpLULA universal loader 9 - .45 - Purple	42.00		יח'	2,016.00	0.00	ש"ח	2,016.00	000	כללית - ריק
SO24000027	25/01/24	UP60P	UpLULA universal loader 9 - .45 - Pink	42.00		יח'	2,016.00	0.00	ש"ח	2,016.00	000	כללית - ריק
SO24000039	12/02/24	UP60B	UpLULA universal loader 9 - .45 - Black	102.00		יח'	4,896.00	0.00	ש"ח	4,896.00	000	כללית - ריק
SO24000049	21/02/24	UP60B	UpLULA universal loader 9 - .45 - Black	288.00		יח'	13,824.00	0.00	ש"ח	13,824.00	000	כללית - ריק
SO24000049	21/02/24	UP60DG	UpLULA universal loader 9 - .45 - Dark Green	18.00		יח'	864.00	0.00	ש"ח	864.00	000	כללית - ריק
SO24000049	21/02/24	UP60BO	UpLULA universal loader 9 - .45 - Orange Brown	18.00		יח'	864.00	0.00	ש"ח	864.00	000	כללית - ריק
SO24000049	21/02/24	UP60L	UpLULA universal loader 9 - .45 - Lemon	24.00		יח'	1,152.00	0.00	ש"ח	1,152.00	000	כללית - ריק
SO24000049	21/02/24	UP60P	UpLULA universal loader 9 - .45 - Pink	18.00		יח'	864.00	0.00	ש"ח	864.00	000	כללית - ריק
SO24000049	21/02/24	UP60PR	UpLULA universal loader 9 - .45 - Purple	18.00		יח'	864.00	0.00	ש"ח	864.00	000	כללית - ריק
SO24000071	27/03/24	UP60B	UpLULA universal loader 9 - .45 - Black	192.00		יח'	9,216.00	0.00	ש"ח	9,216.00	000	כללית - ריק
SO24000107	09/05/24	UP60B	UpLULA universal loader 9 - .45 - Black	192.00		יח'	9,216.00	0.00	ש"ח	9,216.00	000	כללית - ריק
SO24000122	30/05/24	UP60B	UpLULA universal loader 9 - .45 - Black	384.00	-54.00	יח'	18,432.00	-2,592.00	ש"ח	18,432.00	000	כללית - ריק
SO24000122	30/05/24	UP60L	UpLULA universal loader 9 - .45 - Lemon	54.00		יח'	2,592.00	0.00	ש"ח	2,592.00	000	כללית - ריק
SO24000122	30/05/24	UP60PR	UpLULA universal loader 9 - .45 - Purple	24.00		יח'	1,152.00	0.00	ש"ח	1,152.00	000	כללית - ריק
SO24000122	30/05/24	UP60P	UpLULA universal loader 9 - .45 - Pink	30.00		יח'	1,440.00	0.00	ש"ח	1,440.00	000	כללית - ריק
SO24000122	30/05/24	UP60BO	UpLULA universal loader 9 - .45 - Orange Brown	12.00		יח'	576.00	0.00	ש"ח	576.00	000	כללית - ריק
SO24000122	30/05/24	UP60DG	UpLULA universal loader 9 - .45 - Dark Green	6.00		יח'	288.00	0.00	ש"ח	288.00	000	כללית - ריק
SO24000148	11/07/24	UP60B	UpLULA universal loader 9 - .45 - Black	300.00	-12.00	יח'	14,400.00	-576.00	ש"ח	14,400.00	000	כללית - ריק
SO24000148	11/07/24	UP60PR	UpLULA universal loader 9 - .45 - Purple	24.00		יח'	1,152.00	0.00	ש"ח	1,152.00	000	כללית - ריק
SO24000148	11/07/24	UP60BO	UpLULA universal loader 9 - .45 - Orange Brown	24.00		יח'	1,152.00	0.00	ש"ח	1,152.00	000	כללית - ריק
SO24000148	11/07/24	UP60DG	UpLULA universal loader 9 - .45 - Dark Green	12.00		יח'	576.00	0.00	ש"ח	576.00	000	כללית - ריק
SO24000165	05/08/24	UP60B	UpLULA universal loader 9 - .45 - Black	312.00		יח'	14,976.00	0.00	ש"ח	14,976.00	000	כללית - ריק
SO24000165	05/08/24	UP60DG	UpLULA universal loader 9 - .45 - Dark Green	18.00		יח'	864.00	0.00	ש"ח	864.00	000	כללית - ריק
SO24000165	05/08/24	UP60BO	UpLULA universal loader 9 - .45 - Orange Brown	42.00		יח'	2,016.00	0.00	ש"ח	2,016.00	000	כללית - ריק
SO24000165	05/08/24	UP60L	UpLULA universal loader 9 - .45 - Lemon	36.00		יח'	1,728.00	0.00	ש"ח	1,728.00	000	כללית - ריק
SO24000165	05/08/24	UP60PR	UpLULA universal loader 9 - .45 - Purple	54.00		יח'	2,592.00	0.00	ש"ח	2,592.00	000	כללית - ריק
SO24000207	22/09/24	UP60L	UpLULA universal loader 9 - .45 - Lemon	84.00		יח'	4,032.00	0.00	ש"ח	4,032.00	000	כללית - ריק
SO24000207	22/09/24	UP60PR	UpLULA universal loader 9 - .45 - Purple	84.00		יח'	4,032.00	0.00	ש"ח	4,032.00	000	כללית - ריק
SO24000207	22/09/24	UP60BO	UpLULA universal loader 9 - .45 - Orange Brown	84.00		יח'	4,032.00	0.00	ש"ח	4,032.00	000	כללית - ריק
SO24000207	22/09/24	UP60DG	UpLULA universal loader 9 - .45 - Dark Green	84.00		יח'	4,032.00	0.00	ש"ח	4,032.00	000	כללית - ריק
SO24000207	22/09/24	UP60US	UpLULA universal loader 9 - .45 - US Flag	84.00		יח'	4,032.00	0.00	ש"ח	4,032.00	000	כללית - ריק
SO24000207	22/09/24	UP60P	UpLULA universal loader 9 - .45 - Pink	84.00		יח'	4,032.00	0.00	ש"ח	4,032.00	000	כללית - ריק
SO24000221	01/10/24	UP60B	UpLULA universal loader 9 - .45 - Black	192.00		יח'	9,216.00	0.00	ש"ח	9,216.00	000	כללית - ריק
SO24000221	01/10/24	UP60DG	UpLULA universal loader 9 - .45 - Dark Green	84.00		יח'	4,032.00	0.00	ש"ח	4,032.00	000	כללית - ריק
SO24000221	01/10/24	UP60P	UpLULA universal loader 9 - .45 - Pink	30.00		יח'	1,440.00	0.00	ש"ח	1,440.00	000	כללית - ריק

מתאריך אספקה 01/01/20, עד תאריך אספקה 06/05/25, הזמנות פתוחות בלבד? N, מס. לקוח '100050', הזמנה **', מק"ט 'UP60', סוג הזמנה '000' =

הזמנות לפי לקוח

נכון לתקופה: 06/05/2025-01/01/2020

הזמנה	ת. אספקה	מק"ט	תאור מוצר	כמות	יתרה לאספקה	יח'	מחיר כולל	שווי יתרה	מטבע	מחיר כולל בשקלים	סוג הזמנה	תאור סוג הזמנה
SO24000221	01/10/24	UP60BO	UpLULA universal loader 9 - .45 - Orange Brown	30.00		יח'	1,440.00	0.00	ש"ח	1,440.00	000	כללית - ריק
SO24000221	01/10/24	UP60PR	UpLULA universal loader 9 - .45 - Purple	30.00		יח'	1,440.00	0.00	ש"ח	1,440.00	000	כללית - ריק
SO24000221	01/10/24	UP60L	UpLULA universal loader 9 - .45 - Lemon	30.00		יח'	1,440.00	0.00	ש"ח	1,440.00	000	כללית - ריק
SO24000288	29/12/24	UP60P	UpLULA universal loader 9 - .45 - Pink	18.00		יח'	864.00	0.00	ש"ח	864.00	000	כללית - ריק
SO24000288	29/12/24	UP60DG	UpLULA universal loader 9 - .45 - Dark Green	18.00		יח'	864.00	0.00	ש"ח	864.00	000	כללית - ריק
SO24000288	29/12/24	UP60BO	UpLULA universal loader 9 - .45 - Orange Brown	12.00		יח'	576.00	0.00	ש"ח	576.00	000	כללית - ריק
SO24000288	29/12/24	UP60PR	UpLULA universal loader 9 - .45 - Purple	18.00		יח'	864.00	0.00	ש"ח	864.00	000	כללית - ריק
SO24000288	29/12/24	UP60L	UpLULA universal loader 9 - .45 - Lemon	12.00		יח'	576.00	0.00	ש"ח	576.00	000	כללית - ריק
SO24000288	29/12/24	UP60B	UpLULA universal loader 9 - .45 - Black	242.00	-46.00	יח'	11,616.00	-2,208.00	ש"ח	11,616.00	000	כללית - ריק
SO24000288	29/12/24	UP60US	UpLULA universal loader 9 - .45 - US Flag	18.00		יח'	864.00	0.00	ש"ח	864.00	000	כללית - ריק
SO25000009	13/01/25	UP60B	UpLULA universal loader 9 - .45 - Black	192.00		יח'	9,216.00	0.00	ש"ח	9,216.00	000	כללית - ריק
SO25000089	05/05/25	UP60B	UpLULA universal loader 9 - .45 - Black	240.00	6.00	יח'	11,520.00	288.00	ש"ח	11,520.00	000	כללית - ריק
SO25000089	05/05/25	UP60DG	UpLULA universal loader 9 - .45 - Dark Green	30.00		יח'	1,440.00	0.00	ש"ח	1,440.00	000	כללית - ריק
SO25000089	05/05/25	UP60BO	UpLULA universal loader 9 - .45 - Orange Brown	30.00		יח'	1,440.00	0.00	ש"ח	1,440.00	000	כללית - ריק
SO25000089	05/05/25	UP60L	UpLULA universal loader 9 - .45 - Lemon	30.00		יח'	1,440.00	0.00	ש"ח	1,440.00	000	כללית - ריק
SO25000089	05/05/25	UP60PR	UpLULA universal loader 9 - .45 - Purple	30.00		יח'	1,440.00	0.00	ש"ח	1,440.00	000	כללית - ריק
SO25000089	05/05/25	UP60P	UpLULA universal loader 9 - .45 - Pink	30.00		יח'	1,440.00	0.00	ש"ח	1,440.00	000	כללית - ריק
										369,024.00		
										369,024.00	סה"כ למס. לקוח: 100050	
											סה"כ כלי	

World's #1

Magazine Loaders and UnLoaders

Tools for Professionals !

- ✓ Save time
- ✓ No more pain
- ✓ Protect the feed lips
- ✓ Military quality

LULA® Loader & UnLoader

(US patent 6,810,616)

- AR-15 / M-16 (5.56) p/n 24215
- AK-47 & Galil (7.62 & 5.56) p/n 24216
- M1A / M14 (.308) p/n 24220
- FN FAL (.308) p/n 24221
- MP5 (9mm) p/n 24217
- Colt SMG (9mm) p/n 24218
- UZI (9mm) p/n 24219



StripLULA™ AR-15 / M-16 Stripper Clip Loader

(US and Intl. patents pending)

- Easily and quickly load rounds from 10-round stripper clips into AR-15 / M-16 (5.56) magazines.
- Fingers do not touch the rounds.
- 1/3 of the size of other loaders. p/n 24200



UpLULA™ Universal Pistol Loader

(US and Intl. patents pending)

- One size fits all, no inserts or adjustments.
- Loads virtually all 9mm, .357, 10mm, .40, and .45 cal rounds and magazines.
- Fits both single & double stack mags of all manufacturers !
- One SKU. p/n 24222



BenchLoader™ Heavy Duty 30-round Loader (5.56)

(US patent 7,059,077)

- AR-15 / M-16 p/n 24225
- HK 416 / SA-80 & AR-15 / M-16 p/n 24226
- HK G36 p/n 24227
- Steyr AUG & AR-15 / M-16 p/n 24229
- Galil p/n 24228



maglula Ltd.

Watch video clips and read testimonials at www.maglula.com

Distributed by:  Tel: (913) 752-3400

© 2007 maglula Ltd., Israel

UpLULA™

Universal Pistol Magazine Loader

Load them all:

- Beretta
 - Browning
 - Colt
 - CZ
 - FN
 - Glock
 - HK
 - Kimber
 - Para Ordnance
 - Ruger
 - Sig / Sauer
 - S&W
 - Springfield Armory
 - STI Int.
 - Taurus
 - Walter
- and many more.



p/n 24222

- One size fits all.
- Loads all 9mm to .45 cal. rds. and mags.
- Fits both single and double-stack mags.
- Fits mags of all manufacturers.
- Easy and quick loading.
- Highly durable.
- One SKU.

LULA®

Magazine Loader & UnLoader

M16 / AR15
5.56 (.223)



p/n 24215

AK47 / Galil
7.62 / 5.56



p/n 24216

MP5
9mm



p/n 24217

M1A/M14
.308



p/n 24220

COLT SMG
9mm



p/n 24218

FAL
.308



p/n 24221

UZI
9mm



p/n 24219

Made by
maglula Ltd.
US pat. 6,810,616
more patents pend.
Watch video clips at
www.maglula.com

US distributor:

Bushnell Outdoor Products

Tel: (913) 752-3400

©

For professionals !

UpLULA™

Universal Pistol Magazine Loader

Load them all:

- Beretta
- Browning
- Colt
- CZ
- FN
- Glock
- HK
- Kimber
- Para Ordnance
- Ruger
- Sig / Sauer
- S&W
- Springfield Armory
- STI Int.
- Taurus
- Walter
- and many more.



- Highly durable.
- One size fits all.
- Loads all 9mm to .45 cal. rds. and mags.
- Fits both single and double-stack mags.
- Fits mags of all manufacturers.
- Easy and quick loading.
- One SKU.

"The UpLULA is the best Glock gadget I've seen in years. With only a few minutes practice I was able to load an 18 round G17 magazine in record time." Scott Greenbaum, GlockFAQ.com FL, Jan. 3, 2007

"... guys at the range who liked the UpLULA so much they were literally standing in line to use it. Eight of the shooters loaded 2000 rounds each and couldn't keep their hands off it." Andrew Schwartz, Shooter, FL, Jan. 22, 2007

LULA®

Magazine Loader & UnLoader

	M16 / AR15 5.56 (.223) p/n 24215
	AK47 / Galil 7.62 / 5.56 p/n 24216
	M1A / M14 .308 p/n 24220
	FN FAL .308 p/n 24221
	COLT SMG 9mm p/n 24218
	MP5 9mm p/n 24217
	UZI 9mm p/n 24219



maglula Ltd.

Watch video clips and read testimonials at www.maglula.com

Distributed under:  Tel: (913) 752-3400



© 2007 maglula Ltd. US pat. 6,810,616; Intl. patents pend.

Tools for Professionals !

Save time and pain at the range



UpLULA™

9mm to .45

Universal Pistol Loader

US distributor:



Tel: (913) 752-3400

maglula Ltd. Made in Israel
US patents 6,810,616 & 7,059,077
US & Intl. patents pending



AR-15 / M-16

LULA™

loader & unloader



AR-15 / M-16 BenchLoader™

Copyright 2007 © maglula Ltd. LULA™, UpLULA™ and BenchLoader™ are trademarks of maglula Ltd.

Ammo shortage ?

We apologize.



www.maglula.com

maglula



World's #1 mag loaders !



Ammo shortage ?

We apologize



UpLULA™
p/n UP60B



LULA™
p/n LU10B



StripLULA™
p/n SL50B



XT-LULA™
p/n XT83B



**Range
BenchLoader™**
p/n BL71B

World's #1 mag loaders !

maglula

www.maglula.com

Shipping

SIG MPX™

9mm LULA™ magazine loader & unloader



p/n LU19B

SIG MPX is a trademark of SigSauer.

New **UpLULA™** colors - Purple, Lemon, Green, OrangeBrn



p/n UP60PR



p/n UP60L



p/n UP60DG



p/n UP60BO

Range

BenchLoader™

Heavy-duty 30-round loader

for all metal & polymer 5.56/.223 AR15 / M4 mags.

MSRP \$149



p/n BL71B

All products are patented and trademarked, owned by maglula Ltd., Israel

World's #1 magazine loaders !

maglula Ltd.

Range

MSRP \$149

BenchLoader™

Heavy-duty 30-round loader

for all metal & polymer 5.56/.223 AR15 / M4 mags.
p/n BL71B

Now available!

SIG MPX™

9mm LULA™ magazine loader & unloader
p/n LU19B



New

UpLULA™ colors - Purple, Lemon, Green, OrangeBrn



p/n UP60PR



p/n UP60L



p/n UP60DG



p/n UP60BO

U.S. Pat. 7,059,077; Design Pat. D728,065 BenchLoader is a trademark of maglula Ltd.

MPX is a trademark of SigSauer.

World's #1 loaders !

maglula Ltd.

May 2017

CZ Scorpion™

9mm **LULA** magazine loader & unloader
p/n LU17B

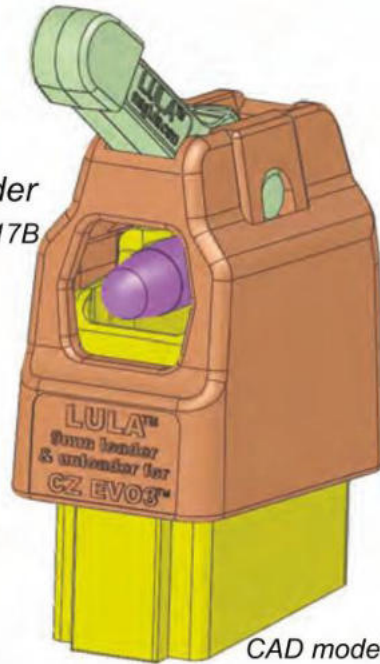

LULA & UpLULA are trademarks of maglula Ltd.

Now available!

SIG MPX™

9mm **LULA™** magazine loader & unloader
p/n LU19B



CAD model

MPX is a trademark of SigSauer. Scorpion is a trademark of CZ Inc.

Now available!

New **UpLULA™** colors - Purple, Lemon, Green, OrangeBrn



p/n UP60PR



p/n UP60L



p/n UP60DG



p/n UP60BO

World's #1 loaders !

maglula Ltd.

July 2017



CAD model

AR15 7.62x39

LULA™ magazine loader & unloader
p/n LU11B

May 2017

CZ Scorpion™

9mm **LULA™** magazine loader & unloader
p/n LU17B



CAD model

Now available!



SIG MPX™

9mm **LULA™** magazine loader & unloader
p/n LU19B

UpLULA™ colors - Purple, Lemon, Green, OrangeBrn



p/n UP60PR



p/n UP60L



p/n UP60DG



p/n UP60BO

LULA & UpLULA are a trademarks of maglula Ltd.

Scorpion is a trademark of CZ Inc. MPX is a trademark of SigSauer.

World's #1 loaders !

maglula Ltd.

Dec. 2017



CAD model

AR15 7.62x39

LULA™ magazine loader & unloader
p/n LU11B

Available now!

CZ Scorpion EVO3™

9mm **LULA™** magazine loader & unloader
p/n LU17B



Available now!



SIG MPX™

9mm **LULA™** magazine loader & unloader
p/n LU19B

UpLULA™ colors - Purple, Lemon, Green, OrangeBrn



p/n UP60PR



p/n UP60L



p/n UP60DG



p/n UP60BO

LULA & UpLULA are a trademarks of maglula Ltd. Scorpion EVO3 is a trademark of CZ Inc. MPX is a trademark of SigSauer.

World's #1 loaders !

maglula Ltd.

UpLULA®

9mm - .45ACP universal
pistol magazine loader
& unloader



UP60B

Available colors



- Fits single & double-stack mags
- Painless loading & unloading
- Highly reliable, lightweight
- Works like a champ, for years !

AR15 LULA®

5.56 / .223 loader & unloader



LU10DG

**World's best selling
magazine loaders !**

Over thirty professional pistol & rifle
mag loaders - Made in Israel

Ask your local dealer

maglula Ltd.
Since 2001

maglula.com

AR15 LULA®

5.56 / .223 mag loader & unloader

New!
DarkGreen



p/n LU10DG



No more pain!

UpLULA®

9mm - .45ACP universal
pistol magazine loader



p/n UP60B

World's
#1
Loaders!

Available colors
● ● ● ● ●

Range BenchLoader®

Heavy-duty 30-round loader
5.56 / .223 AR15 / M4 mags



p/n BL71B

World's #1 selection of magazine loaders !

Professional pistol & rifle mag loaders

Ask your distributor

maglula Ltd.

maglula.com

U.S. Patented LULA and BenchLoader are registered trademarks of maglula Ltd.

Maglula Ltd.

Professional Magazine Loaders and UnLoaders

maglula Ltd.

World's #1 loaders!

StripLULA™

M16 / AR15 Stripper Clip & Loose Rounds Magazine Loader

- Stripper clip mag loader.
- Ten loose rounds mag loader.
- A simple unloader too.
- Fits all M16 / AR15 5.56 metal and polymer mags.
- 1/3 the size and weight of competing loaders.
- Easy & quick loading.
- Highly durable.



Placing a stripper clip.

Placing loose rounds.

No more pain!

LULA^R

Loader & UnLoader



M16 / AR15 5.56



M1A / M14 .308



AK47 & Galil 7.62 / 5.56



FN FAL .308



MP5 9mm



COLT SMG 9mm



UZI 9mm

UpLULA™

Universal Pistol Magazine Loader

- One size fits all. No inserts or adjustments.
- Loads virtually all 9mm to .45 cal rounds & mags.
- Fits both single and double stack mags.
- Fits mags of all manufacturers.
- Easy & quick loading.
- Highly durable.
- One SKU.



Real Saver!

Load hundreds of rounds, painlessly!

BenchLoader™



HK416/SA80 & M16 5.56

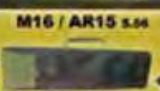

Padded case (included)



Steyr AUG & M16 5.56



HK G36 5.56



Galil 5.56

US distributor:



Tel: (913) 752-3400

maglula Ltd.

Made in Israel
www.maglula.com
US patents 6,810,616 & 7,059,077
US & Intl. patents pending

Copyright © 2005 Maglula Ltd. All rights reserved.

maglula Loaders & unloaders

Over 16,000 five-star reviews online!



World's #1 Loaders!
Since 2001

US pat. 6,810,616
NSN: 1005310167375



LULA®
Individual-round loader & unloader

US pat. 7,805,874
NSN: 1005310167299



StripLULA™
10-round loader for stripper-clips and loose rds.

US pat. 7,059,077
US pat. D728,065
NSN: 1005310173431



BenchLoader®
30-round heavy-duty loader for armories & ranges

US pat. pending



2018 new!
10/22® BX LULA®
loader & unloader

US pats. 7,637,048 & 7,503,138
Design copyrighted



UpLULA™
NSN: 1005310172705



BabyUpLULA®



22UpLULA®



1911AI®



T12-LULA®

US pat. 8,012,859
US pat. D700,266
US pat. 9,057,570



X10 & V10-LULA®

RIFLE mag. loaders & unloaders

.22LR mags.

- Ruger factory 10/22 BX LULA® loader & unloader set LU30B **2018**
- 10/22-type mag unloader LU32B **New!**

5.56 x 45 / .223 mags.

- AR15 / M16 LULA® loader & unloader LU10B
- Galil LULA® loader & unloader LU12B
- AR15 / M16 StripLULA™ loader* SL50B
- Mini 14 StripLULA™ loader SL52B
- Steyr AUG StripLULA™ loader* SL54B **2018**



- AR15 / M4, PMAG Range BenchLoader® loader BL71B **Revised!**
- HK G36 & Pmag BenchLoader® loader BL74B
- Galil BenchLoader® loader BL76B
- Steyr AUG & AR15 / M16 BenchLoader® loader BL78B

7.62 x 39 mags.

- AR15 LULA® loader & unloader LU11B **2018**
- AK47 LULA® loader & unloader LU12B

7.62 x 51 / .308 mags.

- SR25 / DPMS LULA® loader & unloader LU21B
- AR10B Gen. II LULA® loader & unloader LU23B
- SCAR H / 17 LULA® loader & unloader LU24B
- HK91 / G3 LULA® loader & unloader LU25B
- M1A / M14 LULA® loader & unloader LU20B
- FAL LULA® loader & unloader LU22B

9mm x 19 SMG mags.

- MP5 LULA® loader & unloader LU14B
- COLT SMG LULA® loader & unloader LU16B
- UZI LULA® loader & unloader LU18B
- MPX LULA® loader & unloader LU19B
- CZ Scorpion EVO3 LULA® loader & unloader LU17B **New!**

PISTOL mag. loaders & unloaders

.22LR mags. (with a projecting side-button)

- V10-LULA® & X10-LULA® loaders set for .22LR single-stack narrow-body mags with a projecting side-button. XV80B
 - Ruger MK I, II, III, 22/45, • Browning BuckMark/Challenger, • Beretta U22 NEOS,
 - COLT Woodsman/Cadet, • High Standard .22, • S&W 22A/22S (only X10-LULA).
- T12-LULA® & X12-LULA® loaders set for .22LR single-stack wider-body mags with a projecting side-button. XT83B
 - Walther P22/G22, • Ruger SR22, • S&W M&P .22, • COLT 1911 .22,
 - Walther PPK/S .22 (Only T12-LULA)

.22LR to .380ACP mags. (without a projecting side-button)

- BabyUpLULA® universal* loader & unloader for single-stack narrow-body mags < 1/2". UP64B ● UP64P ●

.22LR Converted mags.

- 22UpLULA® universal* loader & unloader for .22LR converted single and double stack mags. UP62B

9mm to .45ACP mags.

- UpLULA™ universal* loader & unloader for 9mm to .45 single & double stack mags of all manufactures. UP60B, UP60P, UP60DG, UP60BO, UP60L, UP60PR

1911AI Aligner Insert

- Aligner insert for assisting loading single-stack mags in the UpLULA™ and 22UpLULA® pistol mag. loaders. Eliminates mag wiggling. UP65G

- Notes:
1. Few mags may not load properly, see web site.
 2. Actual product color may vary slightly.
 3. Some loaders are patented also in Israel and Canada.

CAGE: 2899A

US Distributors

- AcuSport
- AmChar
- Bangers
- Big Rock Sports
- Bill Hicks
- Ellett Brothers
- Green Supply
- Gun Accessory Sup.
- Jerry's Sports Center
- Kroll International
- MGE Wholesale
- North Sylva
- Riley's
- RSR
- Sportsman's Supply
- Sports South
- Tactical Gear Dist.
- Williams Shooters S.
- W.L. Baumer Co.
- Zanders

ADS, TSSI



maglula Ltd.
www.maglula.com

© 2018/1 maglula Ltd., Israel. All invented, designed and manufactured in Israel.

New !

World's
7
Loaders!
Since 2001

AR15 / M4 LULA®
5.56 / .223 magazine
loader & unloader



Dark Green

LU10DG

Red-White-Blue UpLULA®
Celebrating 20 years
of painless loading in the USA



UP60US



Counter-top display tray
for 12 x UpLULA®

Colors may change slightly.



PDQ12UP
Ask your distributor



Featuring...

AR15 / M4 5.56 / .223
Range
BenchLoader®
Heavy-duty 30-round magazine loader

US pat. 7,059,077
US pat. D728,065

NSN: 1005310173431



BL71B

Fits:

- All AR15 / M4 compatible 5.56 x 45 NATO / .223 mags., as:
- USGI Aluminum (NATO STANAG 4179)
- Polymer mags (PMAG and all others)

- Does not load blank rounds.

GSA Advantage!

maglula Ltd.
www.maglula.com

© 2021/12 maglula Ltd., Israel All invented, designed and manufactured in Israel. Trademarks are held by their respective owners.

maglula® Loaders & unloaders

Highest rated mag loaders ever!



20 yrs
Special edition

World's
#1
Loaders!
Since 2001

US pat. 6,810,616
NSN: 1005310167375

US pat. 7,805,874
NSN: 1005310167299

US pat. 7,059,077
US pat. D728,065
NSN: 1005310173431

US pat. 10,598,456
US pat. D672217



LULA®
Individual-round
loader & unloader



StripLULA®
10-round loader for
stripper-clips and loose rds.



BenchLoader®
30-round heavy-duty loader
for armories & ranges



**10/22® BX
LULA®**
loader & unloader



UpLULA®
NSN: 1005310172705



BabyUpLULA®



22UpLULA®



1911AI®



T12-LULA®



X10 & V10-LULA®

- .22LR & .22WMR mags.**
- Ruger factory 10/22 BX **LULA®** loader & unloader set LU30B
 - 10/22-type mag unloader LU32B
 - PMR-30 .22WMR mag loader & unloader LU34B US pat. 11,029,108
- 5.56 x 45 / .223 mags.**
- AR15 / M4 **LULA®** loader & unloader LU10B, LU10DG
 - Galil **LULA®** loader & unloader LU12B
 - AR15 / M4 **StripLULA®** loader* SL50B
 - Mini 14 **StripLULA®** loader SL52B
 - Steyr AUG **StripLULA®** loader* SL54B
 - AR15 / M4, PMAG Range **BenchLoader®** loader BL71B
 - HK G36 & Pmag **BenchLoader®** loader BL74B, BL74BP
 - Galil **BenchLoader®** loader BL76B
 - Steyr AUG & AR15 / M4 **BenchLoader®** loader BL78B
- 7.62 x 39 mags.**
- AR15 **LULA®** loader & unloader LU11B
 - AK47 **LULA®** loader & unloader LU12B
- 7.62 x 51 / .308 mags.**
- SR25 / DPMS **LULA®** loader & unloader LU21B
 - AR10B Gen. II **LULA®** loader & unloader LU23B
 - SCAR H / 17 **LULA®** loader & unloader LU24B
 - HK91 / G3 **LULA®** loader & unloader LU25B
 - M1A / M14 **LULA®** loader & unloader LU20B
 - FAL **LULA®** loader & unloader LU22B
- 9mm x 19 SMG mags.**
- MP5 **LULA®** loader & unloader LU14B
 - COLT SMG **LULA®** loader & unloader LU16B
 - UZI **LULA®** loader & unloader LU18B
 - MPX **LULA®** loader & unloader LU19B
 - CZ Scorpion EVO3 **LULA®** loader & unloader LU17B

RIFLE mag. loaders & unloaders

GSA Advantage!

- .22LR mags. (with a projecting side-button)**
- **V10-LULA® & X10-LULA®** loaders set for .22LR single-stack narrow-body mags with a projecting side-button. **XV80B**
 - Ruger MK I, II, III, 22/45, • Browning BuckMark/Challenger, • Beretta U22 NEOS, • COLT Woodsman/Cadet, • High Standard .22, • S&W 22A/22S (only X10-LULA).
 - **T12-LULA® & X12-LULA®** loaders set for .22LR single-stack wider-body mags with a projecting side-button. **XT83B**
 - Walther P22/G22, • Ruger SR22, • S&W M&P .22, • COLT 1911 .22, • Walther PPK/S .22 (Only T12-LULA)
- .22LR to .380ACP mags. (without a projecting side-button)**
- **BabyUpLULA®** universal* loader & unloader for single-stack narrow-body mags < 1/2". **UP64B** **UP64P**
- .22LR Converted mags.**
- **22UpLULA®** universal* loader & unloader for .22LR converted single and double stack mags. **UP62B**
- 9mm to .45ACP mags.**
- **UpLULA®** universal loader & unloader for 9mm to .45 single & double stack mags of all manufactures. **UP60B, UP60P, UP60DG, UP60BO, UP60L, UP60PR, UP60US**
- 1911AI Aligner Insert**
- Aligner insert for assisting loading single-stack mags in the **UpLULA®** and **22UpLULA®** pistol mag. loaders. Eliminates mag wiggling. **UP65G**

PISTOL mag. loaders & unloaders

Notes: 1. Few mags may not load properly, see web site.
2. Actual product color may vary slightly.
3. Some loaders are patented also in Israel and Canada.

CAGE: 2899A

US Distributors

- AmChar
- Bangers
- Big Rock Sports
- Bill Hicks
- Camfour
- Chattanooga
- Crow
- Davidson's
- Gun Accessory Sup.
- Hicks
- Hill Country
- Kroll International
- MGE Wholesale
- North Sylva (Canada)
- Riley's
- RSR
- Sports South
- Tactical Gear Dist.
- Zanders

ADS
HL Dalis



maglula Ltd.
www.maglula.com

All invented, designed and manufactured in Israel © 2021 / 12 maglula Ltd., Israel

maglula Loaders & Unloaders

World's #1 Loaders
Since 2001

US pat. #6,810,616 US pat. #7,805,874

US pat. #7,059,077



LULA®
Individual-round loader & unloader

StripLULA™
10-round loader & unloader for stripper clips and loose rounds

BenchLoader™
30-round heavy-duty loader for armories & ranges

US pats. #7,637,048 & #7,503,138

US pat. pending US pats. pending



UpLULA™

BabyUpLULA™

22UpLULA™

1911AI™

T12-LULA™

X10 & V10-LULA™

RIFLE mag. loaders & unloaders

5.56 x 45 / .223 mags.

- AR15 / M16 **LULA®** loader & unloader LU10B (24215)
- Galil **LULA®** loader & unloader LU12B (24216)
- AR15 / M16 **StripLULA™** loader & unloader SL50B (24200)
- Mini 14 **StripLULA™** loader & unloader SL52B (24201)
- AR15 / M16 **BenchLoader™** loader BL70B (24225)
- AR15 / M16, HK 416 / SA80, PMAG **BenchLoader™** loader BL72B
- HK G36 **BenchLoader™** loader BL74B
- Galil **BenchLoader™** loader BL76B (24228)
- Steyr AUG & AR15 / M16 **BenchLoader™** loader BL78 (24229)

7.62 x 39 mags.

- AK47 **LULA®** loader & unloader LU12B (24216)

7.62 x 51 / .308 mags.

- SR25 / DPMS **LULA®** loader & unloader LU21B (24315)
- AR10B Gen. II **LULA®** loader & unloader LU23B (24310)
- SCAR H / 17 **LULA®** loader & unloader LU24B (24321)
- HK91 / G3 **LULA®** loader & unloader LU25B (24322)
- M1A / M14 **LULA®** loader & unloader LU20B (24220)
- FAL **LULA®** loader & unloader LU22B (24221)

9mm x 19 SMG mags.

- MP5 **LULA®** loader & unloader LU14B (24217)
- COLT SMG **LULA®** loader & unloader LU16B (24218)
- UZI **LULA®** loader & unloader LU18B (24219)

New!
New!
New!

PISTOL mag. loaders & unloaders

.22LR mags. (with a projecting side-button)

- **V10-LULA™** & **X10-LULA™** loaders set for .22LR single-stack narrow-body mags with a projecting side-button. XV80B (24236)
Ruger MK I, II, III, 22/45, Browning BuckMark/Challenger, Beretta U22 NEOS, COLT Woodsman/Cadet, High Standard .22, S&W 22A/22S (only X10-LULA).

- **T12-LULA™** & **X12-LULA™** loaders set for .22LR single-stack wider-body mags with a projecting side-button. XT83B (24238)
Walther P22/G22, Ruger SR22, S&W M&P .22, COLT 1911 .22, Walther PPK/S .22 (Only T12-LULA)

.22LR to .380ACP mags. (without a projecting side-button)

- **BabyUpLULA™** universal* loader & unloader for single-stack narrow-body mags < 1/2". UP64B (24223), ● UP64P (24223P)

.22LR Converted mags.

- **22UpLULA™** universal* loader & unloader for .22LR converted single and double stack mags. UP62B (24224)

9mm to .45ACP mags.

- **UpLULA™** universal* loader & unloader for 9mm to .45 single and double stack mags of all manufactures. UP60B (24222), ● UP60P (24222P)

1911AI Aligner Insert

- Aligner insert for assisting loading single-stack mags in the UpLULA™ and **22UpLULA™** pistol mag. loaders. Eliminates mag. wiggling. UP65G (24235)

New!

New!

New!

New!

Distributors



RSR
Ellett Brothers
Sport South
Big Rock Sports
AcuSport
and many more.



All invented, designed and manufactured in Israel

© 2014 maglula Ltd., Israel

maglula p/n (Bushnell p/n)
* Few mags are out of range. See web site.
Patented also in Israel and Canada

maglula Ltd.
www.maglula.com

World's #1

Magazine Loaders and UnLoaders

Tools for Professionals !

- ✓ Save time
- ✓ No more pain
- ✓ Protect the feed lips
- ✓ Military quality

LULA® Loader & UnLoader

(US patent 6,810,616)

- AR-15 / M-16 (5.56) p/n 24215
- AK-47 & Galil (7.62 & 5.56) p/n 24216
- M1A / M14 (.308) p/n 24220
- FN FAL (.308) p/n 24221
- MP5 (9mm) p/n 24217
- Colt SMG (9mm) p/n 24218
- UZI (9mm) p/n 24219



StripLULA™ AR-15 / M-16 Stripper Clip Loader

(US and Intl. patents pending)

- Easily and quickly load rounds from 10-round stripper clips into AR-15 / M-16 (5.56) magazines.
- Fingers do not touch the rounds.
- 1/3 of the size of other loaders. p/n 24220



UpLULA™ Universal Pistol Loader

(US and Intl. patents pending)

- One size fits all, no inserts or adjustments.
- Loads virtually all 9mm, .357, 10mm, .40, and .45 cal rounds and magazines.
- Fits both single & double stack mags of all manufacturers !
- One SKU. p/n 24222



BenchLoader™

Heavy Duty 30-round Loader (5.56)

(US patent 7,059,077)

- AR-15 / M-16 p/n 24225
- HK 416 / SA-80 & AR-15 / M-16 p/n 24226
- HK G36 p/n 24227
- Steyr AUG & AR-15 / M-16 p/n 24229
- Galil p/n 24228



maglula Ltd.

Watch video clips and read testimonials at www.maglula.com

Distributed by:  Tel: (913) 752-3400

© 2007 maglula Ltd., Israel

Save time and pain at the range



UpLULA™

9mm to .45

Universal Pistol Loader



**AR-15 / M-16
LULA™
loader & unloader**

US distributor:



Tel: (913) 752-3400

maglula Ltd. Made in Israel
US patents 6,810,616 & 7,059,077
US & Intl. patents pending



AR-15 / M-16 BenchLoader™

Ammo shortage ?

We apologize.



www.maglula.com

maglula



World's #1 mag loaders !



Ammo shortage ?

We apologize



UpLULA™
p/n UP60B



LULA™
p/n LU10B



StripLULA™
p/n SL50B



XT-LULA™
p/n XT83B



**Range
BenchLoader™**
p/n BL71B

World's #1 mag loaders !

maglula

www.maglula.com

Shipping

SIG MPX™

9mm LULA™ magazine loader & unloader



p/n LU19B

SIG MPX is a trademark of SigSauer.

New **UpLULA™** colors - Purple, Lemon, Green, OrangeBrn



p/n UP60PR



p/n UP60L



p/n UP60DG



p/n UP60BO

Range

BenchLoader™

Heavy-duty 30-round loader

for all metal & polymer 5.56/.223 AR15 / M4 mags.

MSRP \$149

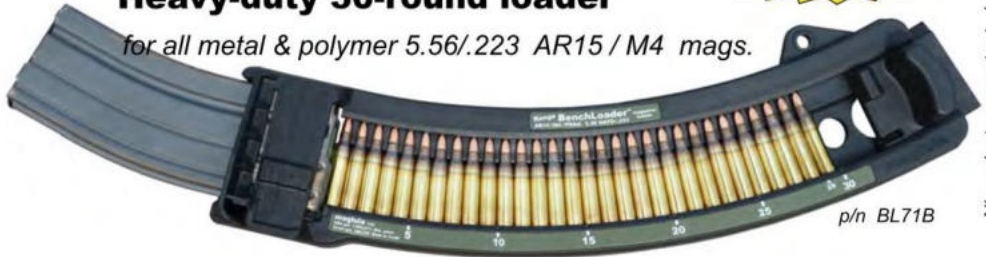

p/n BL71B

All products are patented and trademarked, owned by maglula Ltd., Israel

World's #1 magazine loaders !

maglula Ltd.

Range

MSRP \$149

BenchLoader™

Heavy-duty 30-round loader

for all metal & polymer 5.56/.223 AR15 / M4 mags.
p/n BL71B

Now available!

SIG MPX™

9mm LULA™ magazine loader & unloader
p/n LU19B



New

UpLULA™ colors - Purple, Lemon, Green, OrangeBrn



p/n UP60PR



p/n UP60L



p/n UP60DG



p/n UP60BO

U.S. Pat. 7,059,077; Design Pat. D728,065 BenchLoader is a trademark of maglula Ltd.

MPX is a trademark of SigSauer.

World's #1 loaders !

maglula Ltd.

May 2017

CZ Scorpion™

9mm **LULA** magazine loader & unloader
p/n LU17B

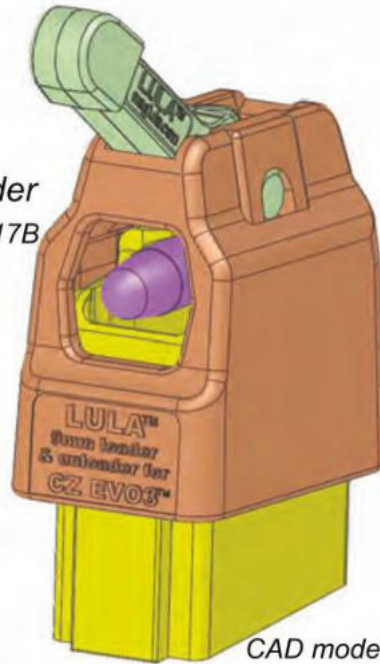

Now available!

SIG MPX™

9mm **LULA™** magazine loader & unloader
p/n LU19B



Now available!

New **UpLULA™** colors - Purple, Lemon, Green, OrangeBrn



p/n UP60PR



p/n UP60L



p/n UP60DG



p/n UP60BO

LULA & UpLULA are trademarks of maglula Ltd.

MPX is a trademark of SigSauer. Scorpion is a trademark of CZ Inc.

World's #1 loaders !

maglula Ltd.

July 2017



CAD model

AR15 7.62x39

LULA™ magazine loader & unloader
p/n LU11B

May 2017

CZ Scorpion™

9mm **LULA™** magazine loader & unloader
p/n LU17B



CAD model

Now available!



SIG MPX™

9mm **LULA™** magazine loader & unloader
p/n LU19B

UpLULA™ colors - Purple, Lemon, Green, OrangeBrn



p/n UP60PR



p/n UP60L



p/n UP60DG



p/n UP60BO

LULA & UpLULA are a trademarks of maglula Ltd.

Scorpion is a trademark of CZ Inc. MPX is a trademark of SigSauer.

World's #1 loaders !

maglula Ltd.



CAD model

Dec. 2017

AR15 7.62x39

LULA™ magazine loader & unloader
p/n LU11B

Available now!

CZ Scorpion EVO3™

9mm **LULA™** magazine loader & unloader
p/n LU17B



Available now!



SIG MPX™

9mm **LULA™** magazine loader & unloader
p/n LU19B

UpLULA™ colors - Purple, Lemon, Green, OrangeBrn



p/n UP60PR



p/n UP60L



p/n UP60DG



p/n UP60BO

LULA & UpLULA are a trademarks of maglula Ltd.
Scorpion EVO3 is a trademark of CZ Inc.
MPX is a trademark of SigSauer.

World's #1 loaders !

maglula Ltd.

AR15 LULA®

5.56 / .223 loader & unloader

New!
Gen. II

After 17 years
of production -
Now compact,
easier,
lighter



p/n LU10B

UpLULA™

9mm to .45ACP universal
pistol mag loader

16,000
5-star reviews
online!



p/n UP60B



Available in six colors

All products are patented and trademarked by maglula Ltd., Israel

**World's best selling
magazine loaders !**

Over thirty professional pistol & rifle
mag loaders - Made in Israel

Ask your local dealer

maglula Ltd.
Since 2001

maglula.com

UpLULA®

9mm - .45ACP universal
pistol magazine loader
& unloader



UP60B

Available colors



- Fits single & double-stack mags
- Painless loading & unloading
- Highly reliable, lightweight
- Works like a champ, for years !

AR15 LULA®

5.56 / .223 loader & unloader



LU10DG

**World's best selling
magazine loaders !**

Over thirty professional pistol & rifle
mag loaders - Made in Israel

Ask your local dealer

maglula Ltd.
Since 2001

maglula.com

AR15 LULA[®]

5.56 / .223 mag loader & unloader

New!
DarkGreen



p/n LU10DG



No more pain![™]

UpLULA[®]

9mm - .45ACP universal
pistol magazine loader



p/n UP60B

World's
#1
Loaders!

Available colors
● ● ● ● ●

Range BenchLoader[®]

Heavy-duty 30-round loader
5.56 / .223 AR15 / M4 mags



p/n BL71B

World's #1 selection of magazine loaders !

Professional pistol & rifle mag loaders

Ask your distributor

maglula Ltd.

maglula.com

U.S. Patented LULA and BenchLoader are registered trademarks of maglula Ltd.

BIDEN NOMINATES NEW AMC BOSS ★ CAUSE OF F-22 MISHAP REVEALED

AirForceTimes

PROUD TO SERVE THOSE WHO SERVE™



SERVICE MEMBERS of the YEAR

UNDER FIRE AT TINKER



A CO LAMBASTS CANCELED SORTIES. IS IT TOXIC LEADERSHIP?

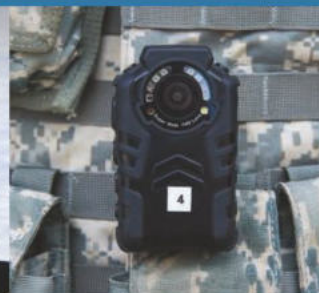

BODY CAMS GO BYE-BYE

SECURITY FORCES TOLD TO GET RID OF DEVICES

PROMO TESTS TO GO ONLINE

A NEW MANUAL FOR MOMS-TO-BE

AUGUST 2021
VOL. NO. 82 ISSUE NO. 8
NOT A US AIR FORCE PUBLICATION

\$3.99



MADE FOR THOSE WHO LOVE THEIR STUFF

USAA RENTERS INSURANCE
Visit usaa.com/renters

Membership eligibility and product restrictions apply and are subject to change. Renters insurance provided by United Services Automobile Association, USAA Casualty Insurance Company, USAA General Indemnity Company, Garrison Property and Casualty Insurance Company, based in San Antonio, TX, USAA Limited (UK) and USAA S.A. (Europe), and is available only to persons eligible for PNC group membership. Each company has sole financial responsibility for its own products. © 2021 USAA, 275451-0521



WHAT YOU'RE MADE OF WE'RE MADE FOR™

AR15/M4
StripLULA®
 5.56 10rd stripper-clip mag loader



SL50B - NSN 1005310167299

UpLULA®
 9mm - .45ACP universal
 pistol mag loader
 & unloader



UP60B - NSN 1005310172705

AR15/M4
BenchLoader®
 5.56 heavy-duty
 30rd mag loader



BL71B - NSN 1005310173431

GSA Advantage!

**World's best selling
 magazine loaders !**

Over thirty professional pistol & rifle
 mag loaders - Made in Israel

maglula Ltd.
 Since 2001

EX-AIR FORCE E-7 GETS PRISON IN DRUGS, GUNS CASE

A former Air Force master sergeant assigned to Nellis Air Force Base has been sentenced to 32 months in prison after pleading guilty to drug and weapons charges. He had faced the possibility of life in prison.

The U.S. Attorney's Office for Nevada said former Master Sgt. Michael Reimers, 41, of Las Vegas was sentenced July 13 after pleading guilty in April to one count each of distribution of a controlled substance and engaging in the business of dealing in firearms without a license.

A military judge found Reimers guilty in a general court-martial on March 11. His sentence: 84 months of confinement, a six-grade demotion from master sergeant to airman basic, and a dishonorable discharge.

According to prosecutors, Reimers in 2019 sold



large quantities of methamphetamine and cocaine to various buyers and also sold an AK-47 assault rifle, a handgun and a shotgun to the same buyers. He was arrested that same year.

The office said the case was investigated by the federal Drug Enforcement Administration and the Las Vegas Metro and Henderson police departments.

AIR RESERVE TEST PILOT KILLED IN TRAFFIC ACCIDENT

An Air Force Reserve test pilot, who had served 16 years in the Marine Corps, died at about 7:50 p.m. July 5 in a traffic accident near Panamint Valley, California, according to a July 8 news release from Edwards Air Force Base.

Maj. Aaron "Amber" Frey, 42, from Evergreen, Colorado, was assigned to the 370th Flight Test Squadron at Edwards. He also served as an F-16 test pilot instructor for the Air Force Test Pilot School and an F-35 test pilot for the 461st Flight Test Squadron at Edwards.

Frey joined the Marine Corps in 2004, and deployed to Afghanistan twice during his 16 years in the Corps, according to a GoFundMe page established for his family. While still a Marine he graduated from the Air

Force Test Pilot School and was assigned to the 461st FLTS. He joined the Air Force Reserve about a year ago.

"Amber was a loving husband, father of 2 kiddos, a wingman, friend, warrior, and talented Airmen," his GoFundMe page said.

"He was the happiest person around and made everyone's life brighter." Edwards Air Force Base officials said in a statement. "He had the most recognizable radio voice that brought smiles to all who heard him talk on the radio."

The California Highway Patrol is investigating the accident. A memorial service was planned for July 16 at Edwards.



FROM TOP: AIR FORCE; BRAD WHITE/AIR FORCE

ONE HUNDRED MISSING NVGS ★ NEW 'BLACK HAWK DOWN' AWARDS

ArmyTimes

PROUD TO SERVE THOSE WHO SERVE™



NCO OVERHAUL

WHY YOUR NEXT PROMOTION MAY TAKE LONGER



NO MORE TAPE TEST?
ARMY TO STUDY BODY FAT PROGRAM

WARRANTS WANTED

VEHICLE MISHAPS PROBED

AUGUST 2021
VOL. NO. 82 ISSUE NO. 8
NOT A US ARMY PUBLICATION

\$3.99



MADE FOR THOSE WHO LOVE THEIR STUFF

USAA RENTERS INSURANCE
Visit usaa.com/renters



WHAT YOU'RE MADE OF WE'RE MADE FOR™

Membership eligibility and product restrictions apply and are subject to change. Renters insurance provided by United Services Automobile Association, USAA Casualty Insurance Company, USAA General Indemnity Company, Garrison Property and Casualty Insurance Company, based in San Antonio, TX, USAA Limited (UK) and USAA S.A. (Europe), and is available only to persons eligible for FIC group membership. Each company has sole financial responsibility for its own products. © 2021 USAA, 278451-0521

AR15/M4
StripLULA®
5.56 10rd stripper-clip mag loader



SL50B - NSN 1005310167299

UpLULA®
9mm - .45ACP universal
pistol mag loader
& unloader



UP60B - NSN 1005310172705

AR15/M4
BenchLoader®
5.56 heavy-duty
30rd mag loader



BL71B - NSN 1005310173431

GSA Advantage!

**World's best selling
magazine loaders !**

Over thirty professional pistol & rifle
mag loaders - Made in Israel

maglula Ltd.
Since 2001

MARINE GUNNY BUSTED TO PRIVATE BUT NO DISCHARGE IN GREEN BERET HAZING DEATH

A Marine Raider was found guilty July 2 of involuntary manslaughter in the 2017 hazing death of a Green Beret in Mali.

Gunnery Sgt. Mario Madera-Rodriguez was found guilty of hazing, making false official statements, conspiracy and involuntary manslaughter — but not guilty of felony murder.

His punishment included a reprimand, reduction in paygrade to E-1 and confinement for six months. Unlike the other three service members involved in the incident, Madera-Rodriguez will receive no bad conduct nor dishonorable discharge. Madera-Rodriguez was the

final co-defendant to be sentenced for the strangulation death of Army Staff Sgt. Logan Melgar.

On June 4, 2017, Melgar had been in his bedroom in off-site housing in Bamako, Mali, when the four service members broke through with a sledgehammer.

Melgar woke up, however, so two Navy SEALs and two Marines placed him in a chokehold. That's when Melgar stopped breathing.

They stopped the attack and began lifesaving procedures, including a field-expedient tracheotomy. They later took Melgar to a medical clinic where he was pronounced dead.



NO MORE TAPE TEST? ARMY STUDY TO REEVALUATE BODY FAT PROGRAM

The Army will formally study the body compositions of more than 2,000 soldiers beginning in October, and the service plans to use the data it gathers to determine the future of its body composition program, physical fitness manuals and the much-maligned "tape test."

The Army's Center for Initial Military Training will lead the study in conjunction with the Army Research Institute of Environmental Medicine, according to an Army Headquarters execute order.

The study will take place at Fort Bragg, North Carolina, the order says. The study's goal is to provide senior leaders with "information with regards to...taping of soldiers, body fat, and body changes, and considerations of the relationship between body fat and fitness levels," the order reads.

The study will also evaluate alternative methods of calculating body fat. The current method of determining body fat compliance across the force is the tape test, which utilizes mathematical formulas to calculate a soldier's body fat based on the measured circumference of key areas of their body.

Critics have long argued that the tape test can overestimate body fat for soldiers with a high level of physical fitness.

Approximately 2,000 active-duty troops from Fort Bragg, North Carolina, will participate in the two-week study, the order says.

The findings will be presented to Army senior leaders in March 2022, the order says. From there, Army leadership will determine whether to make changes to the Army's body composition program.



FROM TOP: ARMY; CAPT. FERNANDO OCHOA/ARMY

FEMALE DRILL INSTRUCTORS NEEDED ★ NEW GRENADE-LAUNCHED DRONES



MARINE CORPS **MarineTimes**

PROUD TO SERVE THOSE WHO SERVE™



LAST MAN STANDING MARINE CORPS FOLDING ITS LONGTIME WRESTLING TEAM



PROMOTION BOARD PHOTOS

THEY MAY BE COMING BACK. HERE'S WHY

A RARE LOOK INTO VEHICLE MISHAPS

PCS NIGHTMARES FOR MILITARY FAMILIES

AUGUST 2021
VOL. NO. 23 ISSUE NO. 8
NOT A USMC PUBLICATION

\$3.99



**MADE FOR THOSE WHO
LOVE THEIR STUFF**

USAA RENTERS INSURANCE
Visit usaa.com/renters



**WHAT YOU'RE MADE OF
WE'RE MADE FOR™**

Membership eligibility and product restrictions apply and are subject to change. Renters insurance provided by United Services Automobile Association, USAA Casualty Insurance Company, USAA General Indemnity Company, Gurnison Property and Casualty Insurance Company, based in San Antonio, TX, USAA Limited (UK) and USAA S.A. (Europe), and is available only to persons eligible for PSC group membership. Each company has sole financial responsibility for its own products. © 2021 USAA. 275831-0221

AR15/M4
StripLULA®
 5.56 10rd stripper-clip mag loader



SL50B - NSN 1005310167299

UpLULA®
 9mm - .45ACP universal
 pistol mag loader
 & unloader



UP60B - NSN 1005310172705

AR15/M4
BenchLoader®
 5.56 heavy-duty
 30rd mag loader



BL71B - NSN 1005310173431

**World's best selling
 magazine loaders !**
 Over thirty professional pistol & rifle
 mag loaders - Made in Israel
maglula Ltd.
 Since 2001



POOLEE DIES AFTER 400M RUN

A 26-year-old Michigan poolee died July 10, only two days after formally enlisting into the delayed entry program, a Marine Corps spokesman said.

Justin Grihorash collapsed during a 400 meter run that was part of a physical training event organized by the Capital City recruiting substation based in Lansing, Michigan, a Naval Safety Center report said. After collapsing, CPR was performed on Grihorash, the report said. He later died in a hospital.

An obituary read, "He was a kind compassionate man who would do anything for anyone. His love and generosity were non stop and his loving personality would light up the room."

An investigation into his death is ongoing.

JOB QUALIFICATIONS COMING TO JUNIOR ENLISTED EVALUATION SYSTEM

The Marine Corps is updating the junior enlisted performance evaluation system to better account for job proficiency, according to a recently released message.

The pilot program, first launched for 51 military occupational specialties in the enlisted aviation field, is scheduled to start in late July and will see MOS-related courses and qualifications count toward 100 points or 50 percent of the mental agility pillar.

For the aviation field, that means Marines who become collateral duty inspectors will receive 30 points, while collateral duty quality assurance representatives and quality assurance safety observers will receive 40 points.

Marines are both collateral duty inspectors and quality assurance safety observers will receive 70 points,

while Marines who are both collateral duty quality assurance representatives and quality assurance safety observers will earn 80 points.

A similar program will be launched for every other enlisted MOS over the next year, once each field has a "codified a list of courses and qualifications."

"Marines in the selected MOSs identified in the MarAdmin can complete the courses and/or obtain the qualifications based on requirements in the MOS manual," said Marine spokesman Maj. Jordan Cochran.

The junior enlisted performance evaluation system, or JEPES, was launched on Feb. 1, 2021, replacing the old promotion system for sergeants and corporals that was based around proficiency and conduct marks.



DIGNITY MEMORIAL OBITUARY: CPL. TAWANYA NORWOOD/MARINE CORPS

SPECIAL LEAVE ACCRUAL EXPANDED ★ NEW NATO COMMAND IN NORFOLK



SERVICE MEMBERS
of the YEAR

NavyTimes

PROUD TO SERVE THOSE WHO SERVE™



BONHOMME RICHARD FIRE
SAILOR CHARGED WITH SETTING SHIP ABLAZE

IKE COMPLETES A DOUBLE PUMP

PROMO BOARDS MAY GET PICS

AUGUST 2021
VOL. NO. 71 ISSUE NO. 8
NOT A US NAVY PUBLICATION

FRICITION ON THE BLACK SEA

SAILORS GET AN UP-CLOSE LOOK AT GREAT POWER COMPETITION

\$3.99



MADE FOR THOSE WHO LOVE THEIR STUFF

USAA RENTERS INSURANCE
Visit usaa.com/renters



WHAT YOU'RE MADE OF WE'RE MADE FOR™

Membership eligibility and product restrictions apply and are subject to change. Renters insurance provided by United Services Automobile Association, USAA Casualty Insurance Company, USAA General Indemnity Company, Garmon Property and Casualty Insurance Company, based in San Antonio, TX, USAA Limited (UK) and USAA S.A. (Europe), and is available only to persons eligible for PNC group membership. Each company has sole financial responsibility for its own products. © 2021 USAA, 21845-0521

AR15/M4
StripLULA®
5.56 10rd stripper-clip mag loader



SL50B - NSN 1005310167299

UpLULA®
9mm - .45ACP universal
pistol mag loader
& unloader



UP60B - NSN 1005310172705

AR15/M4
BenchLoader®
5.56 heavy-duty
30rd mag loader



BL71B - NSN 1005310173431

GSA Advantage!

World's best selling magazine loaders!

Over thirty professional pistol & rifle mag loaders - Made in Israel

maglula Ltd.
Since 2001

SPECIAL LEAVE ACCRUAL EXPANDED FOR ALL SAILORS

Sailors haven't had ample opportunities this fiscal year to use up their leave due to the COVID-19 pandemic, according to Navy leaders.

That's why the service is expanding its special leave accrual policy for all sailors — regardless of duty station, according to a NAVADMIN released July 28.

While sailors have been permitted to carry up to 120 days of leave under a 2020 Pentagon special leave accrual policy, the Navy's updated guidance makes several key changes. First, it extends the amount of time sailors may carry over a leave balance greater than 60 days by an additional year, from September 2023 to September 2024.

Secondly, it means leave accrued during all of fiscal 2021 will go toward a sailor's special leave accrual balance, according to Chief of Naval Personnel Vice



Adm. John Nowell Jr.

"What we do in the Navy is hard on a normal day," Nowell told reporters. "And then when you look at COVID, we know that it's important for folks to have a chance to take some time off."

Nowell admitted it isn't always easy to take leave, but urged sailors to take time off to "rest and recharge."

Under the Pentagon policy unveiled in April 2020, service members could acquire up to 120 days between March 11, 2020, and Sept. 30, 2020. They could then use that leave through Sept. 30, 2023.

But fiscal year 2021 didn't present dramatically different circumstances for sailors, according to Fleet Master Chief Wes Koshoffer. That's why the Navy wanted to give sailors an additional opportunity to take time off.

MUSTIN JOINS 3RD FLEET AFTER 15 YEARS IN JAPAN

The guided-missile destroyer Mustin is in San Diego, California, to join the 3rd Fleet after departing Yokosuka, Japan, in June.

The Mustin, originally commissioned in San Diego in 2003, has spent 15 years assigned to Destroyer Squadron 15 in Yokosuka as part of the Forward Deployed Naval Forces.

The destroyer was involved in several major humanitarian efforts while based in Japan. Those efforts included assisting Myanmar, with the Essex Amphibious Ready Group, following Cyclone Nargis in 2008, and responding to the 9.0 magnitude Tohoku earthquake and subsequent tsunami that struck Japan in 2011.

More recently, the ship has continued to complete training exercises and operations, despite the COVID-19 pandemic, including Integrated Ship and Air Team Training and Surface Warfare Advanced Tactical Training.

The ship also participated in dual carrier operations as part of the Reagan Carrier Strike Group, and completed freedom of navigation operations.

The ship is now set to undergo a planned two-year depot modernization period.

"Planned maintenance availabilities like these are critical to ensuring ships are maintained and equipped to perform combat-ready tasking when called upon and achieve their expected service life," Cmdr. Robert Briggs, the Mustin's commanding officer, said in a news release.

The Mustin arrived in San Diego July 22. The guided-missile destroyer Ralph Johnson, currently based in Everett, Washington, will replace the Mustin in Japan, the Navy said.



LCS INDEPENDENCE IS DECOMMISSIONED

The LCS Independence was decommissioned July 29 in San Diego — leaving the fleet with 22 littoral combat ships.

The Independence, which was commissioned in 2010, was one of the test and training vessels for the littoral combat ship program, along with the Freedom, Fort Worth and Coronado.

In February 2020, then-Rear Adm. Randy Crites, the deputy assistant secretary of the Navy for budget at the time, said the early versions of the littoral combat ship needed major, expensive upgrades, and it was better for them to be mothballed.

During the decommissioning event, Vice Adm. Roy Kitchener, commander of Naval Surface Force, U.S. Pacific Fleet, praised the ship and its crew for their contributions during the ship's 11 years in service.

"The Independence crew shouldered a heavy responsibility," Kitchener said. "Since the ship's introduction into the fleet, we asked her to serve for a specific purpose: to test emerging equipment and concepts.

"The crew accomplished that and so much more."

MC2 JACOB MELHAM/NAVY; MC1 JASON ABBAS/NAVY

WILL RUSSIA INVADE UKRAINE? ★ A-10 PILOT'S HEROISM BRINGS DFC

AirForceTimes

PROUD TO SERVE THOSE WHO SERVE™



**UFO SIGHTING?
DoD WILL NOW
PROBE IT**



WEAK LINK?
REPORT SAYS USAF
REFUELING CAPACITY
IS NOW 'TOO BRITTLE'

**HERE'S HOW THE
NEW PT TEST
WILL BE SCORED**

**SECDEF
SQUASHES
STATE GUARD'S
VAX OPT-OUT**

DECEMBER 2021
VOL. NO. 82 ISSUE NO. 12
NOT A US AIR FORCE PUBLICATION



PARTNERS IN PERIL

U.S.-TRAINED AFGHAN PILOTS WONDER WHAT'S NEXT

\$3.99



Don't settle for basic.
usaa.com/auto



AUTO
INSURANCE

Membership eligibility and product restrictions apply and are subject to change. Auto insurance provided by United Services Automobile Association and its property and casualty affiliates, San Antonio, Texas. No Department of Defense or government agency endorsement. © 2021 USAA. 280418-0721

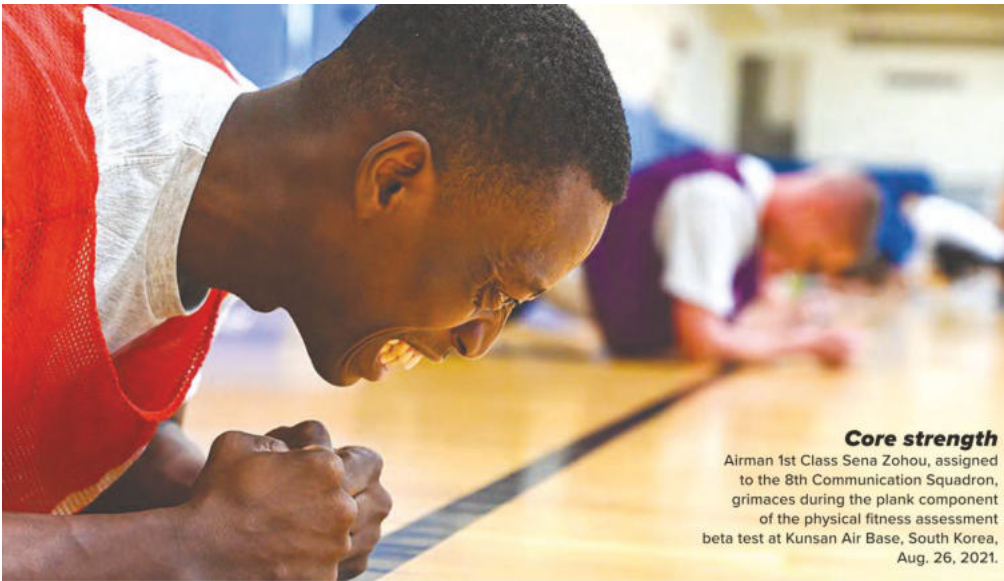

Core strength

Airman 1st Class Sena Zohou, assigned to the 8th Communication Squadron, grimaces during the plank component of the physical fitness assessment beta test at Kunsan Air Base, South Korea, Aug. 26, 2021.

THE SCORES YOU NEED TO PASS THE NEW PT TEST

By Rachel S. Cohen
rcohen@militarytimes.com

Lace up those sneakers: The new PT tests are coming. The Air Force on Nov. 12 released a fresh set of spreadsheets that will be used to calculate airmen's scores on the revamped annual physical fitness assessment, which begins in January. It solidifies the service's shift to a test that offers more exercise options for troops, aiming to personalize PT testing without losing its rigor. Those options include a 1.5-mile run or 20-meter shuttle run for cardiovascular fitness, traditional or hand-release push-ups for upper body strength, and traditional sit-ups, cross-legged reverse crunches or planks for core strength. "While testing these components at various installations, we received a large amount of positive feedback," said Lt. Gen. Brian Kelly, Air Force deputy chief of staff for manpower, personnel and services, in a news release. "Changes to the physical fitness assessments reflect what we learned and our desire to provide airmen with additional flexibility in maintaining fitness standards." No longer on the list is a one-mile speed walk that was explored as a new addition. That decision was based on "equipment requirements and the need for continued testing," the Air Force said. Going forward, men and women's scores will be split into nine age groups: under 25, 25-29, 30-34, 35-39, 40-44, 45-49, 50-54, 55-59 and over 60. Airmen can score up to 60 points on the cardio portion, 20 points on the upper body portion and 20 on the core portion. Some categories are judged on time, while others are judged on repetitions. For example, to nab the highest

cardio score, a 22-year-old man can either run 1.5 miles in under 9 minutes and 12 seconds, or complete at least 100 laps back and forth in the shuttle run. The minimum amount of exercise that airmen must finish varies by age and gender. Men younger than 25 must complete 1.5 miles within 15 minutes and 50 seconds. They also need to notch at least 36 shuttles, 30 regular push-ups, 15 modified push-ups, 39 sit-ups, 21 reverse crunches or a forearm plank lasting at least 1 minute and five seconds. Women under 25 must complete 1.5 miles within 18 minutes and 56 seconds. They're also required to log at least 22 shuttles, 15 push-ups, six modified push-ups, 35 sit-ups, 11 reverse crunches and a plank lasting at least 55 seconds. The scoring chart also breaks down how fast or how many reps someone must run to be deemed at low, moderate or high risk for cardiovascular disease, diabetes, cancer and other health problems. Starting Dec. 10, airmen can schedule their PT tests and pick the cardio option they want on the myFitness system. They can choose which strength components to test when they come in that day. Waist measurement no longer counts toward a person's PT test score, but the military still requires airmen to maintain weight standards and be measured for healthy body composition. "The Air Force Surgeon General, who has responsibility for overall airmen health, has reviewed alternatives and determined waist-to-height ratio as the best available method for assessing body composition," the service said. More guidance will roll out in the coming months. Though the Space Force falls under the Department of the Air Force, it won't adopt the PT changes as it designs its own health assessment in 2022.

TECH. SGT. JAMES CASON/AIR FORCE

AR15/M4
StripLULA®
5.56 10rd stripper-clip mag loader



SL50B - NSN 1005310167299

UpLULA®
9mm - .45ACP universal
pistol mag loader
& unloader



UP60B - NSN 1005310172705

AR15/M4
BenchLoader®
5.56 heavy-duty
30rd mag loader



BL71B - NSN 1005310173431

GSA Advantage!

World's best selling magazine loaders!
Over thirty professional pistol & rifle mag loaders - Made in Israel
maglula Ltd.
Since 2001

NIGER AMBUSH VIDEO RECOVERED ★ FIRST WOMAN COMPLETES SNIPER COURSE

ArmyTimes

PROUD TO SERVE THOSE WHO SERVE™



**UFO SIGHTING?
DoD WILL NOW
PROBE IT**



**NO COVID VAX?
ARMY ISSUES UPDATED
REGULATIONS FOR YOU**

**RECRUITERS GET
INDIVIDUAL QUOTAS**

**JUNIOR ENLISTED
COULD LOSE EMAIL**

DECEMBER 2021
VOL. NO. 82 ISSUE NO. 12
NOT A US ARMY PUBLICATION

ALASKA HEATS UP INSIDE EARLY PLANS FOR AN ARCTIC BRIGADE



\$3.99



Don't settle for basic.
usaa.com/auto



AUTO
INSURANCE

Membership eligibility and product restrictions apply and are subject to change. Auto insurance provided by United Services Automobile Association and its property and casualty affiliates, San Antonio, Texas. No Department of Defense or government agency endorsement. © 2021 USAA. 280418-0721



Welcome to the team

The 1st Cavalry Division held a patch ceremony for approximately 66 troopers arriving to the unit, Nov. 3, 2021, at Fort Hood, Texas.

WILL 'RECEPTION COMPANIES' HELP THE ARMY'S PCS WOES? SMA THINKS SO

By Davis Winkie
davis.winkie@militarytimes.com

It's been a rough few years for Army troops executing permanent change of station moves.

Waitlists for housing, moving company shortages, and more have bedeviled soldiers — as has the uneven quality of the Army's "sponsorship" program, which is intended to pair moving soldiers with mentors in their new units.

Those issues drove the service to create new "reception companies," which will be small units at major installations dedicated to helping new soldiers navigate their arrival and in-processing, explained Army senior leaders in a media roundtable in October.

The Army will create 13 of the units, which will vary in size based on the installation's size, by fiscal 2025, Sergeant Major of the Army Michael Grinston said. The Army's top NCO emphasized the importance of helping soldiers at transition points in their career.

"The transitions are hard," Grinston said. "[Nearly] every one of the quality of life initiatives deal with, mostly, a transition...I think reception companies help us receive people in our organization."

While the first officially-authorized units won't arrive until October 2022, some units across the Army have decided to implement an interim version of the program.

The 1st Cavalry Division at Fort Hood, Texas, inaugurated its reception company on Nov. 3 in a ceremony where the company's first new soldiers were handed off to their units.

One of the division's senior-most operations NCOs told Army Times in a phone interview that the new in-processing experience at "Pegasus Troop" is radically different from what he experienced.

"The in-processing that I went through, it wasn't [very] helpful," said Sgt. Maj. Kenneth Dyer, who helped plan the interim unit. "Here's a sheet. Here's some things that you need to do." And that [was] it."

Now there's a structured program of instruction meant to show new soldiers what's going on, where important things are happening and how their lives will work at Fort Hood.

"It allows troopers time to get themselves and their family situated," Dyer added. "It takes time to find a home and

to find childcare in each PCS [move]. ... This program, it provides guidance and time, which allows our new team members [to] navigate those situations before they have to report to their unit and get into it."

The reception company's top NCO, Sgt. 1st Class Brian Brown, explained that the eight-day reception period offers an opportunity to knock out much of the Army's required annual training and readiness items up front and resolve any lingering PCS or pay issues.

"We'll get them integrated as far as equal opportunity classes, [sexual assault and harassment prevention] classes... resiliency training, and any pay issues they have," Brown said in a phone interview. "When they ship out to their unit ... they're ready on day one."

The process allows new soldiers to focus on integrating into day-to-day life and operations rather than getting caught up on mandatory trainings.

"We're here to get them squared away and ready to get to the fight," said Dyer.

The program also includes a meeting with the division commander and senior enlisted leader, in addition to classes on the division's history and heritage. One new soldier who went through the company said the experience has left him confident in his new unit, too.

"It's truly welcoming," said Pvt. Dallas Aistrup, an infantry soldier who recently graduated from training at Fort Benning, Georgia. "First impressions are a big thing."

The Army's top enlisted soldier, Grinston, says the permanent reception companies will be even better than these interim efforts.

The service plans to structure positions in the units as prestigious slots available to only the most-qualified soldiers who have completed their key assignment in their current rank. The positions won't be linked to any specific military occupational specialty or officer area of concentration, Grinston added, explaining that it's more important to have the right soldier for the job.

"We're looking to say there [will] be a second-time first sergeant or a second-time commander," Grinston said, adding that the goal is to "get a quality [leader] that says, 'Here, welcome to my organization, let me tell you what's great about here.'"

PFIC CHEYNE HANOSKI/ARMY

AR15/M4
StripLULA®
5.56 10rd stripper-clip mag loader



SL50B - NSN 1005310167299

UpLULA®
9mm - .45ACP universal
pistol mag loader
& unloader



UP60B - NSN 1005310172705

AR15/M4
BenchLoader®
5.56 heavy-duty
30rd mag loader



BL71B - NSN 1005310173431

GSA Advantage!

World's best selling magazine loaders!

Over thirty professional pistol & rifle mag loaders - Made in Israel

maglula Ltd.
Since 2001

SEXUAL ASSAULT INVESTIGATIONS FAILING ★ WHY MEUs COULD TAKE A HIT

CORPS MarineTimes

PROUD TO SERVE THOSE WHO SERVE™



**UFO SIGHTING?
DoD WILL NOW
PROBE IT**

'HUMANS, NOT INVENTORY'

THE CORPS' PLAN TO FIND AND KEEP THE BEST MARINES



**VACCINATION
DEADLINE**
5% OF ACTIVE DUTY
MARINES MAY GET
THE BOOT

**WHY IT WILL BE
HARDER TO GET
RECRUITED**

**PONYTAILS FOR
FEMALE MARINES?**

DECEMBER 2021
VOL. NO. 23 ISSUE NO. 12
NOT A USMC PUBLICATION

\$3.99



Don't settle for basic.
usaa.com/auto



Membership eligibility and product restrictions apply and are subject to change. Auto insurance provided by United Services Automobile Association and its property and casualty affiliates, San Antonio, Texas. No Department of Defense or government agency endorsement. © 2021 USAA. 280418-0721



WHY MARINE EXPEDITIONARY UNITS COULD SOON TAKE A HIT

Shrinking the Corps
The Marine Expeditionary Unit may suffer under new Marine Corps plans, one expert says.

By Todd South
tsouth@militarytimes.com

The Marine Corps is getting smaller, that's no secret.

But a recently released report diving into the Corps' budget shows exactly which areas will be shrinking and how that might stretch demands on the force.

The Center for Strategic and International Studies published its "U.S. Military Forces in FY 2022: Marine Corps" on Nov. 17. It reflects much of what has been acknowledged publicly since the start of Commandant Gen. David Berger's tenure in 2019. The Corps has to shift to fight alongside the Navy to be relevant in a great power competition with the Russian and Chinese military, but mostly the Chinese.

That has meant shedding assets and personnel such as tanks and police while beefing up fires from conventional artillery to longer-range rockets. It's also meant an overhaul of infantry training.

What's gotten less attention is Berger's aims to streamline aviation, taking a hard look at F-35 acquisition and finally getting the service into the drone game at scale. That means more drone pilots and drones to fight at longer ranges.

And those specially trained and experienced infantry? By Marine vet and CSIS report author Mark Cancian's estimation, they're going to be spread thin, meaning some of the bread-and-butter work that the Marines have used as a calling card since the Cold War ended — the Marine Expeditionary Units — may suffer.

Cancian notes that flat budget top lines heading into 2022 and beyond have forced Berger to pick equipment instead

of people, or at least numbers of people.

The Corps is on a path to shrink the force down to 172,000, the level it was before 9/11. In 2020, the Corps was slightly more than 180,000 active duty Marines and nearly 40,000 reservists.

Some cuts will come wholesale in unit deactivations. It only will have 22 infantry battalions versus 24 now on paper. The plan is to fully staff those battalions. But the grunts aren't paying all the dues. The top Marine is reviewing up to 15% personnel cuts in headquarters and supporting establishments, Cancian wrote.

Berger hasn't hidden his hard look at aviation, though details have been sparse.

"I am not convinced that we have a clear understanding yet of F-35 capacity requirements for the future force," Cancian quotes from Berger's 2020 posture statement remarks to Congress.

Eventually, Berger wants half of his aviation fleet unmanned, he said in March.

For now, he also has detailed in his Force Design 2030 report that he wants six active component unmanned vehicle squadrons for the future force.

That's double the availability now.

But Marines piloting those existing drones have limited options.

The Corps only has two armed drones as compared to the Air Forces' 351. The Corps did shift away from its large-scale plan to build a drone that would do everything: the Marine Air-Ground Task Force Unmanned Aerial System Expeditionary, or MUX.

The high price tag had some in Congress balking. Instead, the Corps has shifted to the MQ-9 Reaper drone as its entry point to higher-level drones.

The MQ-9 plan, thus far, hasn't been

fully ironed out, Cancian points to documents suggesting a "loyal wingman" approach, like the Air Force's method of using drones of that caliber.

The additional three squadrons would be stood up by 2026, documents said.

What might affect more Marines and what they do when deployed is the creation of the Marine littoral regiments: the Corps' current answer for how to be fighting at scale with China.

There are three planned in total, they'll be heavy on fires and lighter on infantry but will still need grunts on the ground.

That will draw forces from the MEUs, Cancian argues. And the Marine littoral regiments can't really be used the way MEUs are today, he writes.

"The full MLR is too large for routine long-term deployments, deploying just the combat team would leave the rest of the unit incomplete, and deploying a proportional slice would not produce the wide variety of capabilities that forward-deployed Marine units have traditionally had. Instead, the Marine Corps may move to periodic but limited-duration deployments for exercises and engagements with allies and partners."

That's especially true if the Corps wants to keep running seven MEUs across the globe with all associated personnel and gear, Cancian wrote.

An option is a tool that the Corps has used increasingly in the past decade: the Special Purpose Marine Air-Ground Task Force.

As one of the few deployable units smaller than a MEU, it can be designed for unique tasks, but that size difference comes "at the cost of logistics and firepower," Cancian notes.

AR15/M4
StripLULA®
5.56 10rd stripper-clip mag loader



SL50B - NSN 1005310167299

UpLULA®
9mm - .45ACP universal
pistol mag loader
& unloader



UP60B - NSN 1005310172705

AR15/M4
BenchLoader®
5.56 heavy-duty
30rd mag loader



BL71B - NSN 1005310173431

GSA Advantage!

**World's best selling
magazine loaders !**

Over thirty professional pistol & rifle
mag loaders - Made in Israel

maglula Ltd.
Since 2001

CPL CHRISTIAN AYERS/MARINE CORPS

WILL RUSSIA INVADE UKRAINE? ★ CHINA'S MOCK-UPS OF U.S. WARSHIPS

NavyTimes

PROUD TO SERVE THOSE WHO SERVE™



**UFO SIGHTING?
DoD WILL NOW
PROBE IT**

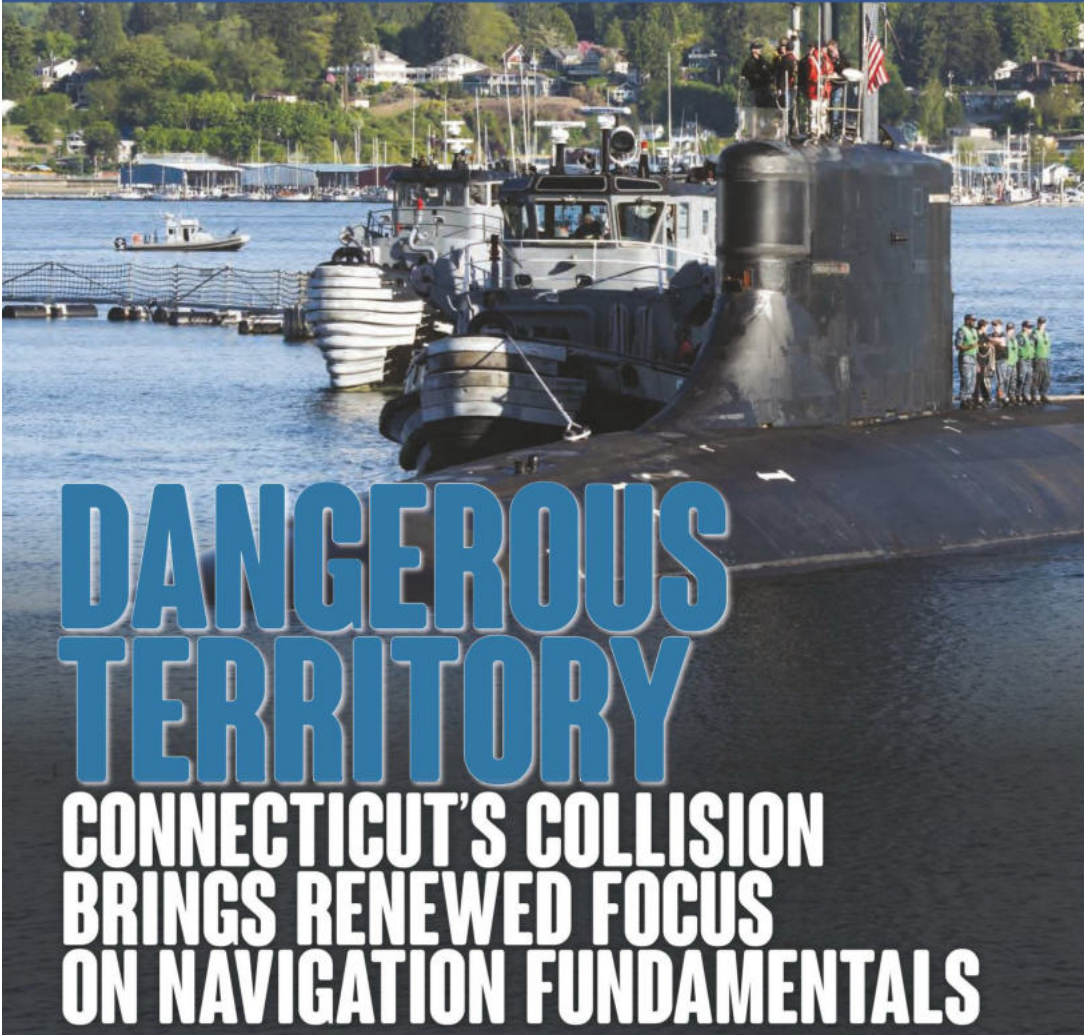

DANGEROUS TERRITORY

CONNECTICUT'S COLLISION BRINGS RENEWED FOCUS ON NAVIGATION FUNDAMENTALS



**MAINTENANCE
REVOLUTION**
NEW SIM TOOLS ARE
CHANGING THE GAME
FOR SAILORS WHO
KEEP SHIPS RUNNING

**BONHOMME
RICHARD
HEARING
DELAYED**

**NAVY FAMILIES
IN HAWAII SAY
WATER IS TOXIC**

DECEMBER 2021
VOL. NO. 71 ISSUE NO. 12
NOT A US NAVY PUBLICATION

\$3.99



Don't settle for basic.
usaa.com/auto



AUTO
INSURANCE

Membership eligibility and product restrictions apply and are subject to change. Auto insurance provided by United Services Automobile Association and its property and casualty affiliates, San Antonio, Texas. No Department of Defense or government agency endorsement. © 2021 USAA. 280418-0721

to bring everybody to a schoolhouse where we can put real shipboard equipment in and train them on that.' And we've been following that model for decades now."

"Now that we can — through virtual computing — use the real code that we use onboard the ships in training systems at a price point that makes it where we can have multiples, now we can take those from the schoolhouse and move them back to the waterfront areas," he continued. "You don't have to travel to go to the training, you can do the training for a day or an afternoon, it makes it available to shipboard sailors in a way that was never possible, and it allows commanding officers to develop a level of proficiency that just wasn't possible before."

Once the schoolhouse is set up in Dahlgren for new sailors training to serve in a handful of billets related to Aegis Combat System maintenance, the next step will be to establish Aegis VMT trainers in Hampton Roads, Va., and San Diego, SCSTC spokeswoman Kimberly Landsdale said. The Navy has also funded a pilot program that would put a single-computer training system — as opposed to the entire classroom of computers — onto a surface ship to see if it's useful to connect sailors at sea with technical experts ashore for managing particularly tough problems.

The trainer will also expand to include the Ship Self-Defense System and the AN/SQQ-89A(V)15 anti-submarine warfare combat system. Future baselines of the Aegis Combat System will be added later.

Stoner said the technology is necessary to keep up with changes in the combat systems the Navy fields on current and upcoming ship classes.

"As a design strategy, we're going more toward software design that is agnostic of the hardware it rides on," he said. "In the past, a lot of our training has been very hardware centric: find the bad circuit card, find the bad voltage regulator or switch or component."

"The ability to train on finding and fixing software faults doesn't really lend itself to the way we were doing training — so it may not be that you have to replace the circuit card, but maybe you have to go in and you have to restart part of the program, or you have to reset something in the software," Stoner added. "These systems are flexible enough to help us train to that level of detail."

AGEIS VMT

Though the Aegis VMT is still in final development, a handful of sailors are already wringing it out to provide feedback before the April rollout.

In a demonstration of the system for Navy Times, Fire Controlman (Aegis) 1st Class Kirt Palmer walked through a training scenario with three petty officers third class.

In an assignment to diagnose and ultimately replace a broken room alert monitor, Fire Controlman (Aegis) 3rd Class Tyler George first went to the phone to report the pending maintenance work up the chain of command — part of helping the students practice not just the hands-on work but also the end-to-end procedures.

FCA3 Felice Hahn then took over after getting permission to do the work, setting up diagnostic equipment and checking inputs and outputs to determine which component was faulty. Once she found the right component, she went back to the phone to report that.

FCA3 Thomas Wyant took over replacing the room alert module itself — but in an error made for the purpose of the demonstration, he forgot to use an electrostatic discharge

wrist strap the Navy manual requires. When he tried to unscrew the module without putting on the wrist strap first, the scenario stopped and Palmer, the instructor, was alerted about a safety violation.

Palmer said the system's ability to flag not just wrong actions but also safety violations is important: Students might be able to fix the fault, but if they are doing it unsafely, there could be ramifications down the road. Stoner noted most technicians do their work solo, without the supervision of a department head or the ship commanding officer, and everyone is relying on sailors to do the work correctly and without jeopardizing their own safety, that of those around them or that of the components and systems.

Palmer, who has been in the Navy for 14 years, said the Aegis VMT lets him train more students at a time and also lets him train them to more skills than before.

On capacity, he said the previous lab only let an instructor work with about three students at a time due to space limitations of everyone needing to crowd around the same hardware. With VMT, an instructor could teach a dozen or more students, or a single primary instructor at Dahlgren could be working with adjunct instructors at the waterfront schoolhouses, or the instructor could be coordinating with sailors on ships.

Palmer also said it lets him teach students things that would be too risky to do before — chiefly, to practice reconfiguring software. Previously, trying to reconfigure software on the actual ship set, if done wrong, could create a big maintenance bill and take down the equipment for days.

On the virtual trainer, Palmer said, students can try to rework the software code and he can monitor from the instructor view on his own computer, noting only after the fact where missing slashes or other mistyped software code could have led to a situation where "this command would have actually wiped the entire program."

He added that students gain a lot of confidence knowing "I've already practiced this on a system that can't break" before they go to perform the same task on a real combat system component.

CONTINUOUS LEARNING

Brian Deters, the executive director at SCSTC, said Aegis VMT represents the Navy acknowledging that, "with the growing complexity of the combat system, which is ever increasing, that we have to have more modern methods of delivering the training or we're just going to get left behind."

Larry Sharp, the director of technical support at the command, said past trainers have had something like 50 work items that could be practiced. With Aegis VMT virtualizing the combat system down to individual wires, instructors can pick from 10,000 potential faults to introduce into training.

Deters said this can help students start to understand the cause and effect of one component being broken and affecting the output on a display elsewhere in the combat system.

Stoner said the trainer and curriculum are also flexible enough to keep up with trends in the fleet.

The focus of the schoolhouse in Dahlgren and the future ones in fleet concentration areas is to teach apprentice-level sailors how to do maintenance and restore casualties on ships. The technology, though, could be used throughout a sailor's career, teaching journeyman-level sailors how to supervise young technicians, for example.

"It's really limited only by our imagination on where we want to take it," Deters said.

AR15/M4
StripLULA®
5.56 10rd stripper-clip mag loader



SL50B - NSN 1005310167299

UpLULA®
9mm - .45ACP universal
pistol mag loader
& unloader



UP60B - NSN 1005310172705

AR15/M4
BenchLoader®
5.56 heavy-duty
30rd mag loader



BL71B - NSN 1005310173431

GSA Advantage!

**World's best selling
magazine loaders !**

Over thirty professional pistol & rifle
mag loaders - Made in Israel

maglula Ltd.
Since 2001

DRUG PRICES ON THE RISE ★ VAX WAIVERS WILL BE RARE

AirForceTimes

PROUD TO SERVE THOSE WHO SERVE™



TOP EMPLOYERS
NEW RANKINGS!



BATTEN DOWN THE HATCHES

HOW THE AIR FORCE IS PREPARING FOR ANTI-SHIP WARFARE



MIDEAST MISSIONS CONTINUE

LEADERS STILL
WORRY ABOUT BAD
ACTORS IN CENTCOM

COMPASS CALL SQUADRON IS FINALLY HOME

AMAZING RESCUE IN ALASKA

NOVEMBER 2021
VOL. NO. 82 ISSUE NO. 11
NOT A US AIR FORCE PUBLICATION

\$3.99

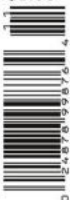

THANK YOU, VETERANS

On **Veterans Day**, we celebrate the men and women who took the oath to serve the nation.

Today, and every day, we thank you for answering **the call to serve**.



#HonorThroughAction

USAA.COM/VETERANS DAY

USAA means United Services Automobile Association and its affiliates. © 2021 USAA. 273852 - 1121

explained, but the chances of fighter, tanker or mobility aircraft units coming home from air bases like Incirlik in Turkey or Al Dhafra in the United Arab Emirates are slim.

OVER THE HORIZON

Indeed, the Air Force probably isn't done with Afghanistan. Militant organizations such as the Islamic State group's local branch, ISIS-Khorasan, and al-Qaida are still present there. The Biden administration has repeatedly stressed it plans to conduct so-called over-the-horizon airstrikes if terrorists pose a threat to the U.S., which will require a continued Air Force presence — including fighters or bombers to carry out strikes; intelligence, surveillance and reconnaissance aircraft; drones; and other support aircraft and functions such as tankers.

Air Force Secretary Frank Kendall and Chief of Staff Gen. CQ Brown said in September that over-the-horizon strikes would not look considerably different than previous airstrikes in the region, although U.S. Air Forces Central chief Lt. Gen. Gregory Guillot was still ironing out the details.

"We've been doing over-the-horizon support [of] counterterrorism operations for a long time," Kendall said at the Air Force Association's annual conference. "It's a question of scale, as much as anything at this point."

Carlisle said the military must figure out exactly what it wants from over-the-horizon missions. Would they be used to observe terrorist training camps using ISR aircraft and then, if necessary, calling in an airstrike? Or would that capability be used to bomb a "single bad actor terrorist?" he wondered. And how would this work when the U.S. doesn't recognize Afghanistan's Taliban-run government?

Tension with Iran also remains high, which Carlisle said will further require the Air Force to remain in the region. The Pentagon has alleged Iran is backing, among others, the militia groups Kata'ib Hezbollah and Kata'ib Sayyid al-Shuhada in Syria, and said they carried out drone attacks against American personnel and facilities in Iraq. The U.S. has twice this year carried out airstrikes along the Iraq-Syria border against the groups and their facilities.

The U.S. also wants to keep open the Strait of Hormuz, the only way for ships to exit the Arabian Gulf to open seas. Iran has periodically threatened to block the vital conduit for oil shipments and other commerce.

For "the land component [of the military], leaving Afghanistan had a pretty large impact," Carlisle said. "I think that naval, air and space components are going to still find a big demand signal coming from that part of the world."

But losing air bases in Afghanistan — most notably Bagram Airfield near Kabul and Kandahar Airfield in the na-

tion's southern region — limits America's ability to conduct counterterrorism operations in the region.

Other local bases have the capacity and flexibility to absorb operations that once operated out of Afghanistan, Carlisle said, but U.S. pilots will have to fly farther, which harms response times and requires additional support from tankers.

"Speed, range and payload are going to be a factor," Carlisle said. "I know the Air Force is looking hard at this."

THE USEFULNESS OF DRONES

Remotely piloted aircraft have been particularly useful in the region over the last two decades, Carlisle said, and that will likely continue — particularly toward keeping an eye on Iran.

Venable said he expects drones to come in handy for over-the-horizon efforts related to targets in Afghanistan, particularly because flying manned aircraft over that nation

has become considerably more risky since the Taliban's takeover. If an aircrew goes down in the Taliban-controlled nation, a combat search-and-rescue team would have to extract them before they are captured. Such a team taking off from the Gulf would face long flight times, require midair refueling and a need to negotiate with Pakistan for a safe air route, among other complications.

But a drone crashing in Afghanistan is simply a loss of hardware, Venable said.

To support its drone capabilities, the U.S. might seek a deal with a nation bordering Afghanistan to allow clandestine UAV bases, Venable said. But given Russian influence in the region, the Taliban's strength and the way in which the U.S. left Afghanistan, that might be

difficult, he said, even with a friendly nation like Uzbekistan.

"Uzbekistan [doesn't] want regional trouble," Venable said. "And after the United States pulled the plug on Afghanistan and left all of our allies in the lurch, why would they bet on us? For now, I think they're going to sit back and wait for things to settle down before they'll allow us to operate — clandestinely or officially — out of their country."

That will mean flying drones or manned aircraft to Afghanistan out of Al Dhafra and Al Udeid Air Base in Qatar, he said. But again, that means flying around Iran and through Pakistani airspace — known to pilots as the boulevard.

"The trip itself ... is not too arduous, it's just a long flight," Venable said.

While the U.S. might shift its posture in the region, Carlisle said, American allies and partners there should expect a continued American role.

"I think there was a mistaken belief that we're out of Afghanistan so we're out of the Middle East," Carlisle said. "There couldn't be anything further from the truth."

"WE'VE BEEN DOING OVER-THE-HORIZON SUPPORT [OF] COUNTERTERRORISM OPERATIONS FOR A LONG TIME. IT'S A QUESTION OF SCALE, AS MUCH AS ANYTHING AT THIS POINT."

— Air Force Secretary Frank Kendall

AR15/M4
StripLULA®
5.56 10rd stripper-clip mag loader



SL50B - NSN 1005310167299

UpLULA®
9mm - .45ACP universal pistol mag loader & unloader



UP60B - NSN 1005310172705

AR15/M4
BenchLoader®
5.56 heavy-duty 30rd mag loader



BL71B - NSN 1005310173431



GSA Advantage!

World's best selling magazine loaders!

Over thirty professional pistol & rifle mag loaders - Made in Israel

maglula Ltd.
Since 2001

NEW EXTREMISM DEFINITION ★ SPEC OPS SOLDIERS EVADE NINJA

ArmyTimes

PROUD TO SERVE THOSE WHO SERVE™



TOP EMPLOYERS
NEW RANKINGS!

DISINFORMATION AND DISEASE INSIDE AN ARMY MEDICAL TEAM'S FIGHT WITH COVID



NVG RAID

SOME OF FORT HOOD'S
100 MISSING NVGS
RECOVERED

COVID VAX WAIVERS WILL BE RARE

IVAS GOGGLES PROJECT AUDITED

NOVEMBER 2021
VOL. NO. 82 ISSUE NO. 11
NOT A US ARMY PUBLICATION

\$3.99

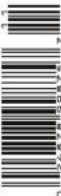

THANK YOU, VETERANS

On **Veterans Day**, we celebrate the men and women who took the oath to serve the nation.

Today, and every day, we thank you for answering **the call to serve.**



#HonorThroughAction

USAA.COM/VETERANS DAY

USAA means United Services Automobile Association and its affiliates. © 2021 USAA. 273852 - 1121



NVGs, but in red
A U.S. soldier adjusts his night vision goggles at Qayyarah West Airfield, Iraq, Oct. 25, 2016.

HOMELAND SECURITY RECOVERS NVGS STOLEN FROM FORT HOOD

By Davis Winkie
davis.winkie@militarytimes.com

Federal and local law enforcement agencies in Texas have recovered some — but not all — of the night-vision goggles missing from Fort Hood in a series of raids, Army Times has learned.

Army Times first confirmed the theft of more than 100 NVGs from a maintenance facility at Fort Hood earlier this year.

NVGs are considered extremely sensitive items throughout the military, and units will often lock down their perimeter and organize massive search parties for even one missing device.

The new details come from documents obtained via the Texas Public Information Act and conversations with a source with direct knowledge of the investigation.

An attorney for the city of Corpus Christi, Texas, attempted to block the release of records associated with the investigation, but the office of Texas Attorney General Ken Paxton ruled in favor of Army Times and directed the city to release the documents.

The effort to recover the devices is being carried out under a joint investigation involving Homeland

Security, the Postal Inspection Service, Army CID and local law enforcement departments, the source said. Homeland Security Investigations is the lead agency on the case.

All law enforcement agencies associated with the case declined to publicly comment or confirm the case's details when contacted by Army Times, citing the ongoing investigation.

Investigators believe that the NVGs were stolen from shipping containers between March and May, according to the source.

Typically, NVGs are secured in a unit's arms room, behind a vault door. But when they are being phased out or are undergoing maintenance, NVGs may be stored in a less secure manner because not all maintenance shops are equipped with heavy vaults like those found in arms rooms.

Some of the stolen devices were tracked to Corpus Christi when they were listed for sale on eBay with their serial numbers showing, the source said.

Investigators quickly identified a person of interest, Nathan Nichols, and obtained a search warrant, according to the source. Attorneys listed for Nichols in court filings from an ongoing federal

gambling conspiracy case did not respond to emails from Army Times.

Homeland Security Investigations and local police executed a joint raid on Nichols' Corpus Christi home on July 9, according to the source and an incident report obtained via the Texas Public Information Act.

Nichols and his wife were detained at a nearby traffic stop during the raid, the report said.

According to the source, the raid recovered dozens of NVGs, including thermal sights, infrared lasers and goggles. But not all of them were recovered — some devices had sold and shipped before the raid occurred.

Army Times could not confirm how many NVGs were recovered and how many were sold.

Public federal court records do not contain any new charges for Nichols related to the NVGs, but charges and search warrants in sensitive homeland security cases are often kept under seal.

The source said Homeland Security Investigations also carried out at least one additional raid related to the NVG thefts. The more recent raids targeted an Army contractor near Fort Hood believed to have assisted in the heist, the source added.

SFC CHRISTOPHER BRECHT/ARMY

AR15/M4
StripLULA®
5.56 10rd stripper-clip mag loader



SL50B - NSN 1005310167299

UpLULA®
9mm - .45ACP universal
pistol mag loader
& unloader



UP60B - NSN 1005310172705

AR15/M4
BenchLoader®
5.56 heavy-duty
30rd mag loader



BL71B - NSN 1005310173431

GSA Advantage!

**World's best selling
magazine loaders !**

Over thirty professional pistol & rifle
mag loaders - Made in Israel

maglula Ltd.
Since 2001

November 2021 ARMYTIMES.COM 9

BIRTHDAY BALLS CANCELED ★ LAW ENFORCEMENT BATTALIONS SHUTTERED

CORPS MarineTimes

PROUD TO SERVE THOSE WHO SERVE™



TOP EMPLOYERS
NEW RANKINGS!

DUAL DEVOTION

A SIKH MARINE
CAN NOW WEAR A
TURBAN. HE SAYS
THAT'S NOT ENOUGH



NEW RULES

EVERYTHING YOU NEED
TO KNOW BEFORE
YOUR NEXT TATTOO

VIRAL OFFICER SENTENCED

VACCINE WAIVERS WILL BE RARE

NOVEMBER 2021
VOL. NO. 23 ISSUE NO. 11
NOT A USMC PUBLICATION

\$3.99



THANK YOU, VETERANS

On **Veterans Day**, we celebrate
the men and women who took the
oath to serve the nation.

Today, and every day, we thank
you for answering **the call to serve.**



#HonorThroughAction

USAA.COM/VETERANS DAY

USAA means United Services Automobile Association and its affiliates. © 2021 USAA. 273852 - 1121



SLEEVES ARE OFFICIALLY BACK

MARINE CORPS MAKES BIG CHANGES TO TATTOO POLICY

By Philip Athey
 pathay@militarytimes.com

The Marine Corps launched its new tattoo policy Oct. 29, which brings back sleeves and ditches any rank-specific restrictions in an effort to improve retention and recruitment.

Marines can now sport an unlimited number of tattoos on any body part, except the face, neck and hands, with the exception of a single ring-like tattoo on one finger.

"The decision to change the policy came after a months long-review of existing regulations which were believed to have an adverse effect on retention and recruiting efforts," said Headquarters Marine Corps spokesman Maj. Jim Stenger.

"A panel of Marines from various backgrounds and ranks recommended changes to the policy," Stenger said.

The panel consisted of dozens of Marines of various ranks from lance corporal to colonel, and consisted of almost 30 different military occupational specialties, an official familiar with the panel told Marine Corps Times on the condition of anonymity.

The Corps said the new policy upholds the traditions of the Corps while better aligning with current societal trends.

"The American people expect Marines to be disciplined, physically fit, and ready to accomplish any mission," the Marine Corps bulletin announcing the policy said. "They also expect Marines to represent the nation they are sworn to protect."

This bulletin "ensures that the Marine Corps maintains its ties to the society it represents and removes all barriers to entry for those members of society wishing to join its ranks," it added.

Beyond adjusting to current social norms and increasing the pool of potential recruits, the Corps has made the change as it looks at increasing retention.

The Corps is currently increasing its investment in the level of training Marines receive throughout their careers as

it prepares to fight a more complicated future war with small highly dispersed units.

Marine Corps Commandant Gen. David Berger and Sergeant Major of the Marine Corps Troy Black have both said the Corps needs to rethink its treatment of Marines to ensure that those increased investments are not wasted.

"We buy service members for a contract, I would offer we need to think a little longer," Black said in August at the 2021 Sea Air Space conference at National Harbor, Maryland.

"We have so much invested in training and education right now in the first term of a Marine's career, we need to keep that (Marine)," Black added.

WHAT CHANGED?

The new policy seeks to simplify the Marine Corps' rules around tattoos by bringing all Marines, regardless of rank or billet, to the same standard.

Under the old policy, issued in 2016, enlisted Marines were allowed an unlimited number of tattoos, as long as they did not have a sleeve. Officers and officer candidates, however, were limited to four tattoos that were visible in the Marine Corps physical training uniform.

Under the new standard all Marines will be allowed an unlimited number of tattoos, along with tattoos on the knees and elbows, heralding the long-sought return of sleeves.

The sleeves or any other tattoo on the lower arm, "may extend down no further than a line around the circumference of the wrist measured at the wrist bone," the current bulletin stated.

Chest and back tattoos must remain below the collarbone and seventh cervical vertebrae and must be fully covered by a "properly fitting crewneck T-shirt with no portion of the tattoo showing," the bulletin said.

See **TATTOOS** page 10

AR15/M4
StripLULA®
 5.56 10rd stripper-clip mag loader



SL50B - NSN 1005310167299

UpLULA®
 9mm - .45ACP universal
 pistol mag loader
 & unloader



UP60B - NSN 1005310172705

AR15/M4
BenchLoader®
 5.56 heavy-duty
 30rd mag loader



BL71B - NSN 1005310173431

GSA Advantage!

**World's best selling
 magazine loaders !**

Over thirty professional pistol & rifle
 mag loaders - Made in Israel

maglula Ltd.
 Since 2001

MARINE CORPS

DRUG PRICES ON THE RISE ★ VAX WAIVERS WILL BE RARE

NavyTimes

PROUD TO SERVE THOSE WHO SERVE™



TOP EMPLOYERS
NEW RANKINGS!

'UNACCEPTABLE'

ARSON CAUSED THE BONHOMME RICHARD FIRE, BUT A HOST OF NAVY FAILURES DOOMED THE AMPHIB



LOWERING THE BOOM

A DISCHARGE PLAN FOR SAILORS WHO REFUSE VACCINE

A PORT SERVICES SCANDAL — AGAIN

NAVY TO REEVALUATE DISCHARGES INVOLVING PTSD

NOVEMBER 2021
VOL. NO. 71 ISSUE NO. 11
NOT A US NAVY PUBLICATION

\$3.99



THANK YOU, VETERANS

On **Veterans Day**, we celebrate the men and women who took the oath to serve the nation.

Today, and every day, we thank you for answering **the call to serve**.



#HonorThroughAction

USAA.COM/VETERANS DAY

USAA means United Services Automobile Association and its affiliates. © 2021 USAA. 273852 - 1121

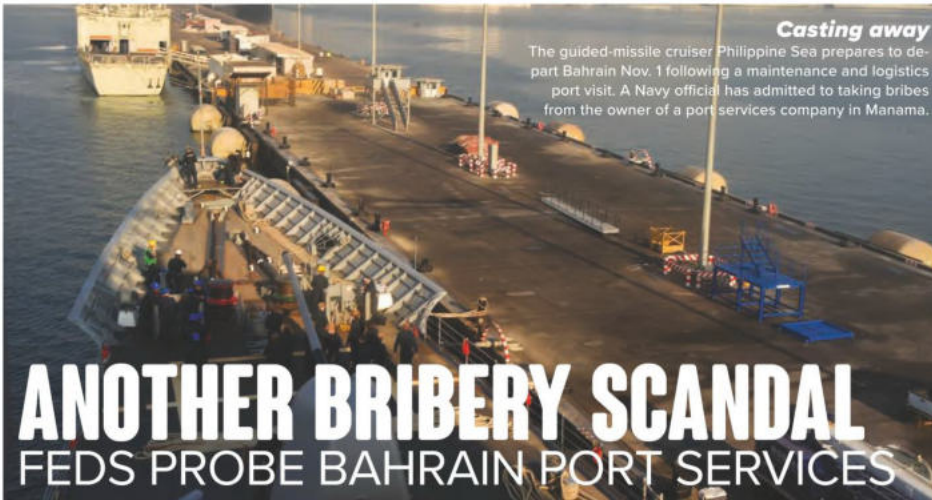

Casting away

The guided-missile cruiser Philippine Sea prepares to depart Bahrain Nov. 1 following a maintenance and logistics port visit. A Navy official has admitted to taking bribes from the owner of a port services company in Manama.

ANOTHER BRIBERY SCANDAL FEDS PROBE BAHRAIN PORT SERVICES

By Geoff Ziezulewicz
geoffz@militarytimes.com

A Navy official in charge of port service contracts for the U.S. 5th Fleet in Bahrain has admitted to taking tens of thousands of dollars in bribes from the owner of a company providing those services, according to recently unsealed court records of a probe that carries stark similarities to the Navy's "Fat Leonard" scandal.

Revelations around the case, first reported by The Washington Post, were laid bare with the unsealing of an arrest warrant for Frank Rafaraci, the CEO of Multinational Logistics Services, or MLS, a company that has received more than \$100 million in contracts to service U.S. ships in port since 2013. Rafaraci, a U.S. citizen who lives in Italy and the United Arab Emirates, was arrested in an unidentified country Sept. 27 at the request of the U.S. government, according to court records.

"The bribes were solicited, and Rafaraci corruptly gave, offered, and promised these things of value, as part of a course of conduct of favors and gifts flowing to (the Navy official) in exchange for a pattern of official acts favorable to Rafaraci and MLS," the warrant states.

The warrant also alleges that Rafaraci and others overcharged the Navy by at least \$50 million over the years.

In one instance, MLS had the contract to provide husbanding services to the aircraft carrier Carl Vinson when it pulled into Manama in early 2015. But while MLS only paid about \$12,600 to the Manama port authority, it submitted invoices to the Navy for more than \$231,000.

The warrant alleges that the Navy official serving as 5th Fleet's marine liaison officer took bribes from Rafaraci, even as he oversaw port service deals for contractors like MLS.

The Navy official pleaded guilty to a conspiracy to commit bribery charge in June but is only referred to as "CC-2" in the Rafaraci warrant. That official is cooperating with authorities in the hopes of getting a more lenient sentence and his case remains under seal, according to court records.

The warrant by Defense Criminal Investigative Service agent Cordell DeLaPena states that CC-2 was a Navy official at various times from October 2006 to December 2017, and from July 2020 to present.

Navy spokespeople declined to provide the official's name or confirm whether the Navy is still doing business with MLS.

The warrant alleges that Rafaraci and others "knowingly and intentionally conspired to bribe" the Navy official from 2015 to 2021.

That Navy official, the warrant alleges, "accepted and agreed to accept a 'stream of benefits' of things of value in return for being corruptly influenced by Rafaraci" and other unidentified MLS officials.

On July 11, 2015, the Navy official emailed a MLS employee with the subject line, "money," according to the warrant.

"Hello, Hope this e-mail finds you and your family in good health and spirit," the Navy official wrote. "Can I please make a loan out to you for \$20,000?"

The next month, Rafaraci emailed another MLS employee and stated he needed \$20,000 for "MLS Bahrain."

The Navy official has met with federal agents several times and "initially denied that his solicitation and acceptance of things of value from Rafaraci and MLS was connected to his official duties for the U.S. Navy," the warrant states.

The Navy official told law enforcement that he met Rafaraci at the Diplomat Hotel in Manama in August 2015 and accepted an envelope containing \$20,000 from the businessman.

Rafaraci told the official he would be in touch and to "keep up the good work," the warrant states.

The Navy official was working for the U.S. Army in March 2018 when he hit up MLS employees for another loan for \$13,500, according to the warrant.

Rafaraci met the official at a Miami hotel in May 2018 and handed over an envelope with the requested money, the official said in a statement in connection to his guilty plea, according to the warrant.

The warrant states that evidence shows the Navy official "solicited the bribes ... with the intent to be influenced in his official duties as Marine Liaison Officer."

Court records indicate he has been arrested outside the United States. U.S. Justice Department officials said Rafaraci voluntarily returned to the United States Oct. 18 and is currently out on a \$5 million bond.

AR15/M4
StripLULA®
5.56 10rd stripper-clip mag loader



SL50B - NSN 1005310167299

UpLULA®
9mm - .45ACP universal
pistol mag loader
& unloader



UP60B - NSN 1005310172705

AR15/M4
BenchLoader®
5.56 heavy-duty
30rd mag loader



BL71B - NSN 1005310173431

GSA Advantage!

**World's best selling
magazine loaders !**

Over thirty professional pistol & rifle
mag loaders - Made in Israel

maglula Ltd.
Since 2001

MCZ INDIRA BEAUFORT/NAVY

RATING PUBLIC EDUCATION NEAR YOU ★ NEW SEXUAL ASSAULT PLAN

AirForceTimes

PROUD TO SERVE THOSE WHO SERVE™



**TEMPORARY
BAH
INCREASE**

WARTHOG WARRIOR



**WITH 7,000 HOURS IN AN A-10
COCKPIT, LT. COL. JOHN MARKS
HAS SEEN AND DONE IT ALL**



FINAL MISSION

INSIDE THE B-52s'
LAST DEPLOYMENT
TO AFGHANISTAN

**C-17 CREWS'
TIRELESS EFFORT
IN AFGHANISTAN
EVACUATION
DEPLOYMENTS**

**'ACCELERATE
CHANGE'
GATHERS SPEED**

OCTOBER 2021
VOL. NO. 82 ISSUE NO. 10
NOT A US AIR FORCE PUBLICATION

\$3.99



Don't settle for basic.

usaa.com/auto



AUTO
INSURANCE

Membership eligibility and product restrictions apply and are subject to change. Auto insurance provided by United Services Automobile Association and its property and casualty affiliates, San Antonio, Texas. No Department of Defense or government agency endorsement. © 2021 USAA. 280418-0721

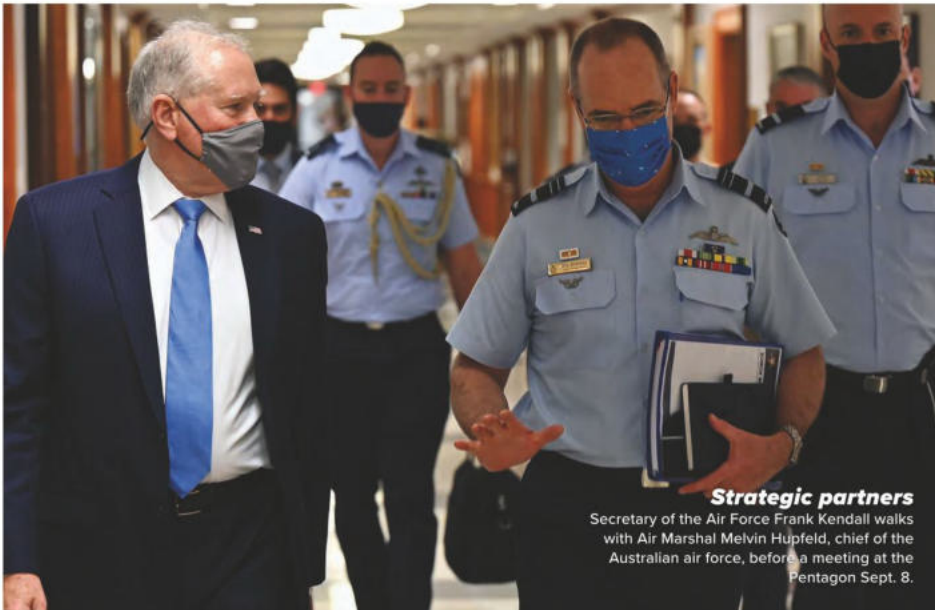

Strategic partners
Secretary of the Air Force Frank Kendall walks with Air Marshal Melvin Hupfeld, chief of the Australian air force, before a meeting at the Pentagon Sept. 8.

SECAF: 'LET US RETIRE AIRCRAFT OR WE CAN'T BEAT CHINA'

By Valerie Insinna

Air Force Secretary Frank Kendall has a message for Congress: The aircraft in your district are not exempt from the retirements the Air Force needs to free up money for next-generation planes, drones and weapons.

"I have one request of the Congress: Help us to focus on the one fight — the strategic competitive fight — we must win," Kendall said during a speech at the Air Force Association's Air, Space and Cyber conference.

"We will not succeed against a well-resourced and strategic competitor if we insist on keeping every legacy system we have," he said. "Our one team cannot win its one fight to deter China or Russia without the resources we need and a willingness to balance risk today to avoid much greater risk in the future."

"I do understand the political constraints here, and I'm happy to work with Congress to find a better

mechanism to make the changes we need, but we must move forward,"

Immediately after taking office in July, Kendall put the Air Force and Space Force to work on an intense exercise meant to overhaul the services' budget ahead of its submission to the Office of the Secretary of Defense two days later.

The resulting budget document does not comply with congressional direction to retain certain numbers of legacy aircraft, Kendall said. He did not elaborate.

In recent years, the service has shied away from seeking to retire full fleets of aircraft, as was common practice during the Obama administration.

Then the Air Force unsuccessfully tried to divest its U-2 spyplanes, RQ-4 Global Hawk surveillance drones and A-10 Warthog attack planes.

At the time, leaders said the Budget Control Act caps made it impossible to modernize the force with next-generation aircraft while at the same time hanging on to aging planes that are expensive to maintain.

Instead, over the past two years, the Air Force put forward budget proposals that called for retiring portions of certain aircraft inventories — several squadrons of A-10s, the oldest model Global Hawks and dozens of aging KC-10 and KC-135 tankers, for

example.

Kendall signaled the service could return to a more aggressive approach, where it will push lawmakers to approve the retirements of "aircraft that we no longer need and that do not intimidate China."

In an August interview with Defense News, a sister publication, Kendall said the Air Force was considering bundling aircraft divestments in a single package, which would allow the service to make cuts without having to debate each retirement individually.

"These older fleets are "consuming precious resources we do need for modernization," Kendall said at the conference.

While it's understandable that lawmakers try to protect their districts' economies, local political interests are coming at the expense of national security priorities, he added.

"It was a frequent occurrence during my confirmation process to have a senator agree with me about the significance of the Chinese threat," Kendall said. "In the same breath [they would] tell me that under no circumstances could the — take your pick — C-130s, A-10s, KC-10s, [or] MQ-9s in that senator's state be retired, nor could any base in his or her state ever be closed or lose manpower that would cause impact to the local economy."

AR15/M4
StripLULA®
5.56 10rd stripper-clip mag loader



SL50B - NSN 1005310167299

UpLULA®
9mm - .45ACP universal pistol mag loader & unloader



JP60B - NSN 1005310172705

AR15/M4
BenchLoader®
5.56 heavy-duty 30rd mag loader



BL71B - NSN 1005310173431

GSA Advantage!

World's best selling magazine loaders!

Over thirty professional pistol & rifle mag loaders - Made in Israel

maglula Ltd.
Since 2001

WAYNE CLARK/ U.S. AIR FORCE

FIRST MDO TASK FORCE IN EUROPE ★ NEW SNIPER RIFLES COMING

ArmyTimes

PROUD TO SERVE THOSE WHO SERVE™



**TEMPORARY
BAH
INCREASE**



NEW ERA
**ARMY ADJUSTS AFTER
AFGHANISTAN EXIT**



**SYRIA
GUNFIGHT**
PARATROOPER'S CASE
PREPS FOR TRIAL

**NEW ALCOHOL BAN
ON BORDER MISSION**

**MONUMENTS CHANGE
AT VMI AND WEST
POINT**

OCTOBER 2021
VOL. NO. 82 ISSUE NO. 10
NOT A US ARMY PUBLICATION

\$3.99



Don't settle for basic.
usaa.com/auto



**AUTO
INSURANCE**

Membership eligibility and product restrictions apply and are subject to change. Auto insurance provided by United Services Automobile Association and its property and casualty affiliates, San Antonio, Texas. No Department of Defense or government agency endorsement. © 2021 USAA. 280418-0721



Sunrise sappers

Vehicles from 87th Sapper Company wait in line to move Engineer Soldiers to and from the Arizona-Mexico border, Nov. 9, 2018.

ALCOHOL BAN HITS BORDER MISSION AFTER DWI DEATH INVOLVING SOLDIERS

By Davis Winkie
davis.winkie@militarytimes.com

A Georgia National Guard soldier assigned to the mission at the southwestern border was arrested and charged with manslaughter Sept. 5 — a Sunday morning.

Within hours, a ban on alcohol consumption and a new curfew for all Guardsmen on the Title 10 border mission was instated.

Spc. Bianca Farmer was driving a GSA rental vehicle with two other soldiers on Interstate 2 in McAllen, Texas, when she lost control of the vehicle and struck a pair of light poles, according to a source familiar with the incident.

The source spoke with Army Times on condition of anonymity in order to discuss an ongoing investigation.

First responders quickly arrived on scene and pronounced Spc. Nashyra Whitaker of the Louisiana National Guard deceased.

Another Georgia National Guard NCO suffered non-life threatening injuries, according to the source.

According to jail records, the McAllen Police Department arrested the driver, Farmer, and charged her with intoxicated manslaughter with a vehicle, driving while intoxicated and

intoxicated assault with a vehicle.

The soldiers were all assigned to Joint Task Force-North, which consists of more than 3,000 troops from the Guard and other components of the military to support to U.S. Customs and Border Protection along the U.S.-Mexico border.

Eduardo Natividad, JTF-North spokesperson, told Army Times that the command “has no further information to provide” on the crash beyond the Louisiana National Guard’s public acknowledgement of Whitaker’s death.

Natividad only added that “there is currently an ongoing investigation.” The crash was the most recent in a string of service member deaths among the Guard troops assigned to JTF-North.

Last month, an Alabama National Guard soldier died of COVID-19 while isolating in his hotel room two weeks after a positive test.

And in July, a Louisiana National Guard soldier — who was assigned to the same company as Whitaker, the soldier killed Sunday — died when multiple civilian vehicles struck him while crossing a McAllen street at 3:30 a.m.

A source with knowledge of that incident told Army Times that officials believe the soldier was intoxicated.

Within hours of the accident, the commander of the Guard task force on the mission issued a new policy memo completely banning possession and consumption of alcohol for all Guard troops on the Title 10 border mission.

Army Times obtained a copy of the memo.

“The current environment, processes, and procedure within the Joint Operations Area of Operation Phoenix Guard are failing to prevent alcohol related misconduct,” said Col. Bradley Leonard, commander of the 110th Maneuver Enhancement Brigade and Task Force Phoenix, in the memo.

“This destructive behavior has irrevocable and fatal consequences[,] and without my immediate action, puts our [servicemembers] and civilians as well as this mission in dire risk,” Leonard added in the memo.

A 10 p.m. to 5 a.m. curfew for all troops assigned to the task force, save for those on the night shift, was also instituted by the memo.

Leonard’s order requires that all service members “will not consume or possess any alcohol,” in addition to stricter vehicle accountability measures.

“These measures will combat this destructive behavior to ensure our [servicemembers] return home alive and safe,” Leonard said.

CPT. CASEY JEMELKA/ARMY

AR15/M4
StripLULA®
5.56 10rd stripper-clip mag loader

SL50B - NSN 1005310167299

UpLULA®
9mm - .45ACP universal pistol mag loader & unloader

JP60B - NSN 1005310172705

AR15/M4
BenchLoader®
5.56 heavy-duty 30rd mag loader

BL71B - NSN 1005310173431

GSA Advantage!

World's best selling magazine loaders !
Over thirty professional pistol & rifle mag loaders - Made in Israel
maglula Ltd.
Since 2001

DEVIL DOGS SAVE MOTORISTS FROM FLOOD ★ 4 BRONZE STARS WITH 'V'

CORPS MarineTimes

PROUD TO SERVE THOSE WHO SERVE™



**TEMPORARY
BAH
INCREASE**



'A SHINING MOMENT'

AMID CHAOS AND DARKNESS, MARINES SHOWED UP



VIRAL OFFICER GOES QUIET

LIEUTENANT COLONEL
CHARGED WITH 6
MILITARY CRIMES

SIKH MARINE ALLOWED TO WEAR TURBAN

FINAL WIZZOS GET WINGS

OCTOBER 2021
VOL. NO. 23 ISSUE NO. 10
NOT A USMC PUBLICATION

\$3.99



Don't settle for basic.
usaa.com/auto



AUTO
INSURANCE

Membership eligibility and product restrictions apply and are subject to change. Auto insurance provided by United Services Automobile Association and its property and casualty affiliates, San Antonio, Texas. No Department of Defense or government agency endorsement. © 2021 USAA. 280418-0721

OFFICER WHO DEMANDED 'ACCOUNTABILITY' CHARGED WITH 6 MILITARY VIOLATIONS

By Philip Athey
pathey@militarytimes.com

A Marine lieutenant colonel who has made waves on social media the past month has formally been charged with six violations of the Uniform Code of Military Justice and has been referred to a special court-martial.

Marine Lt. Col. Stuart Scheller rose to national fame Aug. 26 when he posted a video on LinkedIn and Facebook of himself, in his Marine Corps uniform, calling for senior leaders in the Department of Defense to be held accountable for their failures in Afghanistan.

"In the military there are proper forums to raise concerns with the chain of command," Capt. Sam Stephenson, a spokesman for Training and Education Command, said in a statement emailed to Marine Corps Times Oct. 6. "In a general sense not specific to any case, posting to social media criticizing the chain of command is not the proper manner in which to raise concerns with the chain of command and may, depending upon the circumstances, constitute a violation of the Uniform Code of Military Justice."

Scheller has been charged with Article 88 (contempt toward officials), Article 89 (disrespect toward superior commissioned officers), Article 90 (willfully disobeying a superior commissioned officer), Article 92 (dereliction in the performance of duties), Article 92 (failure to obey order or regulation) and Article 133 (conduct unbecoming an officer and a gentleman), Stephenson said Oct. 6.

The first video posted by Scheller, an Afghanistan veteran himself, was after news broke that 13 service members, including 11 Marines, had been killed in a suicide bombing at Hamid Karzai International Airport in Kabul as thousands were fleeing the Taliban takeover of Afghanistan.

He immediately was fired from his position as the battalion commander of Advanced Infantry Training Battalion at School of Infantry-East at



Scrutinizing leaders

Lt. Col. Stuart Scheller was fired Aug. 27 for a viral video in which he demanded "accountability of senior leadership" during the U.S. withdrawal from Afghanistan.

Camp Lejeune, North Carolina.

Despite the reprimand, the Marine went on to post several more videos and written statements to social media where he called for accountability from specific political and military leaders, including those in his chain of command.

On Sept. 25, before his confinement, Scheller wrote a lengthy Facebook post where he criticized former U.S. Presidents Donald Trump to Barack Obama to Bill Clinton along with retired Gens. James Mattis, David Petraeus and Michael Flynn and his current chain of command before reiterating his desire to "bring the whole system down."

'THERE ARE PROPER FORUMS TO RAISE CONCERNS.'

— Capt. Sam Stephenson, spokesman for Training and Education Command

Scheller was sent to the brig Sept. 27, but was released on Oct. 5 after his lawyers came to an agreement with the Marine Corps.

The Corps would not comment on the deal made with Scheller's defense team, only saying it was "as a result of a mutual agreement between Lt. Col. Scheller, his Defense counsel, and the Commanding General, Training Command."

When news of the Marine's brig time broke, several Republican members of Congress came to the lieutenant colonel's aid, writing a letter to Marine Corps Commandant Gen. David Berger demanding the Marine be released.

During his short stint in the brig, rumors circulated that Scheller had been put in solitary confinement. Stephenson said those rumors were false.

"While Lt. Col. Scheller was in an individual cell, he was never held in solitary confinement," Stephenson said.

"He was allowed recreational time for a minimum of two hours a day and could regularly converse with other prisoners and staff, albeit socially distanced and masked when in the company of others."

AR15/M4
StripLULA®
5.56 10rd stripper-clip mag loader



SL50B - NSN 1005310167299

UpLULA®
9mm - .45ACP universal pistol mag loader & unloader



JP60B - NSN 1005310172705

AR15/M4
BenchLoader®
5.56 heavy-duty 30rd mag loader



BL71B - NSN 1005310173431

GSA Advantage!

World's best selling magazine loaders!

Over thirty professional pistol & rifle mag loaders - Made in Israel

maglula Ltd.
Since 2001

MARINE CORPS

October 2021 MARINECORPSTIMES.COM 9

COLLEGE PROGRAM GOES ONLINE ★ NEW SEXUAL ASSAULT PLAN SET

NavyTimes

PROUD TO SERVE THOSE WHO SERVE™



**TEMPORARY
BAH
INCREASE**

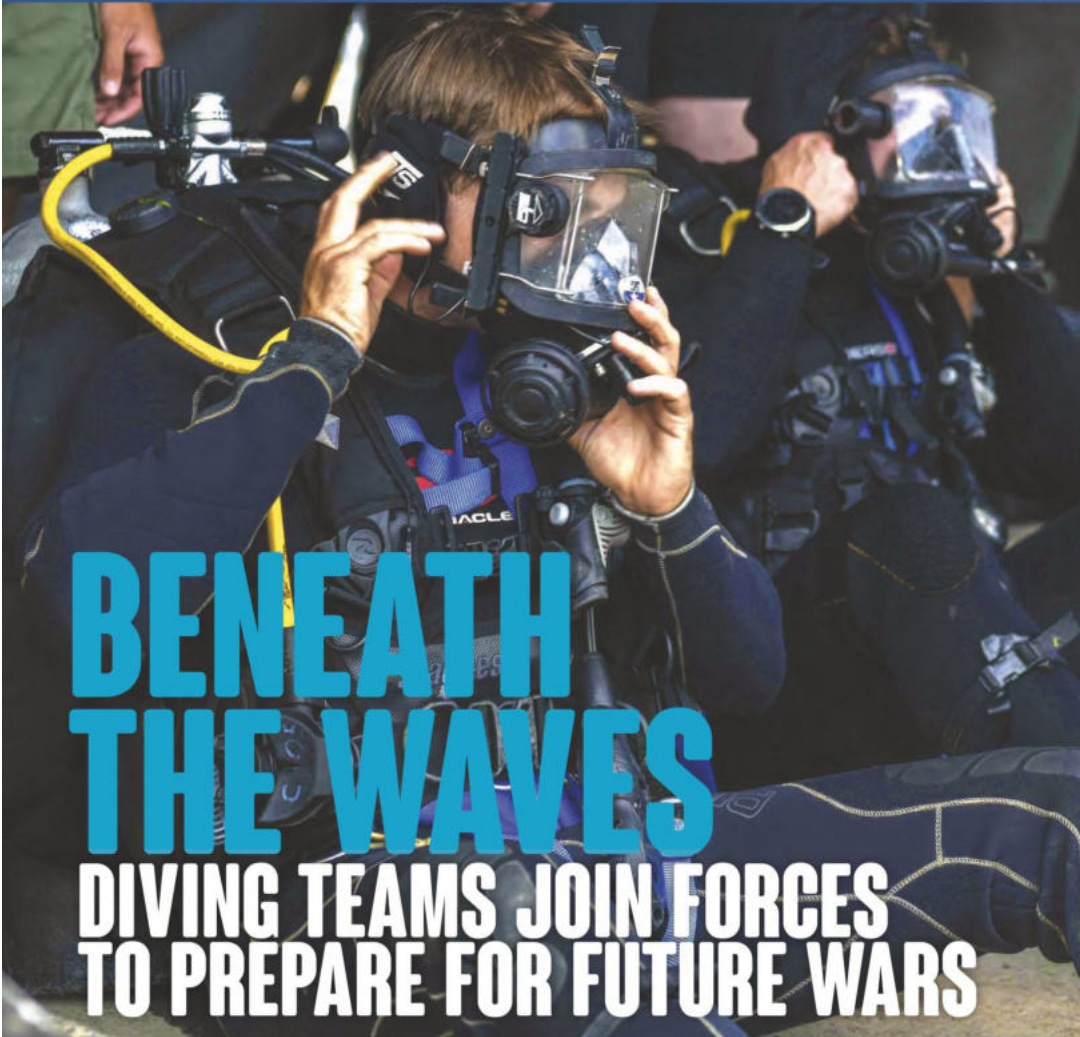

**BENEATH
THE WAVES**
**DIVING TEAMS JOIN FORCES
TO PREPARE FOR FUTURE WARS**



**RUSSIAN
SUB CONSCIOUS**
NEW TASK FORCE TAPS
DESTROYERS TO FOCUS
ON UNDERSEA THREATS

**NEW GUIDANCE
EXPECTED TO
INFORM NAVY'S
GLOBAL POSTURE**

**WHY 5TH FLEET
IS PARTNERING
WITH LEBANON**

OCTOBER 2021
VOL. NO. 71 ISSUE NO. 10
NOT A US NAVY PUBLICATION

\$3.99



Don't settle for basic.
usaa.com/auto



**AUTO
INSURANCE**

Membership eligibility and product restrictions apply and are subject to change. Auto insurance provided by United Services Automobile Association and its property and casualty affiliates, San Antonio, Texas. No Department of Defense or government agency endorsement. © 2021 USAA. 280418-0721

He also said naval presence in the Pacific and around Europe will be important and must be balanced.

He also told reporters that the Global Posture Review “drew some conclusions before the drawdown from Afghanistan” that would have to be revisited once the counter-VEO tactics were hashed out, but he did not provide a time frame.

Gilday told Defense News, a sister publication, during the call with reporters that the Navy needs to shift its mindset to prepare for deployments to areas of competition.

“I don’t think that the United States necessarily needs to be provocative; I do think we need to be out there, I do think we need to be out there in numbers,” he said.

“It’s why readiness and training have been my top priority right in the beginning — is that it doesn’t matter how big a navy you have if you can’t sustain it, if it isn’t ready to go, if its magazines aren’t full of ammunition, if you don’t have the right people in the billets on those ships, if you don’t have the right training, if you don’t have parts in store-rooms.”

Navy Secretary Carlos Del Toro was also at the symposi-

um, during which he gave one of his first major speeches since being sworn in Aug. 9.

“The United States believes that every nation has a right to defend itself when truly threatened — when truly threatened. Every nation has a right to build, exercise and operate military forces to protect legitimate national security interests — legitimate national security interests. Every nation has the right to promote prosperity, opportunity and innovative capabilities of its own people. And every nation has the right to navigate the sea lanes and the skies in accordance with international laws,” he said.

“But no nation — and I say this again — no nation has the moral high ground to deny these rights to its peaceful neighbors,” Del Toro said. “No nation has the right to claim longstanding international waters as their own. No nation has the right to sponsor cyber crime and theft. And no nation has the right to endanger sailors and pilots with reckless approaches and harassing, bullying behaviors.

“Our hand will always be extended to any nation willing to support and defend the international norms that we depend upon.”

SENATE RAISES BAR FOR EARLY SHIP RETIREMENTS

SECNAV WOULD HAVE TO DEFEND REQUESTS BASED ON SIX CRITERIA

By Megan Eckstein
meckstein@militarytimes.com

The Senate Armed Services Committee is considering requiring the Navy to better defend its requests to retire ships before the end of their expected service lives.

It’s version of the fiscal 2022 defense policy bill would allow the Navy to retire ships early only if the secretary of the Navy signs a waiver certifying that:

- Maintaining the battle force ship in a reduced operating status is not feasible
- Maintaining the ship with reduced capability is not feasible
- Maintaining the ship as a Navy Reserve unit is not feasible
- Transferring the ship to the Coast Guard is not feasible
- Maintaining the ship is not required to support the most recent national defense strategy
- Maintaining the ship is not required to support operational plans of any combatant commander

The secretary would also have to elaborate on the last two points, explaining how losing the ship would still allow the Navy to meet its obligations to regional combatant commanders and to the overall defense strategy.

This language follows the Navy’s request to decommission seven cruisers and four littoral combat ships in FY22.

The four LCSs are young ships; the oldest, Fort Worth, was commissioned nine years ago, and the youngest, Little Rock, was commissioned just four years ago. The LCS was



built for 25 years of operations. Though the Navy says it doesn’t have the money to fix these particular hulls for combat in a contested environment, lawmakers have argued the ships would be helpful in, for example, U.S. Southern Command, assisting the Coast Guard in conducting anti-drug-trafficking missions.

Some of the seven cruisers have reached the end of their service lives while others would be retired early. In fact, some of the 22 cruisers in the fleet have gone through life-extension programs and others haven’t, creating confusion about what counts as retiring a ship early and what counts as getting rid of ships ready for decommissioning.

To address this issue, SASC also included a provision in its NDAA language that would require the Navy to note in its annual long-range shipbuilding plan the current expected service life of each ship — either the original number from when the ship was designed, or the updated service life after the Navy invested time and money into extending the life of a ship, which the Navy has done recently for much of the surface fleet and for some of its submarines.

The House Armed Services Committee included a provision in its version of the NDAA to fund the maintenance and operations of three cruisers, while allowing the other four and the LCSs to retire. Once the bills are debated and passed in their full chambers, HASC and SASC will meet later this year to hash out the differences between the bills.

AR15/M4
StripLULA®
5.56 10rd stripper-clip mag loader



SL50B - NSN 1005310167299

UpLULA®
9mm - .45ACP universal
pistol mag loader
& unloader



JP60B - NSN 1005310172705

AR15/M4
BenchLoader®
5.56 heavy-duty
30rd mag loader



BL71B - NSN 1005310173431

GSA Advantage!

**World’s best selling
magazine loaders !**

Over thirty professional pistol & rifle
mag loaders - Made in Israel

maglula Ltd.
Since 2001

October 2021 NAVYTIMES.COM 9

NEW SECAF WANTS TO 'SCARE CHINA' ★ SPACE FORCE EYES NEXT STEPS

AirForceTimes

PROUD TO SERVE THOSE WHO SERVE™



LEAVING THE LONGEST WAR



THE STATE OF THE AIR FORCE

WHAT LIES AHEAD FOR STRATEGY, OPERATIONS AND FORCE DEVELOPMENT



PME ACTION PLAN COMING THIS FALL

AIRMEN'S INPUT SOUGHT TO BUILD BETTER LEADERS

CHINA, RUSSIA LOOM OVER OPS

THE OUTLOOK FOR PROMOTIONS

SEPTEMBER 2021
VOL. NO. 82 ISSUE NO. 9
NOT A US AIR FORCE PUBLICATION

\$3.99



MADE FOR GETTING IT RIGHT

When it comes to the important stuff, you won't settle for less than the best.

We're here to give you the service you need and the commitment you deserve.

USAA means United Services Automobile Association and its affiliates.
© 2021 USAA. 276388 - 0121





'Unconstrained' thinking

NCO Academy students listen as CMSgt. Diana Mosely, the 82nd Training Wing command chief master sergeant, talks to them about polishing their skills as leaders and mentors at Sheppard Air Force Base, Texas, Oct. 3, 2019.

A HISTORY OF CHANGES

PME is a frequent subject of scrutiny and has undergone several changes in recent years — including dumping a combined in-person and remote-learning system that began in 2014.

The Air Force said enlisted PME would become fully in-residence for active-duty airmen, and it expanded eligibility to those who had spent too few or too many years in service than what was needed to sign up. Just last year, the Air Force began allowing all pregnant and postpartum airmen to attend PME, rather than needing to seek a policy exception to join.

Revamping learning for the digital age has been a major focus elsewhere in the service in the past few years as well. Air Education and Training Command has incorporated augmented and virtual reality, and computer tablets with preloaded courses, into pilot and maintainer classes to let airmen move at their own speed — which has proven faster than traditional classroom learning. That may serve as a blueprint for the enlisted force as it looks to get creative with its own curriculum and pace of teaching.

The ongoing coronavirus pandemic may shape those ideas as well.

"The pandemic forced us to learn how to communicate well through virtual means, and I think we'll take that with us," Bass said. "But we have to balance that with also being able to enjoy the benefits of face-to-face [interaction]."

A recent officer-focused study by the federally funded think tank Rand Corp. suggested Air Force PME could be overhauled further, including relocating courses from Maxwell Air Force Base, Alabama, which hosts the Senior

NCO Academy and much of the service's professional education. There are about a dozen NCO Academy locations worldwide, and about 70 Airman Leadership School sites.

"Stakeholders consistently noted that it would be easier to attract quality speakers and faculty at a more appealing location, and personal and family factors are highly cited influences on officers' preferences for [intermediate and senior developmental education] options," Rand researchers wrote. "It is no secret that the public school system is not optimal, and appealing career options for spouses are also likely limited."

FRONTLINE LEADERS

Bass hopes rethinking enlisted education will shape more effective frontline supervisors, who act as mentors and teachers within a squadron. They are expected to be a resource for airmen on the job as well as in their personal lives, like spotting red flags for suicide.

In June, Lt. Col. Kevin Scholz, commander of the 736th Aircraft Maintenance Squadron at Dover Air Force Base, Delaware, argued that the role of frontline supervisors has shrunk since he entered the service in 1992.

Squadron commanders and master sergeants took on tasks like handling rule infractions and certain training instead of relying on lower-level supervisors.

"Reinvigorate your staff and technical sergeants by delegating their rightful authority back to them," Scholz wrote in an Air Force commentary. "That authority and responsibility is taught in Airman Leadership School, but so many times is not taken back to the work centers after graduation" because of the new norms.

"In order to ensure these efforts are working, you must continuously evaluate the effectiveness of your supervisors and coach and mentor them as required. These skills aren't automatic and need to be nurtured by leadership," he added.

Enlisted airmen could also take cues from the Space Force, which is creating a new approach to military learning that better fits the service's needs.

Vice Chief of Space Operations Gen. David "DT" Thompson told Air Force Times on Aug. 12 that because of the technical nature of space-related combat jobs, the Space Force will push guardians to pursue higher levels of specialized training rather than a more general education.

"For engineers, it might be advanced degrees. For operators, it might be everyone is required [to have] some level of advanced training," he said. "For all of them, a deeper level of understanding of how the domain works and the systems that work. For our intelligence professionals, additional advanced education and training in how our adversaries may think or the ability to do strategic assessments."

Bass told Air Force Times she's keeping an eye on issues where the Space Force may be taking the lead, so the Air Force could follow suit. Digital literacy is one such priority for leadership in both services. Still, she said she's not working on adopting any specific measures right now.

"While we are unique and appreciate the uniqueness of each one of our services, we can learn from each other," she said. "If we don't have to recreate the wheel, we will have synergies together."

AR15/M4
StripLULA®
5.56 10rd stripper-clip mag loader



SL50B - NSN 1005310167299

UpLULA®
9mm - .45ACP universal
pistol mag loader
& unloader



UP60B - NSN 1005310172705

AR15/M4
BenchLoader®
5.56 heavy-duty
30rd mag loader



BL71B - NSN 1005310173431

GSA Advantage!

**World's best selling
magazine loaders !**

Over thirty professional pistol & rifle
mag loaders - Made in Israel

maglula Ltd.
Since 2001

JOHN INGLE/AFR FORCE

MANY ARMY TASERS DON'T SHOCK ★ TROOPS TEST NEW IRON DOME

ArmyTimes

PROUD TO SERVE THOSE WHO SERVE™



LEAVING THE LONGEST WAR

FIGHTING AN INVASION

ARMY SOF RETURNS TO ITS RESISTANCE ROOTS

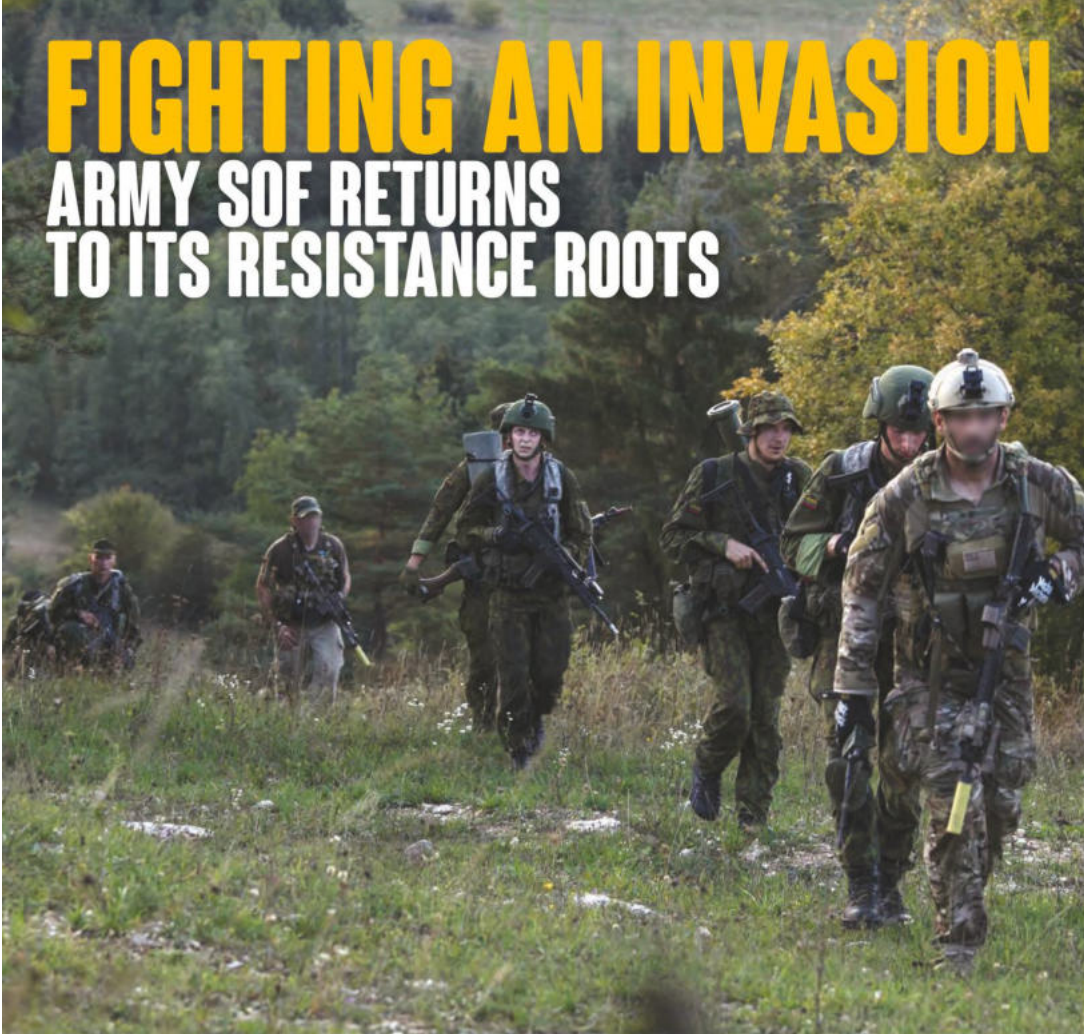

'NO PROBABLE CAUSE'

FORT SILL ENDS MASS SEX ASSAULT INQUIRY

FORT JACKSON BCT CHANGES

BARRACKS OVERHAUL

SEPTEMBER 2021
VOL. NO. 82 ISSUE NO. 9
NOT A US ARMY PUBLICATION

\$3.99



MADE FOR GETTING IT RIGHT

When it comes to the important stuff, you won't settle for less than the best.

We're here to give you the service you need and the commitment you deserve.

USAA means United Services Automobile Association and its affiliates.
© 2021 USAA. 276388 - 0121





'NO PROBABLE CAUSE'

FORT SILL SEX ASSAULT ALLEGATIONS NOT SUBSTANTIATED, ARMY SAYS

By **Davis Winkie**
davis.winkie@militarytimes.com

The Army will not bring criminal charges against Fort Sill, Oklahoma, drill sergeants and instructors accused of sexual assault earlier this year, officials announced Aug. 19.

"Military prosecutors determined...they had no probable cause to believe the allegations occurred," said Maj. Gen. Kenneth Kamper, the installation's commanding general. "I have confidence in the independent military prosecutor's determination."

Kamper said he did not have a role in the decision not to charge the instructors, who were suspended during the investigation and are returning to their duty positions immediately.

Other panelists in the news conference spoke on background.

A special victims prosecutor said that they "looked at any [Uniform Code of Military Justice] article that could apply to the investigation," including Article 93a, which criminalizes even consensual sexual contact between military instructors and their trainees.

"At the conclusion of that review, our determination was that the evidence did not substantiate the allegation," the prosecutor said.

Army officials also refused to disclose how many instructors were named in the investigation due to privacy concerns, yet they specified the number of Advanced Individual Training troops who made sexual assault reports — three — and told reporters that they were no longer in the Army for reasons unrelated to their reports.

"We're gonna focus on the outcome of this investigation and honor the privacy of all parties involved in this case," said a staff judge advocate spokesperson. "As you know, these allegations had significant impact on many, many people. And we acknowledge and understand that this has caused tremendous stress for many people to include those who were named in this investigation and their family members."

The Intercept reported in March that 22 soldiers allegedly assaulted one of the soldiers who made a sexual assault

report. At the time, a person familiar with the incident told Army Times that more than 20 individuals were under investigation in the wake of the initial report.

The two additional individuals reported their sexual assaults during extensive interviews conducted by the Army's Criminal Investigative Command, known as CID.

An Army criminal investigator associated with the case said CID special agents conducted over 700 interviews and reviewed documents, security camera footage and text messages related to the allegations.

The FBI also assisted on the case, the investigator said.

Despite the high-profile case ending in unsubstantiated allegations and the trainees' purportedly unrelated departure from the Army, Kamper encouraged survivors of sexual assault to report their experiences.

"So we take every report of sexual assault or sexual harassment with the utmost seriousness," Kamper said. "We encourage reporting because our goal is to root out harmful behaviors that negatively impact our ability to build cohesive teams where everyone has the opportunity to thrive and reach their full potential."

Kamper left the teleconference before taking any questions.

Before taking the reins at Fort Sill, Kamper was the deputy commander of Fort Hood, Texas, until February 2020.

His tenure there covered the majority of the time period chronicled by the report of the Fort Hood Independent Review Committee, but he was not named in the report.

A Rand Corporation study in March found that 31 percent of men and 28 percent of women in the military say they experienced retaliation after a sexual assault, whether they reported it or not.

And that rate increases when survivors report.

The same study found that 54 percent of women who report their assault to a mandatory reporter or file an unrestricted report experience either social or professional retaliation.

AR15/M4
StripLULA®
5.56 10rd stripper-clip mag loader



SL50B - NSN 1005310167299

UpLULA®
9mm - .45ACP universal
pistol mag loader
& unloader



UP60B - NSN 1005310172705

AR15/M4
BenchLoader®
5.56 heavy-duty
30rd mag loader



BL71B - NSN 1005310173431

GSA Advantage!

**World's best selling
magazine loaders !**

Over thirty professional pistol & rifle
mag loaders - Made in Israel

maglula Ltd.
Since 2001

MARIE PHILLIPS/ARMY

'DON'T IGNORE ACCOUNTABILITY' ★ MODERN DAY MARINE CANCELED

CORPS MarineTimes

PROUD TO SERVE THOSE WHO SERVE™



**LEAVING THE
LONGEST WAR**



**13 US TROOPS
KILLED IN
BOMBING**

READ THEIR
HEARTBREAKING
STORIES

**NAVY CROSS FOR
RETIRED RAIDER**

**MARINES SINK
REAL-LIFE SHIP**

SEPTEMBER 2021
VOL. NO. 23 ISSUE NO. 9
NOT A USMC PUBLICATION

STATE OF THE CORPS

**WHERE
MARINES
HEAD NEXT**



\$3.99



**MADE FOR
GETTING IT
RIGHT**

When it comes to the important stuff,
you won't settle for less than the best.

We're here to give you the service you
need and the commitment you deserve.



USAA means United Services Automobile Association and its affiliates.
© 2021 USAA. 276388 - 0121

ON THE RADAR

HELPING A HURTING HAITI

At least 350 Marines headed to Haiti to provide humanitarian assistance in the wake of a 7.2 magnitude earthquake on Aug. 14 that destroyed thousands of homes and affected millions of people.



1,200-MILE FLEX

In July, six UH-1Y Venoms assigned to Marine Light Attack Helicopter Squadron 169 took off from Okinawa, Japan, and conducted a 1,200-mile trip to Naval Air Facility Misawa, Japan.

PULLED TO SAFETY

A viral August video shows a harrowing scene of Marines pulling an infant over a barbed-wire barrier separating U.S. troops defending Hamid Karzai International Airport from the Taliban controlled Kabul, Afghanistan.

"The baby seen in the video was taken to a medical treatment facility on site and cared for by medical professionals," spokesman Maj. Jim Stenger said in an email at the time. "I can confirm the baby was reunited with their father and is safe at the airport." He also noted the "true professionalism" of the Marines who were on-site in Afghanistan.



MARINES MANDATE COVID-19 VACCINE

Sailors and Marines will need to be vaccinated against COVID-19 in the next 90 days or risk disobeying a lawful order and facing "punitive or administrative action or both," according to two Big Navy messages sent to the fleet the first week of September. Reserve members will have 120 days to get vaccinated, according to a message from Navy Secretary Carlos Del Toro. "The Chief of Naval Operations and Commandant of the Marine Corps have authority to exercise the full range of administrative and disciplinary actions to hold non-exempt Service Members appropriately accountable," Del Toro's message states. "This may include, but is not limited to, removal of qualification for advancement, promotions, reenlistment, or continuation, consistent with existing regulations, or otherwise considering vaccination status in personnel actions as appropriate."

SMALL UNIT MARINE LEADERS "ARE READY TO MAKE DECISIONS; I THINK AT THEIR LEVEL WE ARE SHACKLING THEM."

— COMMANDANT GEN. DAVID BERGER AT SEA-AIR-SPACE 2021.

AR15/M4
StripLULA®
5.56 10rd stripper-clip mag loader



SL50B - NSN 1005310167299

UpLULA®
9mm - .45ACP universal pistol mag loader & unloader



UP60B - NSN 1005310172705

AR15/M4
BenchLoader®
5.56 heavy-duty 30rd mag loader



BL71B - NSN 1005310173431

GSA Advantage!

World's best selling magazine loaders !

Over thirty professional pistol & rifle mag loaders - Made in Israel

maglula Ltd.
Since 2001

LANCE CPL ERIC RAMIREZ/MARINE CORPS; SCREENSHOT; MASS COMMUNICATION SPECIALIST 3RD CLASS BENJAMIN RINGERS/NAVY

NEW TRAUMA TRAINING FOR CORPSMEN ★ BIG CHANGES FOR SWOs?

NavyTimes

PROUD TO SERVE THOSE WHO SERVE™



LEAVING THE LONGEST WAR



F-35C'S FIRST CARRIER CRUISE
VINSON STRIKE GROUP SHARPENS AIR OPS

MANDATORY VACCINES COMING

NEW GROOMING REGS UNVEILED

SEPTEMBER 2021
VOL. NO. 71 ISSUE NO. 9
NOT A US NAVY PUBLICATION



DANGER BELOW
ANTI-SUBMARINE WARFARE IS NOW A 'PRIMARY MISSION' FOR EVERY SAILOR

\$3.99



MADE FOR GETTING IT RIGHT

When it comes to the important stuff, you won't settle for less than the best.

We're here to give you the service you need and the commitment you deserve.

USAA means United Services Automobile Association and its affiliates.
© 2021 USAA. 276388 - 0121



He said the new air wing proved it could bring not just greater lethality to the carrier strike group, but also greater survivability.

"Our EA-18G Growlers are kind of our cornerstone non-kinetic airborne electronic attack for the air wing. We get a couple extra ones with the air wing, which gives us a little more capacity to be able to spread that capability across," Locke said.

That extra electronic warfare capacity from the two additional Growlers in the air wing, combined with the additional E-2D for greater in-air command and control and the new stealth and advanced sensing from the F-35C, he said, keeps the whole strike group safe by "getting ahead of the threat's ability to gain information on us early on" by finding and destroying enemy sensors, networks and shooters before they can see the strike group coming.

"You really get a formidable force to go after" threats in open waters and in the littoral environment, he said.

Though the air wing had its best opportunity to develop and mature these tactics for high-end operations during Air Wing Fallon — held at a sophisticated training range — Locke said the deployment would present new learning opportunities.

First, the air wing can practice some tactics in smaller controlled areas the strike group can set up during the deployment. Second, the air wing can work with allies who also bought the F-35, integrating at the coalition level and sharing best practices. And third, he said, the air wing can learn how to contribute to other warfare commanders in the strike group and leverage their assets. Locke said the air wing didn't get to train with the strike group's destroyer squadron or information warfare commander until the final certification exercise, meaning there's plenty more work to be done to integrate and maximize each other's capabilities.

Capt. P. Scott Miller, Vinson's commanding officer, said in a separate Aug. 4 interview that the new F-35C maneuvers around the carrier and in its local air space naturally — but he said the ship has had to work hard to support the larger overall air wing.

With 67 planes in the air wing and three CMV-22s coming and going from their shore-based hubs, the ship needed to clear out more space on the deck and in the hangar.

"We give a lot of attention to the

F-35," he said, but "the behind-the-scenes increase in the number of EA-18G Growlers, two more of those, and one more E-2 has really been what's filled up the inside and the topside of the ship. And to prepare for that, we've paid particular attention to what other support equipment we have on board, and we've slimmed down or leaned down the things that we would have on board that are a bit for crew comfort. If you were on an aircraft carrier five, seven years ago, you'd see a lot of treadmills and exercise equipment kind of littering the edges of the space."

"Those are all gone now; we're to mission-essential items only as we learn how to operate with this higher operational density," Miller continued.

The ship also has to support the CMV-22B for the first time, which replaces the aging C-2A Greyhound as the carrier onboard delivery (COD) aircraft that brings people, parts and mail from the shore to the strike group at sea. The C-2A was already aging and in need of eventual replacement, but the V-22 variant was picked because of its ability to carry the large F-35 engine — something the C-2 or an updated derivative of it couldn't do. The F-35 and the V-22 are coupled together in the naval services, with the F-35 unable to deploy on carriers or amphibious ships without the V-22 nearby to fly on a replacement engine if needed.

Miller said the Navy as a whole knows how to operate the V-22 due to the Marine Corps' extensive use of the aircraft, but incorporating the tiltrotor aircraft — which sometimes flies like a plane and sometimes flies like a helicopter — into the carrier landing pattern has been an adjustment.

"It's not a fixed-wing airplane, so it doesn't land with the normal aircraft in the normal way that the C-2 did," he said. "Once it gets within very close range of the aircraft carrier, it operates a little bit more like a helicopter, in its vertical landings and [short takeoffs]."

"So instead of landing with the fixed wing, it lands with a rotary wing," Miller added. "We're learning how to operate that, we think we've pretty much figured that out."

Despite working through a few kinks in incorporating the tiltrotor into flight deck operations, Miller said the V-22 opens up a lot of possibilities for the carrier strike group. For example, the C-2 is limited to daylight operations, whereas the V-22 is certified to operate at night. While the carrier isn't using

the V-22 to send passengers to and from the carrier at night, it has been using the tiltrotor to bring supplies at night, which "has been a huge addition for us in our ability to continue doing the mission."

Leading up to the deployment, Miller said, the carrier's flight deck crew and aviation maintenance crew had to work through a range of scenarios with the V-22: What if the aircraft experienced a malfunction and came in for an emergency landing? How would the crew tow the much-larger V-22 around the flight deck and down to the hangar bay? Can the ship's aviation mechanics fix a range of potential casualties the V-22 could experience that would keep it from flying off the carrier and back to its hub ashore?

Even if the V-22 is operating as a logistics aircraft in the carrier strike group rather than a warfighting aircraft, Miller said its inclusion in the carrier strike group is making everyone safer.

"I would say as an air wing, to include the carrier onboard delivery, we were able to more confidently operate tactically and safely at a further distance from land than I've seen in my career," said Miller, a career pilot. "If we get to choose where we want to operate from, that gives us a significant tactical advantage in whatever environment we might find ourselves in."

He noted that, while the carrier wants to operate farther from enemy shores and outside the range of enemy missiles, the carrier strike group can only operate in areas where it can sustain itself. The longer legs on the V-22 "allow us to operate at those ranges that I hadn't seen before."

Though the strike group leadership declined to discuss future operational plans, they said their first mission, after recertifying the air wing, was to participate in the global Large Scale Exercise the Navy hosted for two weeks, using live, virtual and constructive participants to simulate a global warfighting effort. Prior to that exercise, Martin, the carrier strike group commander, said that after recently going through a high-end certification exercise, "we're feeling like we're bringing a good game to the exercise" and have a lot to contribute to the live portion.

"We're ready to help this exercise refine how we synchronize maritime operations across multiple fleets in support of the joint force, and we're excited to participate," he said.

AR15/M4
StripLULA®
5.56 10rd stripper-clip mag loader



SL50B - NSN 1005310167299

UpLULA®
9mm - .45ACP universal
pistol mag loader
& unloader



UP60B - NSN 1005310172705

AR15/M4
BenchLoader®
5.56 heavy-duty
30rd mag loader



BL71B - NSN 1005310173431

GSA Advantage!

**World's best selling
magazine loaders !**

Over thirty professional pistol & rifle
mag loaders - Made in Israel

maglula Ltd.
Since 2001

First, there was darkness...



World's #1 loaders !

maglula Ltd.
www.maglula.com

World's #1

Magazine Loaders and UnLoaders

Tools for Professionals !

- ✓ Save time
- ✓ No more pain
- ✓ Protect the feed lips
- ✓ Military quality

LULA® Loader & UnLoader

(US patent 6,810,616)

- AR-15 / M-16 (5.56) p/n 24215
- AK-47 & Galil (7.62 & 5.56) p/n 24216
- M1A / M14 (.308) p/n 24220
- FN FAL (.308) p/n 24221
- MP5 (9mm) p/n 24217
- Colt SMG (9mm) p/n 24218
- UZI (9mm) p/n 24219



StripLULA™ AR-15 / M-16 Stripper Clip Loader

(US and Intl. patents pending)

- Easily and quickly load rounds from 10-round stripper clips into AR-15 / M-16 (5.56) magazines.
- Fingers do not touch the rounds.
- 1/3 of the size of other loaders. p/n 24200



UpLULA™ Universal Pistol Loader

(US and Intl. patents pending)

- One size fits all, no inserts or adjustments.
- Loads virtually all 9mm, .357, 10mm, .40, and .45 cal rounds and magazines.
- Fits both single & double stack mags of all manufacturers !
- One SKU. p/n 24222



BenchLoader™

Heavy Duty 30-round Loader (5.56)

(US patent 7,059,077)

- AR-15 / M-16 p/n 24225
- HK 416 / SA-80 & AR-15 / M-16 p/n 24226
- HK G36 p/n 24227
- Steyr AUG & AR-15 / M-16 p/n 24229
- Galil p/n 24228



maglula Ltd.

Watch video clips and read testimonials at www.maglula.com

Distributed by:  Tel: (913) 752-3400

© 2007 maglula Ltd., Israel

StripLULA™

M-16 /AR-15 stripper clip & loose rounds magazine loader



p/n 24200



Patents pending

- Stripper clip mag loader.
- Loose rounds mag loader.
- A simple unloader too.
- Does it all quickly and easily.
- 1/3 the size of competing loaders, and better !

UpLULA™

Universal Pistol Magazine Loader

Load them all:

- Beretta
 - Browning
 - Colt
 - CZ
 - FN
 - Glock
 - HK
 - Kimber
 - Para Ord.
 - Ruger
 - Sig / Sauer
 - S&W
 - Springfield Armory
 - STI Int.
 - Taurus
 - Walter
- and many more.



p/n 24222



World's #1 loaders!

Patents pending

- Loads all 9mm to .45 cal. rds. and mags.
- Fits both single and double-stack mags.
- Fits mags of all manufacturers.
- Easy and quick loading.
- Highly durable.
- One SKU.

LULA®

Magazine Loader & UnLoader



M16 / AR15 5.56 (.223) p/n 24215

AK47 / Galil 7.62 / 5.56 p/n 24216

M1A / M14 .308 p/n 24220

FN FAL .308 p/n 24221

COLT SMG 9mm p/n 24218

UZI 9mm p/n 24217

MP5 9mm p/n 24219

US pat. 6,810,616

maglula Ltd.

Watch video clips and
read testimonials at
www.maglula.com

Distributed by:  Tel:(913) 752-3400



© 2007-8 maglula Ltd.

Tools for Professionals !

StripLULA™

M16 | M4 5.56mm 10rd stripper clip & loose rounds mag. loader



U.S. patent 7,805,874

- Stripper clip mag loader.
- Loose rounds mag loader.
- A simple unloader too.
- Highly durable.
- Does it all quickly and easily.
- 1/3 the size of competing loaders.

UpLULA™

9mm to .45 universal pistol magazine loader

Load them all:

- Beretta
- Browning
- Colt
- CZ
- FN
- Glock
- HK
- Kimber
- Para Ord.
- Ruger
- Sig / Sauer
- S&W
- Springfield Armory
- STI Int.
- Taurus
- Walter
- and many more.



U.S. patents 7,503,138 and 7,637,048

- Loads all 9mm to .45 cal. magazines.
- Fits both single and double-stack mags.
- Fits mags of all manufacturers.
- Highly durable.
- Easy and quick loading.

LULA®

Magazine loader & unloader

- M16 | M4** 5.56 (.223)
- AK47 | Galil** 7.62 / 5.56
- M1A | M14** .308
- FN FAL** .308
- COLT SMG** 9mm
- UZI** 9mm
- MP5** 9mm



U.S. patent 6,810,616

maglula Ltd.

Video clips and product reviews at
www.maglula.com

© 2007-11 maglula Ltd.

Tools for Professionals !

Save time and pain at the range



UpLULA™

9mm to .45

Universal Pistol Loader

US distributor:



Tel: (913) 752-3400

maglula Ltd. Made in Israel
US patents 6,810,616 & 7,059,077
US & Intl. patents pending



AR-15 / M-16

LULA™

loader & unloader



AR-15 / M-16 BenchLoader™

Now shipping

Range BenchLoader™
Heavy-duty 30-round loader

for all metal & polymer 5.56/.223 AR15/M4 mags.

p/n BL71B **MSRP \$149**

New UpLULA™ colors

Beautiful, unique, & will stand out in a range bag

Lemon
p/n UP60L

OrangeBrown
p/n UP60BO

DarkGreen
p/n UP60DG



U.S. Pat. 7,059,077; Design Pat. D728,065 BenchLoader is a trademark of maglula Ltd.



Please contact your distributor

World's #1 loaders !

maglula Ltd.

Write No. 006 on Reader Service Card

serious airgun hunting starts here

The World's Most Powerful Production Air Rifle.

With the ability to launch .457 caliber projectiles at over 1000 fps and generating energy levels of over 500 foot pounds, the **Texan™** takes its place as the world's most powerful production air rifle. Easy to load and simple to use, this big bore air rifle will let you focus on hunting with the knowledge you have enough power to get the job done.

Texan shown with optional scope, bipod & rings.

For more information visit us online at www.airforceairguns.com or contact us today at 877-247-4867



AIRFORCE
AIRGUNS

Write No. 007 on Reader Service Card

THE VOICE OF THE INDEPENDENT RETAILER

SHOOTING SPORTS RETAILER

EDITORIAL

Editor- **Christian Lowe**
Group Managing Editor- **Hilary Dyer**
Digital Content Manager- **Scott Brown**

CREATIVE

Art Director- **Justin Lancaster**
Traffic Manager- **Scott Nesmith**

ADVERTISING

Group Publisher- **Jared Pfeifer**
Publisher- **Jonathan Edwards**
jrahnan@grandviewmedia.com • 205-408-3713
Advertising Sales Manager- **Don Harris**
Advertising Sales Rep- **Mike Kizzira**
Advertising Sales Rep- **Trey Crossno**
Outside Sales Reps- **Byers Media**

ADMINISTRATION

President- **Vicki Denmark**
Production Director- **Andy Estill**
Vice President-Publisher- **GVO- Derrick Nawrocki**
Chief Revenue Officer- **Chris Dolan**
Chief Marketing Officer- **Mary Beth Shaddix**
Marketing Director- **Annes Cooke**
Financial Director- **Randy Lyle**
Editorial Director- **Bob Robb**
VP Audience Development- **Delicia Poole**
Senior Audience Development Manager- **Ted Hannah**
New Business Development Director- **Stuart Anderson**
Audience Development Manager- **Anna Hicks**
Digital Audience Development Analyst- **Stacy Barnes**
Customer Service Manager- **Joe Kaloc**
Credit Manager- **Mortehsa Perkins**

ADVERTISING INFORMATION

Send advertising information to the Publisher(s)

SHOOTING SPORTS RETAILER®

ISSN 0887-9397, is published six times a year in January/February, March/April, May/June, July/August, September/October, and November/December, by Grand View Media Group. Published and owned by Grand View Media Group, 200 Craft Street, Suite 1, Birmingham, AL 35242. All rights reserved. Contents may not be printed or otherwise reproduced without written permission of Grand View Media Group. Grand View Media Group is not responsible for loss of queries, manuscripts, or other materials. The latter will not be returned unless accompanied by return postage.

Subscription: Free to qualifying retailers, wholesalers, manufacturers, and salespeople of shooting sports products within the U.S.; \$60 annually for all other US and Canadian subscribers; US and Canadian single copies - \$10; foreign single copies - \$15. For subscription and single copy orders, address changes, renewals, and adjustments, call toll-free 866-721-4807 or email ShootingSportsRetailer@h.aldata.com. Six weeks are required for entry of order and change of address.

POSTMASTER:

Send address changes to:
**SHOOTING SPORTS
RETAILER
SUBSCRIPTION DEPT.,
P.O. BOX 2174
SKOKIE, IL 60076**

Periodicals postage paid at Birmingham, AL 35242 and additional mailing offices.

GRAND VIEW MEDIA GROUP, SHOOTING SPORTS RETAILER

is a Member of
National Shooting Sports Foundation
Business Publications Audit of Circulation, Inc.

© Registered in the US Patent and Trademark Office. Copyright 2016 Grand View Media Group. All rights reserved. No part of this publication may be reproduced without written permission from the General Manager.

Grand View Media Group is not responsible for researching or investigating the accuracy of the contents of stories published in this magazine. Readers are advised that use of the information contained within this magazine is with the understanding that it is at their own risk. Grand View Media Group assumes no liability for this information or its use.

Grand View Media Group assumes no responsibility for unsolicited editorial, photography and art submissions. In addition, no Terms and Conditions agreements are recognized by Grand View Media Group unless signed and returned by the Editorial Director.



going through all the steps. It will be up to you to assist them. In fact, it's critical that you assist them. You might be the only safety instruction they receive. The only gun rule I didn't mention was knowing the target and what's beyond it. I would discuss that one later as we talk about caliber choice and the intended use of the gun.

The key to success is to come up with a way to do all of these things so that they appear natural rather than forced. I can foresee some people objecting to this process as cumbersome and time consuming, but I disagree. Learning to say things and demonstrate the behaviors correctly might take some time, but it takes no more time to explain as you're performing these actions than it does to do them without explanation. Trust me. It's something that I've been doing as an instructor for years. But even if it is going to take a little more time, the benefits far outweigh the additional minute you spend. **SSR**



↑ The chamber should always be cleared by both a visual and physical validation to ensure it is empty. Do it twice to be certain.

New!
UpLULA®
loader US-flag



p/n UP60US

US flag - Red-White-Blue



20Yrs
Celebrating 20 years
of maglula loaders
in the U.S.

New!
New counter-top
display holding 12
blistered UpLULA's
p/n PDQ12UP



U.S. Patented UpLULA is a registered trademark of maglula Ltd.
maglula.com

World's #1 selection of magazine loaders!
Professional pistol & rifle mag loaders Ask your distributor

Now shipping

Range BenchLoader™
Heavy-duty 30-round loader

for all metal & polymer 5.56/.223 AR15/M4 mags.

p/n BL71B **MSRP \$149**

New UpLULA™ colors

Beautiful, unique, & will stand out in a range bag

Lemon
p/n UP60L

OrangeBrown
p/n UP60BO

DarkGreen
p/n UP60DG



U.S. Pat. 7,059,077; Design Pat. D728,065 BenchLoader is a trademark of maglula Ltd.



Please contact your distributor

World's #1 loaders! **maglula Ltd.**

Write No. 006 on Reader Service Card

serious airgun hunting starts here

The World's Most Powerful Production Air Rifle.

With the ability to launch .457 caliber projectiles at over 1000 fps and generating energy levels of over 500 foot pounds, the **Texan™** takes its place as the world's most powerful production air rifle. Easy to load and simple to use, this big bore air rifle will let you focus on hunting with the knowledge you have enough power to get the job done.

Texan shown with optional scope, bipod & rings.

For more information visit us online at www.airforceairguns.com or contact us today at 877-247-4867



Write No. 007 on Reader Service Card

THE VOICE OF THE INDEPENDENT RETAILER

SHOOTING SPORTS RETAILER

EDITORIAL

Editor- **Christian Lowe**
Group Managing Editor- **Hilary Dyer**
Digital Content Manager- **Scott Brown**

CREATIVE

Art Director- **Justin Lancaster**
Traffic Manager- **Scott Nesmith**

ADVERTISING

Group Publisher- **Jared Pfeifer**
Publisher- **Jonathan Edwards**
jonathan@grandviewmedia.com • 205-408-3713
Advertising Sales Manager- **Don Harris**
Advertising Sales Rep- **Mike Kizire**
Advertising Sales Rep- **Trey Crossno**
Outside Sales Reps- **Byers Media**

ADMINISTRATION

President- **Vicki Denmark**
Production Director- **Andy Estill**
Vice President-Publisher, GVO- **Derrick Nawrocki**
Chief Revenue Officer- **Chris Dolan**
Chief Marketing Officer- **Mary Beth Shaddix**
Marketing Director- **Annee Cooke**
Financial Director- **Randy Lyle**
Editorial Director- **Bob Robb**
VP, Audience Development- **Delicia Poole**
Senior Audience Development Manager- **Ted Hannah**
New Business Development Director- **Stuart Anderson**
Audience Development Manager- **Anna Hicks**
Digital Audience Development Analyst- **Stacy Barnes**
Customer Service Manager- **Joe Kaloc**
Credit Manager- **Mortisha Perkins**

ADVERTISING INFORMATION

Send advertising information to the Publisher(s)

SHOOTING SPORTS RETAILER®

ISSN 0857-9397. Is published six times a year in January/February, March/April, May/June, July/August, September/October, and November/December, by Grand View Media Group. Published and owned by Grand View Media Group, 200 Croft Street, Suite 1, Birmingham, AL 35242. All rights reserved. Contents may not be printed or otherwise reproduced without written permission of Grand View Media Group. Grand View Media Group is not responsible for loss of queries, manuscripts, or other materials. The latter will not be returned unless accompanied by return postage.

Subscription: Free to qualifying retailers, wholesalers, manufacturers, and salespeople of shooting sports products within the U.S.: \$60 annually for all other US and Canadian subscribers; US and Canadian single copies - \$10; foreign single copies - \$15. For subscription and single copy orders, address changes, renewals, and adjustments, call toll-free 856-721-4807 or email ShootingSportsRetailer@halldata.com. Six weeks are required for entry of order and change of address.

POSTMASTER:

Send address changes to:

SHOOTING SPORTS RETAILER
SUBSCRIPTION DEPT.,
P.O. BOX 2174
SKOKIE, IL 60076

Periodicals postage paid at Birmingham, AL 35242 and additional mailing offices.

GRAND VIEW MEDIA GROUP, SHOOTING SPORTS RETAILER

is a Member of
National Shooting Sports Foundation
Business Publications Audit of Circulation, Inc.

© Registered in the US Patent and Trademark Office. Copyright 2016 Grand View Media Group. All rights reserved. No part of this publication may be reproduced without written permission from the General Manager.

Grand View Media Group is not responsible for researching or investigating the accuracy of the contents of stories published in this magazine. Readers are advised that use of the information contained within this magazine is with the understanding that it is at their own risk. Grand View Media Group assumes no liability for this information or its use.

Grand View Media Group assumes no responsibility for unsolicited editorial, photography and art submissions. In addition, no Terms and Conditions agreements are recognized by Grand View Media Group unless signed and returned by the Editorial Director.



remain consistent as the cylinder rotates and should not alter if the cylinder is pushed forward toward the barrel or pulled back toward the hammer. A slight movement (0.001-0.002 inches) is acceptable, but any more than that can indicate trouble.

The cylinder release should function easily. The yoke should open and close smoothly without binding. Once the cylinder is opened and swung out of the frame, it should rotate freely without any hitches or a feeling of graininess. The ejector rod in front of the cylinder should show no signs of wobble as the cylinder rotates, and it should show no marks or damage. When pushed to the rear, the ejector rod should again move smoothly and efficiently without binding. It should snap back briskly in place once the rod is released. The ejector at the rear of the cylinder and the rear face of the cylinder should have nice, sharp edges. Some cylinders may have a slight chamfer or beveled edge around the outer edge and each cylinder opening. These are normal and help with reloading as long as they are uniform.

The small gear at the rear of the ejector should be in great shape with no variation on any of its teeth.

Now it is time to move on to the most critical parts of the inspection: the action or working mechanisms of the gun. No doubt you've dry-fired the gun by this point (or even before you started your inspection). The trigger should have been smooth throughout its pull. The older the firearm is, the smoother it will likely be since actions tend to polish themselves over time. There should be no binding, and the trigger should snap easily back to the front when pressure is removed.

Next, cock the hammer to the rear in single-action mode and then push forward, trying to make it fall. It should remain firmly in the cocked position. Any issue here would make the gun unsafe.

The last step is to check the cylinder timing. It's another area that is critical for safety reasons. Work the action as if firing the gun and observe the cylinder closely. It should lock into place just before the gun fires. Once

locked, the cylinder shouldn't spin in either direction since it is supposed to be lined up with the barrel's bore. Check each chamber of the cylinder for consistency.

If these steps don't reveal any issues, you can be about 90% certain that the revolver will function properly and safely. **SSR**



† The fit and finish show no signs of damage or uneven gaps. The trigger is centered in the opening.

AR15 LULA®

5.56 / .223 mag loader & unloader

New!
DarkGreen



p/n LU10DG

UpLULA®

9mm - .45ACP universal
pistol magazine loader

**World's
#1
Loaders!**



p/n UP60B

Available colors
● Pink
● Green
● Orange
● Yellow
● Purple

Range BenchLoader®

Heavy-duty 30-round loader
5.56 / .223 AR15 / M4 mags



p/n BL71B

World's #1 selection of magazine loaders!
Professional pistol & rifle mag loaders

Ask your distributor

maglula Ltd.
maglula.com

U.S. Patented LULA and BenchLoader are registered trademarks of maglula Ltd.

to reduce recoil and shorten cycle time.

The Ruger PC Carbine magazine release and bolt charging handle is easily ambi-configurable in just a few minutes. Ruger did some serious design work to deliver the elegant simplicity of the magazine and bolt handle designs. My preference on the configuration was an AK/10/22 bolt charging location with the magazine release button on the right-hand side. I found this to be the fastest reload configuration. Of note, if you swap to a right-handed magazine release, old Gen 2 non-ambi Glock magazines will not work due to an absence of the ambi-latch notch on older magazines. The reach to the magazine release is not trigger-finger accessible, like on an AR-15, without releasing the grip. Sliding either the

support hand back and around the magwell to release the mag or sliding the firing hand up while shouldered is quick — not a high speed AR-15 reload process, but it works just fine.

Summing up the Ruger PC Carbine, it's a 10/22 that fires 9mm rounds. My FFI dealer and I were dying to shoot this. We walked to his back field and unloaded a few magazines containing a varied stack of handload and factory ammunition. My second group at about 15-yards was essentially all in the same ragged hole. Yes, the Ruger PC Carbine is accurate, not SUB-MOA 100-yard accuracy, but certainly hit the can at 100-yard accuracy. Based on my testing observations of the old PC9 versus the new version, the new PC Carbine is certainly proven itself much more accurate during additional testing.

For the suppressor owners, the nicely fluted barrel and factory threaded barrel deliver an excellent host for 9mm suppressors. My tests with Liberty Mystic X and Sig Sauer SRD9 suppressors were quiet and smile-inducing events especially with subsonic ammo.

Ruger has recreated the brutal simplicity of the 10/22 take-down model in the PC Carbine. Many customers have wished for a 10/22 that fired 9mm rounds from a Glock magazine or a PC9 that accepts Glock magazines, and now Ruger has delivered. In the hands of law enforcement officers or homeowner for defense or banging away on cans and steel for smiles, the utilitarian functionality and features of the new PC Carbine will make this one of the most attractive rifles in the Ruger line for 2018. **SS**

Shipping

SIG MPX™

9mm LULA™ magazine loader & unloader



p/n LU19B

SIG MPX is a trademark of SigSauer.

New

UpLULA™ colors - Purple, Lemon, Green, OrangeBrn



p/n UP60PR



p/n UP60L



p/n UP60DG



p/n UP60BO

Range

BenchLoader™

Heavy-duty 30-round loader

for all metal & polymer 5.56/.223 AR15 / M4 mags.



p/n BL71B

MSRP \$149

All products are patented and trademarked, owned by maglula Ltd., Israel

World's #1 magazine loaders !

maglula Ltd.

SHOOTING SPORTS RETAILER JUNE 2018

19

Range

MSRP \$149

BenchLoader™

Heavy-duty 30-round loader

for all metal & polymer 5.56/.223 AR15 / M4 mags.
p/n BL71B

Nov. 2016

SIG MPX™

9mm LULA™ magazine loader & unloader
p/n LU19B



New UpLULA™ colors - Purple, Lemon, Green, OrangeBrn



p/n UP60PR



p/n UP60L



p/n UP60DG



p/n UP60BO

U.S. Pat. 7,059,077; Design Pat. D728,065 BenchLoader is a trademark of maglula Ltd.
MPX is a trademark of SigSauer.

World's #1 loaders !

maglula Ltd.

THE VOICE OF THE INDEPENDENT RETAILER

SHOOTING SPORTS RETAILER

EDITORIAL

Editor- **Mark Ollis**
Group Managing Editor- **Hilary Dyer**
Associate Editor- **Brandon Miller**

CREATIVE

Art Director- **Justin Lancaster**
Traffic Manager- **Scott Nesmith**

ADVERTISING

Group Publisher- **Jared Pfeifer**
Senior Sales Executive- **Don Harris**
Senior Sales Executive- **Mike Kizzire**
Advertising Sales Rep- **Patrick Boyle**
Outside Sales Reps- **Byers Media**

ADMINISTRATION

Interim General Manager- **Mel Blackwell**
Production Director- **Andy Estill**
Vice President-Publisher, GVO- **Derrick Nawrocki**
Marketing Director- **Annee Cooke**
Financial Director- **Randy Lyle**
Audience Development Manager- **Anna Hicks**
Customer Service Manager- **Joe Kaloc**
Credit Manager- **Mortessa Perkins**

ADVERTISING INFORMATION

Send advertising information to the Publisher(s)

SHOOTING SPORTS RETAILER®

ISSN 0887-8397, is published six times a year in January/February, March/April, May/June, July/August, September/October, and November/December, by Grand View Media Group. Published and owned by Grand View Media Group, 200 Croft Street, Suite 1, Birmingham, AL 35242. All rights reserved. Contents may not be printed or otherwise reproduced without written permission of Grand View Media Group. Grand View Media Group is not responsible for loss of queries, manuscripts, or other materials. The latter will not be returned unless accompanied by return postage.

Subscription: Free to qualifying retailers, wholesalers, manufacturers, and end-users of shooting sports products within the U.S.; \$60 annually for all other US and Canadian subscribers; US and Canadian single copies - \$10; foreign single copies - \$15. For subscription and single copy orders, address changes, renewals, and adjustments, call toll-free 800-721-4807 or email ShootingSportsRetailer@halldata.com. Six weeks are required for entry of order and change of address.

POSTMASTER:

Send address changes to:
SHOOTING SPORTS RETAILER
SUBSCRIPTION DEPT.,
P.O. BOX 3138
NORTHBROOK, IL 60065-9877

Periodicals postage paid at Birmingham, AL 35242 and additional mailing offices.

GRAND VIEW MEDIA GROUP, SHOOTING SPORTS RETAILER

is a Member of:
National Shooting Sports Foundation
Business Publications Audit of Circulation, Inc.

© Registered in the US Patent and Trademark Office. Copyright 2017 Grand View Media Group. All rights reserved. No part of this publication may be reproduced without written permission from the General Manager.

Grand View Media Group is not responsible for researching or investigating the accuracy of the contents of stories published in this magazine. Readers are advised that use of the information contained within this magazine is with the understanding that it is at their own risk. Grand View Media Group assumes no liability for this information or its use.

Grand View Media Group assumes no responsibility for unsolicited editorial, photography and art submissions. In addition, no Terms and Conditions agreements are recognized by Grand View Media Group unless signed and returned by the Editorial Director.



WE'RE EASY TO HUNT DOWN



WEBSITE & STORE
grandviewoutdoors.com
grandviewoutdoors.com/sowd/sites



SOCIAL
facebook.com/grandviewoutdoors
twitter.com/gvoutdoors

GRAND VIEW
OUTDOORS

POWERED BY

archery
MAGAZINE

Bowhunting
MAGAZINE

AR
MAGAZINE

PREDATOR
MAGAZINE

Whitetail
MAGAZINE

Now shipping

Range BenchLoader™
Heavy-duty 30-round loader

for all metal & polymer 5.56/.223 AR15/M4 mags.

p/n BL71B **MSRP \$149**

New UpLULA™ colors

Beautiful, unique, & will stand out in a range bag

Lemon
p/n UP60L

OrangeBrown
p/n UP60BO

DarkGreen
p/n UP60DG



U.S. Pat. 7,059,077, Design Pat. D728,065 BenchLoader is a trademark of maglula Ltd.



Please contact your distributor

World's #1 loaders! **maglula Ltd.**

Write No. 006 on Reader Service Card

The Fully Adjustable Modular Buttstock Assembly

MBA-1 Rifle
\$139.95
*Weights only 18.4 oz

MBA-3 Carbine
\$159.95
*Weights only 19.2 oz

Adjustable Cheek Piece
Adjust Length of Pull
3-Axis Buttstock

Made in the USA **ORDER ONLINE: www.LUTH-AR.com**

Write No. 007 on Reader Service Card

THE VOICE OF THE INDEPENDENT RETAILER

SHOOTING SPORTS RETAILER®

EDITORIAL

Editorial Director- **Bob Robb**
Group Managing Editor- **Hilary Dyer**
Editor- **Mark Ollis**
Associate Editor- **Brandon Miller**

CREATIVE

Art Director- **Justin Lancaster**
Traffic Manager- **Scott Nesmith**

ADVERTISING

Group Publisher- **Jared Pfeiffer**
Publisher- **Jonathan Edwards**
Advertising Sales Manager- **Don Harris**
Advertising Sales Rep- **Mike Kitzire**
Advertising Sales Rep- **Trey Crossno**
Outside Sales Reps- **Byers Media**

ADMINISTRATION

President- **Vicki Denmark**
Production Director- **Andy Estill**
Vice President/Publisher, GVO- **Derrick Nawrocki**
Chief Revenue Officer- **Chris Dolan**
Chief Marketing Officer- **Mary Beth Shaddix**
Marketing Director- **Anne Cooke**
Financial Director- **Randy Lyle**
VP Audience Development- **Delicia Poole**
New Business Development Director- **Stuart Anderson**
Audience Development Manager- **Anna Hicks**
Digital Audience Development Analyst- **Stacy Barnes**
Customer Service Manager- **Joe Kaloc**
Credit Manager- **Mortasha Perkins**

ADVERTISING INFORMATION

Send advertising information to the Publisher(s)

SHOOTING SPORTS RETAILER®

ISSN 0897-8087. Is published six times a year in January/February, March/April, May/June, July/August, September/October, and November/December by Grand View Media Group. Published and owned by Grand View Media Group, 2001 Craft Street, Suite 7, Birmingham, AL 35242. All rights reserved. Contents may not be printed or otherwise reproduced without written permission of Grand View Media Group. Grand View Media Group is not responsible for loss of queries, manuscripts, or other materials. The latter will not be returned unless accompanied by return postage.

Subscription: Free to qualifying retailers, wholesalers, manufacturer and wholesaler of shooting sports products within the U.S.; \$60 annually for all other US and Canadian subscriptions; US and Canada single copies - \$10, foreign single copies - \$15. For subscription and single copy orders, address changes, renewals, and adjustments, call toll-free 888-721-4907 or email ShootingSportsRetailer@lithdata.com. Six weeks are required for entry of order and change of address.

POSTMASTER:

Send address changes to:
SHOOTING SPORTS RETAILER
SUBSCRIPTION DEPT.,
P.O. BOX 2174
SKOKIE, IL 60076

Periodic postage paid at Birmingham, AL 35242 and additional mailing offices.

GRAND VIEW MEDIA GROUP, SHOOTING SPORTS RETAILER

is a Member of
National Shooting Sports Foundation
Business Publications Audit of Circulation, Inc.

© Registered in the US Patent and Trademark Office. Copyright 2016 Grand View Media Group. All rights reserved. No part of this publication may be reproduced without written permission from the General Manager.

Grand View Media Group is not responsible for researching or investigating the accuracy of the contents of stories published in this magazine. Readers are advised that use of the information contained within this magazine is with the understanding that it is at their own risk. Grand View Media Group assumes no liability for this information or its use.

Grand View Media Group assumes no responsibility for unsolicited editorial, photography and art submissions. In addition, no Terms and Conditions agreements are recognized by Grand View Media Group unless signed and returned by the Editorial Director.



IN FOCUS

and up for safe.

Built in .32 ACP, .380 ACP and .22 LR, numeric designations include 70, along with "S" and "I" versions, model numbers 71-75 and 101 as well as the names "Cougar," "Jaguar," "New Jaguar" and "Puma." Supposedly, the Jaguar version is capable of being fired in either .22 LR or Short with a simple change of recoil springs, although the blocked .22 Short M70 magazine we found for sale on www.gunbroker.com suggests the caliber change might have been a bit more involved.

We compared the test gun to a steel-framed Model 70S in .380 ACP and found several minor differences, including the takedown procedure. While the M71 barrel is removed from the bottom

of the slide, the .380 barrel comes out of the top. The magazine safety found on the 70S but not the M71, as well as the markings for the takedown lever (English on the 70S, Italian on the M71), can likely be attributed to being made for U.S. export.

Interestingly, we found both barrels would fit and lock in place interchangeably on the two frames, and the slides would start but wouldn't go to battery because of the interference by the different-sized ejectors. This offers possibilities for those interested in multi-caliber pistols.

Of all the barrel length and caliber options, the .22 made the greatest impact, and it did not do so in Italian hands. Surprisingly accurate and reputed to be one of (if not the) most reliable

.22 pistols ever made, the 70 series .22s were attractive to the Israeli Mossad (reportedly as assassination tools) and their air marshals, who supposedly chose the .22 for the limited damage it would do to an airplane.

Opinions differ as to how much of this is true and how much is myth. Nonetheless, it's part of the gun's mystique and has an appeal for many purchasers.

A compromise required to make the M71 importable, the permanent addition of a fake suppressor adds enough barrel length to raise the pistol's point score for import. The fake suppressor consists of a solid piece of steel with a hole drilled through it to allow the bullet to pass, and two different sections of knurling. Unfortunately, it weighs 16 ounces by itself compared to 17 ounces

Ammo shortage ?

We apologize

UpLULA™
p/n UP60B

LULA™
p/n LU10B

StripLULA™
p/n SL50B

XT-LULA™
p/n XT83B

Range BenchLoader™
p/n BL71B

World's #1 mag loaders !

maglula

www.maglula.com

No more pain !

New!

Write No. 019 on Reader Service Card

Now shipping

Range BenchLoader™
Heavy-duty 30-round loader

for all metal & polymer 5.56/.223 AR15/M4 mags.

p/n BL71B **MSRP \$149**

New UpLULA™ colors

Beautiful, unique, & will stand out in a range bag

Lemon
p/n UP60L

OrangeBrown
p/n UP60BO

DarkGreen
p/n UP60DG



Please contact your distributor

World's #1 loaders !

maglula Ltd.

Write No. 006 on Reader Service Card

THE VOICE OF THE INDEPENDENT RETAILER

SHOOTING SPORTS RETAILER

EDITORIAL

Editorial Director- **Bob Robb**
Group Managing Editor- **Hilary Dyer**
Digital Content Manager- **Scott Brown**

CREATIVE

Art Director- **Justin Lancaster**
Traffic Manager- **Scott Nesmith**

ADVERTISING

Group Publisher- **Jared Pfeiffer**
Publisher- **Jonathan Edwards**
jedd@shooting-sportsretailer.com • 205-410-0716
Advertising Sales Manager- **Don Harris**
Advertising Sales Rep- **Mike Kizore**
Advertising Sales Rep- **Trey Crossno**
Outside Sales Reps- **Byers Media**

ADMINISTRATION

President- **Vicki Denmark**
Production Director- **Andy Estill**
Vice President-Publisher, CVO- **Derrick Nawrocki**
Chief Revenue Officer- **Chris Dolan**
Chief Marketing Officer- **Mary Beth Shaddix**
Marketing Director- **Annee Cooke**
Financial Director- **Randy Lyle**
VP Audience Development- **Delicia Poole**
New Business Development Director- **Stuart Anderson**
Audience Development Manager- **Anna Hicks**
Digital Audience Development Analyst- **Stacy Barnes**
Customer Service Manager- **Joe Kaloc**
Credit Manager- **Mortehsa Perkins**

ADVERTISING INFORMATION

Send advertising information to the Publisher(s)

SHOOTING SPORTS RETAILER®

ISSN 0007-9097. Is published six times a year in January/February, March/April, May/June, July/August, September/October, and November/December, by Grand View Media Group. Published and owned by Grand View Media Group, 200 Crull Street, Suite 1, Birmingham, AL 35242. All rights reserved. Contents may not be printed or otherwise reproduced without written permission of Grand View Media Group. Grand View Media Group is not responsible for loss of queries, manuscripts, or other materials. The latter will not be returned unless accompanied by return postage.

Subscription: Free to qualifying retailers, wholesalers, manufacturers, and subscription to shooting sports products within the U.S. \$90 annually for all other US and Canadian subscribers; US and Canada: single copies - \$10; foreign single copies - \$15. For subscription and single copy orders, address change, renewals and adjustments, call toll-free 086-721-4807 or email shooting@sportsretailer.com. \$16.95 issues are required for entry of order and change of address.

POSTMASTER:

Send address changes to:

SHOOTING SPORTS

RETAILER

SUBSCRIPTION DEPT.,

P. O. BOX 2174

SKOKIE, IL 60076

Postoffice postage paid at Birmingham, AL 35242 and additional mailing offices

GRAND VIEW MEDIA GROUP, SHOOTING SPORTS RETAILER

is a Member of:

National Shooting Sports Foundation

Business Publications Audit of Circulation, Inc.

© Registered in the US Patent and Trademark Office. Copyright 2016 Grand View Media Group. All rights reserved. No part of this publication may be reproduced without written permission from the General Manager.

Grand View Media Group is not responsible for researching or investigating the accuracy of the contents of stories published in this magazine. Readers are advised that use of the information contained within this magazine is with the understanding that it is at their own risk. Grand View Media Group assumes no liability for this information or its use.

Grand View Media Group assumes no responsibility for unsolicited editorial, photography and art submissions. In addition, no Terms and Conditions agreements are recognized by Grand View Media Group unless signed and returned by the Editorial Director.



LUTH-AR The **NEW** Fully Adjustable Buttstock for AR's
MADE IN THE USA

Now Available In **FDE & Pink**

The "MBA" \$139.95
Modular Buttstock Assembly "MBA-1" / 7.2 lbs

The Skullton \$49.95
"MBA-2" / 7 lbs

Order Online: **WWW.LUTH-AR.COM**

Write No. 007 on Reader Service Card

UpLULA®

9mm - .45ACP universal
pistol magazine loader
& unloader



UP60B

Available colors



- Fits single & double-stack mags
- Painless loading & unloading
- Highly reliable, lightweight
- Works like a champ, for years!

AR15 LULA®

5.56 / .223 loader & unloader



LU10DG

**World's best selling
magazine loaders!**

Over thirty professional pistol & rifle
mag loaders - Made in Israel

Ask your local dealer

maglula Ltd.
Since 2001

maglula.com

THE KEEFE REPORT

Up to March 29, 1911, the official military hand arm of the United States was the Colt's .38 caliber revolver. But on that day, as a result of the movement of powerful forces too strong to be resisted and which have been acting for very long, that good old revolver became obsolete and in its stead there was marked for the holsters of this Nation's defenders the .45 Colt's automatic; the latest, the most deadly, the finest and the best hand arm which had yet to be produced by man."

Those words are from an April 6, 1911, article in these pages entitled, "The Greatest Pistol In The World." For the vast majority of its existence, the U.S. Model of 1911, followed by the M1911A1—or the commercial Government Model—was synonymous with "forty-five." If you said that or wrote ".45," everyone knew not only what cartridge you were talking about, but what gun as well.

That said, there have been exceptions, including guns in .455 Webley produced for the British during World War I, and then in 1928 Colt introduced the Super .38, chambered, of course, in .38 Super. Colt touted the Super .38 as, "For the big game hunter and the lover of the outdoors, the Super .38 offers an arm of unsurpassed power and efficiency ... Will stop any animal on the American Continent and is a favorite as an auxiliary arm for big game hunting trips." The gun went rimfire in 1931 with the .22 Long Rifle Ace. There have been others, including the .38 AMU, .30 Luger and even 9 mm Steyr, but none challenged the .45 ACP for supremacy.

But the dominance of the .45 ACP M1911 has been chipped away at in more recent years. Our cover gun this month is a Kimber Rapide Black Ice chambered in 10 mm Auto, and you can find the story written by Field Editor B. Gil Horman starting on p. 44. If any pistol cartridge can live up to the promise of Colt's above-mentioned marketing hype, it's the 10 mm. The weight of an all-steel M1911 with a full 5" barrel makes the recoil of a full-power 10 mm loads if not quite pleasant, then certainly manageable.

The bigger story today, though,



is the M1911 platform chambered in 9 mm Luger, particularly in the 4 1/4"-barreled Commander size. The aluminum-frame Commander in 9 mm made its way into Colt's catalog in 1950 where it sat alone until other makers began offering them starting in the 1980s. The popularization of the 9 mm cartridge in the Commander-size M1911 had to wait for improvement in defensive 9 mm Luger ammunition, which is a more recent development.

There is a very well-written and well-reasoned story by Field Editor Justin Dyal about the "The Rise Of The 9 mm M1911" on p. 58. Adopted by the German army for the Luger pistol in 1908, the 9 mm Parabellum, or 9 mm Luger, is perhaps more of an American cartridge than a German one today. In terms of all guns currently produced, those in 9 mm Luger far outstrip those in .45 ACP.

In the upper right-hand corner of this month's cover is a Colt Lightweight Commander built to Field Editor Wiley Clapp's specifications. Included are stocks of Wiley's own design that bear a Germanic "9." During World War I, the Germans issued the Mauser Broomhandle chambered in 9 mm Luger with wooden stocks engraved with a "9" and filled in with red paint to indicate they were not chambered for the .30 Mauser. Intended as an historical homage, it may well be indicative of a turning point in M1911s.

Sincerely,

Mark A. Keefe, III



Celebrating 20 years of
maglula loaders in U.S.

US flag
UpLULA®
9mm - .45ACP universal
pistol magazine loader
& unloader - RWB



UP60US

Other available colors



- Fits single & double-stack mags
- Painless loading & unloading
- Highly reliable, lightweight
- Works like a champ, for years!

**World's best selling
magazine loaders!**

Over thirty professional pistol & rifle
mag loaders - Made in Israel

Ask your local dealer

maglula Ltd.
Since 2001

8

THE RIFLEMAN REPORT

The familiar phrase, "good things come in small packages," is fully borne out in this month's issue through examples from several firearm industry giants.

First is the subject of the cover story, Kimber's new micro-compact R7 Mako handgun. Yes, it is yet another entrant into the crowded waters of striker-fired, polymer-frame semi-automatics that seem to have flooded the market in recent years, but this one boasts several notable features that serve to strengthen the mystique with which the Kimber name is imbued. The task of telling the Mako's story fell to the capable hands of Executive Editor Evan Brune, who has evaluated more than his fair share of modern carry guns, and his report, "Kimber's R7 Mako: Into The Shark Tank," begins on p. 44.

Yet another example of exploiting the concept of compactness is found in the recently released line of Mossberg 590S pump-actions, designed specifically to handle Federal's Shorty and Aguila's Mini shotshells and boasting onboard capacities of up to 14 rounds. Field Editor B. Gil Horman had an opportunity to put both shoulder-stock and birdshead-grip models of the 590S through their paces at Gunsite Academy in Paulden, Ariz., and recounts his findings in the story "Mossberg's 590S Short-Shell Specialist" starting on p. 50.

And in perhaps the textbook example of physical stature being inversely proportional to success in the marketplace, the .17 HMR cartridge celebrates its 20th anniversary this year, so Field Editor John Haviland, who has spent considerable time shooting it, got together with representatives from Hornady, the company that created the rimfire sensation, to delve into its backstory. His report on "The Little Cartridge That Could"—first chronicled in our March 2002 issue—is titled "20 Years With The .17 Hornady Magnum Rimfire" and starts on p. 56.

Finally, though not directly product-related, another powerful example of the potency of brevity can be found in our very language. As word counts in English writing go, 27 would seem a rather small number—the entire

The Story of...
The Little Cartridge That Could

The .17 Hornady
Magnum
Rimfire



American
Rifleman

language contains more than 171,000 after all—but, in the context of the U.S. Constitution, it was deemed sufficient to codify an enormously important concept: our country's unique Second Amendment. Those 27 words are no less than the definitive basis on which the unalienable right to the defense of true individual liberty rests. They read: "A well regulated militia, being necessary to the security of a free state, the right of the people to keep and bear arms, shall not be infringed."

As a double major in English and journalism from James Madison University—named for the Constitution's author and, at 5' 4", its our shortest president—I find it difficult not to zero-in on that last word, "infringed." A quick check of Merriam-Webster's offers this definition: "To encroach upon in a way that violates law or the rights of another." Further, it defines "encroach" as: "to enter by gradual steps or by stealth into the possessions or rights of another." Small steps and deception are certainly typical of the methodology employed by leftist forces to win major ideological victories, and the anti-gun movement has done exactly that for many years. That is why all patriotic Americans must resolve to retain, assert and celebrate our constitutionally recognized right to firearm ownership.

I hope we can continue to enjoy new products that magnify the power of compactness such as those covered in this issue. Moreover, I pray that we vigilantly guard against any further infringement against the freedom expressed in those precious few words of our uniquely American birthright—the monumentally important Second Amendment.

—BRIAN C. SHIETZ, EDITOR IN CHIEF

UpLULA™

9mm to .45ACP universal
pistol mag loader

Over 16,000 5-star reviews online!



Loads all mags:
Glock, SIG, HK, FN
Beretta, Colt, CZ,
Ruger, S&W, Walther,
Kimber, STI, etc...

p/n UP60B



Available in six colors

**World's best selling
magazine loaders!**

Over thirty professional pistol & rifle
mag loaders - Made in Israel

Ask your local dealer

maglula Ltd.
Since 2001

All products are patented and trademarked by Maglula Ltd, Israel

maglula.com

THE KEEFE REPORT

Remain calm. Odds are you have heard Vista Outdoor is putting Savage Arms on the block. And it may, but there is quite a lot more to it, and it cannot be fully explained in a pithy meme or in 140 characters. On May 1, "Vista Outdoor Inc. ... announced its strategic business transformation plan, designed to allow the company to focus resources on pursuing growth in its core product categories." And top Vista executives were on the phone right away with us.

To be clear, this was not a knee-jerk reaction to a moveon.org Astroturf petition drive and not "in light of recent events," as "The plan is a result of a comprehensive strategic review, which began in November 2017." And it's not just Savage.

"Our review identified product categories that are core to the company's long-term business strategy," said Vista Outdoor Chief Executive Officer Chris Metz. "We believe future investment should focus on categories where Vista Outdoor can achieve sustainable growth, maximize operational efficiencies, deliver leadership economics and drive shareholder value."

"As a result of this evaluation, and with support from its board of directors, Vista Outdoor will focus on achieving growth through its market-leading brands in ammunition, hunting and shooting accessories, hydration bottles and packs, and outdoor cooking products."

"The company plans to explore strategic options for assets that fall outside of these product categories, including its remaining Sports Protection brands (e.g. Bell, Giro and Blackburn), Jimmy Styks paddle boards, and Savage and Stevens firearms."

If you doubt Vista's commitment to the shooting sports, you need to have a look at what companies are not becoming a "strategic option." Vista Outdoor has no fewer than 50 brands, and it is choosing to focus, for solid business reasons, on what it calls its core businesses.

Vista, at heart, is an ammunition and accessory company, and the brands, among others, Vista will



focus on are Federal Premium, CCI, Speer, Blazer, Estate Cartridge, Fusion, American Eagle and Force N Force. Then on the optics and accessories side, there are Bushnell, Weaver, Simmons, Millett, Tasco, Night Optics, Primos, Blackhawk!, RCBS, Champion Range And Target, Butler Creek, Uncle Mikes, Eagle, Hoppes No. 9, Gunslick Pro, Outers and Alliant Powder. This is not a company running from NRA members and the shooting sports. It's one that is trying to compete and succeed in a tough market.

So why is this happening? "Vista Outdoor expects that the execution of this process will significantly reduce the company's leverage, improve financial flexibility and the efficiency of its capital structure, and provide additional resources to reinvest in core product categories, both organically and through acquisition."

This is not an example of the corporate cowardice that we have seen from companies that are not committed to the shooting sports. No, when you look at the Vista portfolio, even with this "strategic transformation plan," there a lot of shooting sports names there—and I expect they will emerge stronger.

Top management assures us that CEO Chris Metz is "committed to the shooting sports but needs to drive shareholder value." Savage would have required investment to become a full line in the firearms segment.

The sale of these brands is not a done deal, and it is not happening overnight. While I know nothing about the bicycle helmet business, I can say that Savage, unlike some companies out there, is actually worth buying.

Sincerely,

Mark A. Keefe, III



Celebrating 20 years of
maglula loaders in U.S.

US flag
UpLULA®
9mm - .45ACP universal
pistol magazine loader
& unloader - RWB



UP60US

Other available colors:



- Fits single & double-stack mags
- Painless loading & unloading
- Highly reliable, lightweight
- Works like a champ, for years!

**World's best selling
magazine loaders!**

Over thirty professional pistol & rifle
mag loaders - Made in Israel

Ask your local dealer

maglula Ltd.
Since 2001

RIFLEMAN REPORT

It seems that nearly every month we hear of increasing numbers of Americans who, motivated by domestic and international circumstances, are taking steps to embrace their individual right to keep and bear arms. It is surely a positive trend, and one that bodes well for the long-term viability of our republic. At the same time, however, we are reminded that people in many other countries are still denied fundamental human rights and are suffering under the oppression of socialism or communism.

One significant aspect of that positive news about domestic gun ownership is that the ranks of female shooters in the United States continue to grow. In fact, more than one third of the 5.4 million first-time gun buyers last year were women, according to industry sources. As a result, several companies have taken notice, and some have decided to produce products designed specifically to address the needs of female shooters. One such firm is the famed German gunmaker Walthers, which was founded in 1886, and today serves its U.S. customers from a manufacturing facility in Arkansas. In "Walthers PDP F-Series: A Win For Women" starting on p. 38, *NRAWomen.com* Editor in Chief Ann Smith describes how the company's new F-Series pistols have ergonomic and mechanical features that have been designed specifically with women in mind. In fact, they were developed with input from female shooters and engineers. Her story includes a full technical review sidebar by Editorial Director Mark A. Keefe, IV, whose years of experience in firearm evaluation lend even more insight.

On an entirely different note, we look back a bit to a unique example of American ingenuity—the kind that can spring forth from the private sector when a free society breeds levels of success and wealth that allow creative minds to indulge in experimentation. In "Holland & Holland's Mighty .700 Nitro Express" on p. 46, contributor Joe Coogan chronicles the creation of one of the world's most powerful sporting cartridges—the .700 Nitro Express—which was the brainchild of Beverly Hills businessman William Feldstein.



NRA photo

As to that aforementioned negative point, we learn that amid Russia's relentless, barbaric attacks on the sovereign Eastern European nation of Ukraine, combatants on both sides of the conflict include individuals armed with specialized sniper rifles. Fortunately, as some observers have noted, those fighting for Ukraine—including at least one woman—appear to be more adept in their tradecraft. To lay out the situation in detail, we enlisted the expertise of sniping authority and *American Rifleman* contributor John Plaster who reports on the guns, ammunition and training in that war in "Sniping In Ukraine" beginning on p. 52. It's also worth noting that America's firearm industry hasn't sat still during the months-long war, augmenting U.S. military aid to Ukraine with guns, optics and ammunition as reported in the Opening Shot on p. 26. Those efforts are helping to stave off the Russian war machine, even as some speculate that the conflict could ignite a third world war.

Of course, there is plenty more content within the pages of this issue of *American Rifleman* regarding the latest in firearms and related gear, along with reloading tips and historical information. It's all part of a rich heritage of individual liberty that has helped establish a standard of living and a quality of life unrivaled across the globe. As has always been the case, however, guarding such freedom requires constant vigilance and resolve—not just on the part of nation states, but in the hearts of the people themselves.

Nowhere is that truth better demonstrated than in America.

—BRIAN C. SHEETZ, EDITOR IN CHIEF

#1



UP60B

UpLULA®

9mm - .45ACP universal
pistol magazine loader
& unloader



**World's best selling
magazine loaders!**

Over thirty professional pistol & rifle
mag loaders - Made in Israel

Ask your local dealer

maglula Ltd.
Since 2001

THE RIFLEMAN REPORT



Although we will continue to celebrate the 100th anniversary of *American Rifleman* throughout this year, the collectible issue now in your hands marks the official commemoration of our centenary (p. 46). You'll find it full of glimpses back into the history of your NRA and the firearms and gear—along with the people who invented, manufactured and employed them for noble, life-saving purposes—covered herein during the past 10 decades.

You're likely to notice the nameplate on the cover of this issue. It is the same one used in 1923, refreshed by Senior Art Director David Labrozzi, a talented artist who has been responsible for the brand design and creative direction of this magazine for the past 27 years.

Then there is the story, "A Century Of Service: *American Rifleman* Turns 100" beginning on p. 46 by my predecessor, Mark A. Keefe, IV, who was editor in chief for 24 years before I took over that role two years ago. As for my own time on this staff, it has now been a bit more than 25 years, and during that period I've worked with a wide variety of capable staffers. Those with whom I am privileged to serve today—Senior Executive Editor Kelly Young, Executive Editor Evan Brune, Managing Editor Christopher Olsen, Senior Editorial Assistant Maureen Denfeld and Senior Photographer Forrest MacCormack—are among the finest ever, with a combined total service of more than 40 years. Each month, they help me ensure that *American Rifleman* is held to the same high standard on which it was founded a century ago.

All of that staff experience adds up to a considerable amount of institutional knowledge and subject-matter expertise. Of course, we wouldn't be able to produce the magazine were it not for the work of the field and contributing editors listed on the masthead (p. 4). Each of us—along with you, the NRA member—is committed to the cause of a freedom that can and must be defended, every day, by our nation's oldest civil-rights organization.

And though we value looking back and appreciating history, we also realize that as "The World's Oldest And

Largest Firearm Authority," we have just as much responsibility to the present and the future of firearm coverage. Indeed, with a greater readership, by far, than any other gun magazine, we strive for a mix of content that integrates the old, the current and the coming trends so that we can fully understand how firearms have influenced history and preserved liberty.

In this month's "Classy Companion: Henry's Homesteader 9 mm PCC" (p. 56), Field Editor B. Gil Horman takes a look at a new twist on the pistol-caliber carbine—one that is as pleasing to the eye as it is on the shoulder. Henry has done a remarkable job in bringing highly desirable lever-actions and other designs to market that feature exemplary fit and finish. This time, the platform is different, but the high quality and distinctive style remain.

In "FN Reflex: A Micro-Compact For The Masses" (p. 64), author Brune had the chance to run the new pistol hard at an event in which it proved itself both reliable and remarkably accurate. It is yet another sign of the times in which eminently capable pistols of convenient size are, in some circles at least, as ubiquitous as cellphones.

The M1 Garand is, by now, well-known to most readers as a result of its stellar service throughout all theaters of World War II and the Korean War. And while its detractors are few and far between, it has, on occasion, been criticized for its weight and its feed mechanism. In "The En Bloc Clip: Don't Blame John Garand" (p. 70) Field Editor Bruce N. Canfield, who knows a thing or two about Garand's masterpiece, explains how the inventor's original intention was not to use the now-familiar en bloc clip.

We hope that as you peruse this issue, you'll be reminded that only you can ensure that NRA remains strong in an increasingly uncertain world and that our uniquely American right to keep and bear arms—the key to genuine individual liberty—is preserved well into the future.

Thanks for celebrating our past century of service to you—it's been a fascinating journey and our honor.

Here's to 100 more!

—BRIAN C. SHEETZ, EDITOR IN CHIEF

UpLULA®

9mm - .45ACP universal
pistol magazine loader
& unloader



UP60B

Available colors



- Fits single & double-stack mags
- Painless loading & unloading
- Highly reliable, lightweight
- Works like a champ, for years!



Over 16,000 five-star reviews online

**World's best selling
magazine loaders!**

Over thirty professional pistol & rifle
mag loaders - Made in Israel

Ask your local dealer

maglula Ltd.
Since 2001

maglula.com

THE KEEFE REPORT

The process for bringing a new editor onto the staff of *American Rifleman* usually involves reviewing previous written work, various tests of editing skill and firearm knowledge, then, of course, interviews. The latter cannot always be done in person, so we found ourselves interrogating a prospective associate editor in Texas via Skype. Toward the end, my colleague Brian Sheetz asked then-candidate Kelly Young, "What's your favorite gun?" Kelly's reply came via fishing around below the camera's view and pulling out a Fabrique Nationale PS90, chambered for the 5.7x28 mm FN cartridge. Kelly didn't know that his choice of carbine—he's unrepentantly left-handed, by the way—told us a lot about him. Enough so that, combined with his skill set, within a month he had a job offer.

That was five years ago, and now Managing Editor Kelly Young has two features in this issue alone. One is on the new Ruger-57 pistol (p. 36), the first major introduction of a firearm chambered for the 5.7x28 mm FN in more than a decade. Until this time the only handgun available has been the innovative FN Five-seveN pistol, now in its Mk2 configuration, (americanrifleman.org/fnmk2). Its design, which features metal slide components encased in polymer, no external frame rails and a T-shaped rail running through the top center of the polymer receiver, is unusual to say the least, and its unusual lines and a safety located on the frame above the trigger are somewhat dated.

As Kelly ably describes in his story, there's been much "chicken or egg" discussion about the 5.7 mm cartridge. The military SS1019 ammunition is not available to civilians in the United States, and while there are a small number of loads including those from FN, Fiocchi and an American Eagle FMJ, there have been few guns. They include those from FN, the AR-57 and the CMMG Banshee (for more on the latter and other CMMG guns, see Kelly Young's other story beginning on p. 50).

But now Speer has changed the dynamics for owners of guns



chambered in 5.7 mm—including the Ruger-57. One of the top personal-protection ammunition lines in the country is Speer's Gold Dot, and it now includes a 40-gr. jacketed hollow point in 5.7 mm. Out of the Ruger-57's 4.9" barrel, the 40-gr. Gold Dot had a velocity of 1790 f.p.s., delivering 285 ft.-lbs. of energy. Out of a very similar length barrel (4.86"), Federal's 9 mm Luger Hydra-Shok 124-gr. JHP moves out at 1063 f.p.s., delivering 311 ft.-lbs.

Few doubt the efficacy of the 9 mm these days as a defensive cartridge, but some find it too much in the way of perceived recoil. In a December 1999 article, author Dan Shea pointed out the 5.7 mm's recoil impulse was about 70 percent less than that of the 9x19 mm NATO: the energy doesn't go away, obviously, the pistol (in the article an FN Five-seveN) just has a different recoil impulse. Those with a sensitivity to recoil may want to give the 5.7x28 mm FN a look as there is now a serious defensive loading available.

That's something the 5.7x28 mm FN has not had a lot of recently—looks—let alone a second chance. I, for one, never thought this little cartridge received a fair shake. In the early 2000s I lobbied FN management to add a bull-barreled bolt-action chambered in 5.7x28 mm FN to its SPR line. It seemed to me the little cartridge would make for a great varmint and predator gun. My pleas, perhaps rightly, fell on deaf ears.

Judging from the initial response, Ruger has a winner with this platform. And I suspect other gun companies will follow with new models of 5.7x28 mm FN pistols and carbines, leading to far greater acceptance of this interesting little cartridge. Who knows, maybe I'll finally get that bolt gun after all.

Sincerely,

Mark A. Keefe, III



Celebrating 20 years of maglula loaders in U.S.

US flag
UpLULA[®]
9mm - .45ACP universal
pistol magazine loader
& unloader - RWB



UP60US

Other available colors



- Fits single & double-stack mags
- Painless loading & unloading
- Highly reliable, lightweight
- Works like a champ, for years!

**World's best selling
magazine loaders!**

Over thirty professional pistol & rifle
mag loaders - Made in Israel

Ask your local dealer

maglula Ltd.
Since 2001

8

THE RIFLEMAN REPORT

Choice is an essential part of any healthy relationship. As Americans, we are free to select our mates, determine the size of our families, decide where and how to live, settle on our vocations, vote for our governmental representatives and buy the material goods that suit our needs and desires. Within that last category exist more than 7,400 print consumer magazines, and the one you hold in your hands has recently been ranked as high as 19th among them in terms of its circulation. That's a powerful statement as to the choice that Americans continue to make regarding the importance of firearms, optics, ammunition and related gun accessories in their lives.

Each month, *American Rifleman* testifies to the breadth of choice that Americans have when it comes to guns for self-defense or sporting pursuits, and this issue is no exception. It begins with the corporate choice that publicly traded Sturm, Ruger & Co.—started in 1949 as a partnership between Alexander Sturm and Bill Ruger to build an inexpensive rimfire pistol—made to acquire the storied Marlin brand, which is now more than a century-and-a-half old. Editor Emeritus John Zent, Senior Executive Editor Kelly Young and Executive Editor Evan Brune explore that significant development through: "Marlin Reborn: Ruger Resurrects A Legend" on p. 40, "In The Field And On The Range With Mayodan Marlins" on p. 46, and "Opening Shot" on p. 26, respectively. Choice in firearms these days includes deciding not just on brand but on country of origin. In his test of the new Canik METE SFX, Field Editor B. Gil Horman examines the ins and outs of the latest model from Turkish manufacturer Samsun as imported by the familiar U.S. firm of Century Arms—which has been offering Americans a wide variety of choice in military surplus arms since its founding in 1961.

For those who appreciate classic guns from the heyday of Connecticut Valley gunmaking, we have a first-hand report by Field Editor Justin Dyal titled "A First-Year Magnum: Shooting The S&W Pre-29" starting on p. 56. And,



The first issue of The American Rifleman, 1923

as always, even more choices fill this month's "Dope Bag"—our longstanding department dedicated to laying out expert "Data & Comment" relevant to all sorts of new rifles, shotguns, handguns, optics and accessories. This month, beginning on p. 62, we evaluate an Officer-size M1911 pistol, an Eastern Bloc-pattern sniper rifle and an electronic training aid.

Our entire staff consists of committed firearm enthusiasts and Second Amendment advocates who choose to work hard every month to deliver NRA members the pre-eminent magazine in the marketplace for informative, entertaining coverage of firearms and related gear—a tradition that dates back 137 years.

We hope you will continue to choose to be part of this relationship—we want to hear from you through our nrarepublications.org and americanrifleman.org websites. We'll use the most interesting communiques and those with the broadest reader interest in our "Readers Write" and "Favorite Firearms" columns. See them in this issue on pps. 24 and 36, respectively, for guidelines on how to contribute.

Finally, we encourage you to communicate your enthusiasm and support for firearms to your family, friends and coworkers and to the businesses and governmental entities that serve you. Together, we can preserve the great American tradition of choice—expressed most effectively through individual liberty, which is buttressed by firearm ownership.

—BRIAN C. SHEETZ, EDITOR IN CHIEF



Celebrating 20 years of maglula loaders in U.S.

US flag
UpLULA®
9mm - .45ACP universal
pistol magazine loader
& unloader - RWB



UP60US

Other available colors



- Fits single & double-stack mags
- Painless loading & unloading
- Highly reliable, lightweight
- Works like a champ, for years !

**World's best selling
magazine loaders !**

Over thirty professional pistol & rifle
mag loaders - Made in Israel

Ask your local dealer

maglula Ltd.
Since 2001

THE RIFLEMAN REPORT

“... the right of the people to keep and bear arms, shall not be infringed.”

As of this writing, the people of Ukraine are locked in a life-and-death struggle with the invading Russian military in the most significant warfare seen in Europe since World War II. Some of the many men and women, young and old, who have chosen to stay and fight for the future of their democracy could be seen on nightly newscasts prior to the invasion training with wooden dummy guns or actual firearms—outdoors, in homes and at ranges—in scenarios that recall scenes from the 2012 film remake of “Red Dawn.” But the fighting in Ukraine is real, with Russian troops, elite forces and even mercenaries striking in deliberate attacks on civilians.

Such carnage should evoke strong sentiments from any red-blooded American who believes that the defense of liberty from foreign or domestic tyrants is a fundamental human right. Still, many Americans can't imagine such a scenario occurring here. That is exactly the eventuality, however, that our Founding Fathers had in mind when they enshrined the Second Amendment in our treasured Constitution. In fact, it was considered important enough that it was placed immediately below the bedrock human functions of free exercise of religion, speech, the press and assembly. The Framers knew that, without the protection afforded by the people's possession of arms, the guarantees of the other rights were mere words on paper.

During the course of my private and professional life, I've had the privilege of traveling in at least 30 countries—some near the area now engulfed in war. In each case, the people's access to firearms was, by way of comparison to my own life experience, restricted significantly or prohibited outright. In time, I concluded that there simply is nowhere

else on Earth where the private ownership and use of firearms is exercised as it is here in America.

In this issue, we take a look at a wide variety of guns with ties to many parts of the world. In “High Power Redux: EAA's Girsan MCP35” on p. 52 Field Editor B. Gil Horman evaluates the latest clone of that classic American/Belgian design, which he found to be an affordable, well-made iteration that offers the late-model safety features. In “H&K's SL8: A G36 For American Sport Shooters” on p. 58, contributor Andy Massimilian finds the iconic German rifle to be a worthy entrant in the semi-automatic rifle marketplace. Also, on p. 64, take a look at our recap of coverage that garnered several manufacturers and one industry pioneer the coveted “2022 American Rifleman Golden Bullseye Awards.” On p. 68, Field Editor Rick Hacker takes us back to the beginning of a famous name in American gunmaking in “Striking Silver: Henry Repeating Arms Celebrates 25 Years.” Starting on p. 74, contributor Anthony Vanderlinden covers a little-known group of World War II combatants from the nation of Brazil in “Handguns Of A Forgotten Ally.” Then Field Editor Bruce Canfield examines a little-known aspect of U.S. martial arms intended for the Great War in Europe. Titled “America's Prototype ‘Trench Guns’ Of World War I,” it begins on p. 80.

Of course, there's much more coverage of guns in the Dope Bag and in our other departments throughout the magazine. As you enjoy it, I hope we will all keep in the front of our minds, and in our prayers, the people of Ukraine. As you continue to enjoy firearms for sport, hunting and competition, remember that we are among the few who can legally possess them to preserve our precious freedoms.

—BRIAN C. SHEETZ, EDITOR IN CHIEF

#1



UP60B

UpLULA®
9mm - .45ACP universal
pistol magazine loader
& unloader



**World's best selling
magazine loaders!**

Over thirty professional pistol & rifle
mag loaders - Made in Israel

Ask your local dealer

maglula Ltd.
Since 2001

THE RIFLEMAN REPORT



Our country's innovations in arms design and manufacturing have been key to individual liberty from the earliest days of the Republic. In the modern era, the informal title "America's rifle" has almost exclusively been applied to the AR-15—and for good reason. It is, after all, the semi-automatic iteration of our nation's frontline service arms. More than that, though, the AR is the platform on which several generations of American military personnel have been trained and have come to rely during and after their time in service. And, in the long-standing tradition of military arms being adopted by the civilian populace, it has become the darling of recreational and competitive shooters and hunters who by now are intimately familiar with, and comfortable using, such a light and compact rifle.

Despite the AR-15's inherent handling advantages and market ubiquity, however, its .223 Rem.-based frame has only infrequently been adapted—usually on a small scale and typically using modified or "borrowed" magazine designs—to the more capable .308 Win. cartridge family on which, ironically, Eugene Stoner's original AR-10 was based. It appears that times have changed.

In "Lightweight Heavy-Hitter: Ruger's SFAR" (p. 36), Executive Editor Evan Brune explains how the familiar industry giant has once again brought its considerable engineering and manufacturing muscle to bear in pressing the AR-15 further into the "general-purpose" category. The resulting Small-Frame Autoloading Rifle is an excellent example of arms innovation that has the potential to benefit even more American hunters, ranchers and self-defenders.

Contributor Matt Robertson, an inveterate practical rifleman, in "Getting Started In "Long-Range" Rimfire Competition" (p. 44), shares his experiences in learning about the somewhat-recent trend of .22 Long Rifle-based precision rifle shooting. It is an endeavor that not only helps longtime centerfire competitors stay

sharp and save a few dollars, but it also provides opportunities for new shooters to enjoy the camaraderie and thrill of competitive marksmanship.

And, remembering an obscure military rifle accessory that is more typically associated with the Great War, Field Editor Bruce Canfield uncovers "The V-B Rifle Grenade Launcher In World War II" (p. 50). Named after French developers Jean Viven and Gustave Bessiere, the so-called "tromblon" was a heavy metal cup that fit over the muzzle of a rifle. The U.S. military envisioned soldiers firing it at targets up to 200 yards away, and copies were adapted for the M1903 and M1917 rifles. But, as is sometimes the case with innovation, the V-B ultimately didn't make much of an impact.

In "Selby & The Superposed: A World-Class Shotgun Afire" (p. 56), contributor Joe Coogan recounts his time working for famed professional hunter Harry Selby in Africa and how a particular Browning Superposed over-under shotgun served to punctuate big-game pursuits by allowing safari clients, and Selby's young daughter, Gail, to bring birds to bag and provide an all-around delightful experience in camp. Of course, the Superposed is another excellent example of innovation for the masses by America's most accomplished arms designer.

And back to Ruger's SFAR on this month's cover—it might be best to think of it not as just another AR but as yet another example in a long line of American firearm innovations. Even more broadly, it is a symbol of how the free-market system, operating within the framework of a constitutional republic, creates an atmosphere for problem-solving and creativity that, in the world of firearms, leads to a more hopeful future for the citizenry and for freedom itself.

—BRIAN C. SHEETS, EDITOR IN CHIEF



Celebrating 20 years of maglula loaders in U.S.

US flag
UpLULA[®]
9mm - .45ACP universal
pistol magazine loader
& unloader - RWB



UP60US

Other available colors



- Fits single & double-stack mags
- Painless loading & unloading
- Highly reliable, lightweight
- Works like a champ, for years !

**World's best selling
magazine loaders !**

Over thirty professional pistol & rifle
mag loaders - Made in Israel

Ask your local dealer

maglula Ltd.
Since 2001

RIFLEMAN REPORT

These days, most Americans tend to think of technology in terms of electronic devices and the information they handle, and certainly, the strides in those areas during the past decade have been remarkable. But sometimes, the tasks of everyday life require different technologies—like those that have been the stock and trade of the firearm industry since its establishment. Whether in guns themselves or the cartridges they chamber or in optics or other firearm accessories, mechanical and material science innovations are key. This month's coverage explores several examples.

For instance, in the ever-evolving category of micro-compact-pistol designs that are the preference of the legions who have made personal defense a priority, Smith & Wesson has added a unique entrant: the CSX. In his cover story starting on p. 36, subtitled "A Hammer-Fired Micro In Metal," Field Editor Jeremiah Knupp takes a look at the gun's atypical features and construction, including an anodized-aluminum frame, and finds it to be an ultra-reliable choice for everyday carry.

And then there is the most recent development from a company that began as a result of a failed moose hunt more than 75 years ago. The incident that set John Nosler on a quest to build the definitive big-game-hunting bullet resulted in the Nosler Partition, which became the cornerstone of a firearm family dynasty. Today, Nosler is a major name not only in bullets and cartridges but also high-end bolt-action rifles and, now, sound suppressors as well. In "Nosler Enhances Its Legacy—Quietly," starting on p. 40, Senior Executive Editor Kelly Young evaluates two of the latest models—one all-titanium and one titanium/aluminum hybrid—available from the renowned Oregon firm and finds that, whether on an AR or a big-game bolt gun, the Nosler-branded "cans" are some of the most effective silencer options on the market.

Looking back a bit further to 80 years ago, Field Editor Martin K.A. Morgan examines "Guns Of Operation

Torch," starting on p. 48, which, while lesser-known than D-Day, was nonetheless a massive and important amphibious landing that occurred in French North Africa during World War II. The Allied invasion launched there was a hard-fought, six-month campaign, and it proved the soundness and durability of many of the U.S. military's small arms.

In one of the most significant examples of technical innovation in the modern shooting marketplace, Field Editor Aaron Carter explains in "True Velocity: Re-Defining The 'Metallic' Cartridge," starting on p. 54, how a Texas company has placed advanced polymers center-stage when it comes to the production of centerfire ammunition. Indeed, the cartridges produced by True Velocity Ammunition are not only somewhat unconventional in appearance, they presage a potentially industry-changing movement away from traditional brass-cased ammunition altogether.

In this issue's Opening Shot (p. 26), we also mark 20 years of "American Rifleman Television." Filming feature stories for the show, which airs on Outdoor Channel, has sent *Rifleman* staffers to myriad historic locales and facilities and showcases the expertise of longtime cameraman and editor Jake Stocke and BOSS Outdoor Productions owner Brian Godfrey. The show is hosted by NRA Publications Editorial Director Mark Keefe and staffed by the print magazine's editors who bring their vast collective knowledge to the evaluation of guns and optics in "Rifleman Review" segments and, with the help of a small cadre of expert colleagues, develop "I Have This Old Gun ..." segments. Since first airing in 2002, the show has won awards, gained a loyal following and, we believe, provided technical, educational, commercial and historical firearm content available nowhere else on the small screen.

Like the magazine you hold in your hands, "American Rifleman Television" is a project born of a passion for firearms. We sincerely hope you enjoy and benefit from both properties.

—BRIAN C. SHEETZ, EDITOR IN CHIEF



True Velocity .308 Win. cartridge



Celebrating 20 years of maglula loaders in U.S.

US flag UpLULA®

9mm - .45ACP universal
pistol magazine loader
& unloader - RWB



UP60US

Other available colors



- Fits single & double-stack mags
- Painless loading & unloading
- Highly reliable, lightweight
- Works like a champ, for years!

**World's best selling
magazine loaders!**

Over thirty professional pistol & rifle
mag loaders - Made in Israel

Ask your local dealer

maglula Ltd.
Since 2001

RIFLEMAN REPORT

The firearm industry has been a part of America since its founding, and while many companies have come and gone, a few have been on the scene for a century or longer. One that can be added to that list this year is Federal Ammunition, and in this issue we pay tribute to its owners, management and workers, past and present. Collectively, their hands have produced many billions of rounds of ammunition since the start of operations near today's Anoka, Minn., facility, and the company's cartridges have been fired by virtually every shooter in America.

The company originally called Federal Cartridge Corp. and now known simply as Federal, got off to a shaky start in 1922, but today it is the dominant force in the ammunition market. Its winding road to success and fame is captivatingly chronicled in "Shooting Straight For Ten Decades," starting on p. 40, written by Editor Emeritus John Zent. He traveled recently to the company's headquarters with NRA Publications Division Executive Director Doug Hamlin and Editorial Director Mark Keefe to meet with Federal CEO Jason Vanderbrink and scores of employees and other firearm industry members in celebration of the company's milestone.

We also have coverage of the respected Czech-based manufacturer CZ, itself now 103 years old, and an all-new line of long guns that it has just made available in a variety of configurations. *America's 1st Freedom* Editor In Chief Frank Minter explains in "CZ Re-Invents its Approach To The Bolt-Action Rifle" starting on p. 48. The European company, which also owns the Colt and Dan Wesson brands, operating through its CZ-USA subsidiary in Kansas City, Kan., has refreshed its commitment to American shooters with models that promise the same level of dependability and accuracy for which the CZ name has become highly regarded on both sides of the Atlantic. For me, the story served as a reminder of a visit more than 20 years ago to CZ's headquarters and manufacturing plant in the city of Uherský Brod. I came away from that multi-day tour of the country encouraged by examples of the Czech people's industrious, creative character that seemed to be re-emerging



at every turn after decades of suppression under communist rule.

In yet another new firearm development from a major American maker, Field Editor Aaron Carter's "Savage Takes A New Stance," beginning on p. 62, examines the first modern handgun to bear the name of company founder Arthur Savage, who got his start in 1894 with long guns and brought out his first handgun 115 years ago. In shaking out the new Savage pistol, Carter found it to be one of the most accurate he's ever tested—making it a fine match to the center-fire rifles for which the company has gained a well-deserved reputation.

Back to ammunition, we learned when putting this issue together that the Biden Administration had considered ordering Winchester Ammunition to halt the sales of excess 5.56 NATO cartridges produced at the Lake City, Mo., plant that it operates under contract for the U.S. military. Had that happened, ammunition supply on the civilian market, which by most accounts is still tight, would have become even more limited. It's another remarkable example of an administration seemingly intent on stifling the traditional American way of life and putting pressure on American shooters.

Despite that, our market currently offers more buying options when it comes to ammunition and firearms than any other in the world. And while we may value such choice as consumers, we must continue to actively cherish the freedom that results from the marketplace of ideas that is ensured only by our unique Second Amendment.

—BRIAN C. SHELZ, EDITOR IN CHIEF

Illustration courtesy of Federal



UP60B

UpLULA®
9mm - .45ACP universal
pistol magazine loader
& unloader



**World's best selling
magazine loaders!**

Over thirty professional pistol & rifle
mag loaders - Made in Israel

Available at your local dealer

maglula Ltd.
Since 2001

maglula.com

8

THE RIFLEMAN REPORT

In this issue, we report on two of the latest firearm designs—and highlight one now long forgotten—and we present a heartwarming story involving family-centric defensive firearm training. Altogether, they serve to illustrate that the American firearm industry and its consumers are a diverse community of responsible citizens who strive to serve one another's interests and, as a result, ensure a safer quality of life for the entire country.

In his story "The Ultimate Crossover: Beretta's A300 Ultima Patrol" (p. 36), Field Editor Aaron Carter tests one of the most advanced defensive shotguns on the market today—from one of the world's oldest companies. Having personally benefited from professional training with an earlier version of that platform, I can attest that the A300 Ultima's mechanical and ergonomic features, such as the wildly forgiving gas-operated action and expert-inspired ergonomics, are evidence that the modern scattergun continues to evolve and is more viable for self-defense than ever.

Field Editor B. Gil Horman, in "Trailblazer Pivot: A New Twist On The PCC" (p. 44), examines an interesting new take on the pistol-caliber carbine that is compatible with magazines from one of the most popular pistol brands on the market. Its unique design allows it to be quickly folded for handy transport and storage, and the story of its development is yet another reminder that innovation in firearms sometimes comes from "out of the blue." More broadly, though, it is a reminder that innovation from gifted minds, working alone or within established corporations, can only thrive within a free society that values and rewards the entrepreneurial spirit.

In "Arming My Daughter: A Defensive Handgun Trainer's Personal Tale" (p. 48), field editor and nationally known firearm trainer Justin Dyal relays how he addressed concerns for the safety of his daughter, Laney, by training her to shoot. One day of that experience was expertly captured by Senior Photographer Forrest



MacCormack, whose images have graced this magazine's covers and interior pages for 10 years. The story is a touching tribute to a father's love, and yet another powerful example of the positive, life-saving steps that responsible armed citizens can take toward a saner society.

Then, Executive Editor Evan Brune, in "The Dardick Handgun: A Famous Firearm Flop" (p. 56), re-visits the curious legacy of Ukrainian-born inventor David Dardick, whose open-chamber pistol and rifle concept and triangular-cross-section "tround" cartridges amounted to the proverbial "flash in the pan" of firearm history but little else in terms of sales.

And such is illustrative of how the firearm industry, or any other segment of the economy in America for that matter, ultimately rises and falls on the merits of its ideas. If they are sound and the products that result from them meet with demand in the marketplace, then they succeed. Of course, that formula is difficult enough even within the protections afforded by the broader freedoms unique to America. It's nigh impossible without them—especially the Second Amendment, which spurs creative minds to envision new and more efficient means by which law-abiding citizens can preserve their own lives and those of their loved ones.

So, while we thoroughly enjoy keeping NRA members abreast of the latest developments in firearms, optics, ammunition and other shooting-related gear, we are most motivated to remind our fellow citizens that the uniquely American right to keep and bear arms is one that our entire community of patriots must band together to preserve.

—BRIAN C. SHEETZ, EDITOR IN CHIEF

SEPTEMBER 2023  AMERICAN RIFLEMAN



Maglula Loaders Skip the Busted Thumbs

Dr. John Woods 02.19.15



BEHIND THE GUN
PODCAST

[LISTEN NOW](#)

BEST-IN-CLASS TRIGGER

If you want to subscribe to our monthly newsletter, please submit the form below.

Email* :

[SUBSCRIBE](#)



Life can dish out its share of annoying little injuries. I hate paper cuts, mashed fingers in doors, a slipped screwdriver into the hand, anything heavy dropped on my toes, and thumbs busted trying to push rounds into a pistol magazine. Well, those days are over, at least for the busted thumbs.

Loading brass cartridge ammo into single or double stack semi-auto pistol magazines can be a laborious, unpleasant chore. I don't know any shooter that gets his or her jollies out of jamming ammo down into a magazine. We all knew or hoped there had to be a better way. Well, there is.

Thanks to some brilliant engineering and product design work by Ran and Guy Tal of Maglula, Ltd., home based in Israel, magazine loading shooters now have a full line of Maglula loaders. Maglula is the acronym name that stands for "magazine loaders and unloaders accessories."

Their product line is extensive, so check out their [web site](#) to see everything they make in loaders for rifles and pistols. They established their company in 2001, marketing loader tools to military customers and now commercial-private use markets.

Here I am focusing on the [Maglula UpLULA loader](#) for pistols in 9mm, .357 SIG, 10mm, .40, and the .45ACP. UpLULA is the Maglula product family name for their pistol magazine loaders, a personal Universal Pistol (hence, the Up designation) magazine loader.

I first encountered the UpLULA at my own hunting club range when hunting friend and shooter Gary Starkey took one out of his range bag and demonstrated its use for me. He was using a .40 caliber Smith and Wesson at the time with a double stack magazine and was loading them up faster than I could thumb press 7 rounds into a Kimber 1911 mag.

Since I was using 10mm single stack magazines, he pulled out the alignment attachment accessory, snapping it on the bottom of the UpLULA loader to position the 1911 magazine perfectly for a quick charging of 7 rounds. It was so slick and easy, even I was impressed. I hardly wanted to give it back to him. As soon as I got back home to my computer, I ordered one for myself with the 1911 accessory piece.

The loader is just too simple to use. An empty magazine in any of the calibers listed above is inserted into the loader magazine channel box. The hand squeeze grip is pressed in, which engages an arm (they call it the "beak") that presses down on the magazine's follower.

When the follower is pressed down, a fresh loaded round is inserted into the magazine with the primer to the rear. Repeat the action until the magazine is loaded. It takes less time to fill a magazine than it does to describe it. I am certain, too, that there are YouTube videos online to guide you in the loading process as well if needed. One instructional video should do the trick. It really is that easy to do.

If you have straight body single stack magazines like the standard 1911s, then you snap on the accessory part on the bottom of the loader and proceed as above.

The Maglula UpLULA loader is made of a tough, heavy duty plastic product. The process of producing their loaders is highly detailed, including prototypes made by hand from metal, plastic, and wood, then precise 3D CAD models are created leading to injection molding processes to yield the final products. The loader is lightweight and easily fits into a range bag or even a shirt or coat pocket.

Quality control inspections are rigorous. This includes individually inspecting all products prior to packaging and shipment. Random samples are inspected and thoroughly tested as well. Just knowing their manufacturing processes can give the shooter a high level of confidence that they are buying a top notch product capable of complete reliability and long term functionality.

Maglula also makes a Baby UpLULA that is a smaller version of the one described here. The "baby" model functions in the same manner to reload pistol magazines for the .22LR through the .380 ACP. That includes the .32 ACP as well. Of course, they make an extended line of loaders for the .223 (5.56) and the .308 (7.62). Again, check out their web site for complete details and product descriptions.

So, there is no need to wear out your thumb and hand pressing down cartridges into a pistol mag one at a time. With the Maglula UpLULA, you can quickly reload empty magazines and get back to the fun part, shooting the pistol.

THE NEXT-LEVEL



FN
REFLEX™



SHOP NOW



DR. JOHN WOODS

Award winning outdoor writer/photographer since 1978. Over 3000 articles and columns published nationally. Field & Stream Hero of Conservation in 2007. Fields of writing includes hunting most game in American, Canada, and Europe, fishing fresh and saltwater, destination travel, product reviews, industry consulting, and conservation issues. Currently VP at largest community college in Mississippi in economic development and workforce training with 40 years of experience in Higher Education. BS-MS in wildlife sciences from MO. University, and then a PhD in Industrial Psychology. Married with two children and Molly the Schnoodle.



6 Comments

Login



Join the discussion...

LOG IN WITH

OR SIGN UP WITH DISQUS



Name

Share

Best Newest Oldest



JimS
9 years ago

I've got a few mag loaders of various types. The MAGLULA while being the most expensive is without a doubt the best made and is the best functioning. Wellworth the difference.

1 0 Reply Share



MrApple
9 years ago
Agreed.

0 0 Reply Share



Roger S
8 years ago edited

I'm not one to go out and buy every new gun gadget, But when a friend showed me this tool and I started using it I bought one right away and use it often. Well worth the money! Makes loading high cap pistol mags a breeze.

0 0 Reply Share



B. Young
8 years ago

Best mag loader on the market IMHO

0 0 Reply Share



1911doc
9 years ago

I'm not normally into gee wizzy, make your life e-z type stuff but the UpLULA is well worth it.

0 0 Reply Share



MrApple
9 years ago

Maglula makes an awesome product. I have several and have given even more of them away as Christmas presents.





Maglula Mag Loaders for Pistol & Rifle - LULA, UpLULA, BabyUp...

Share



0 0 Reply • Share

Subscribe Privacy Do Not Sell My Data

DISQUS



gher Capacity Magazines for M&P15-22

j Volk 02.19.15

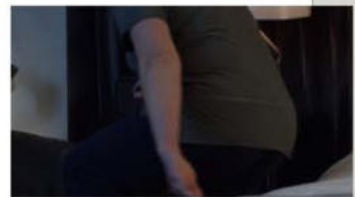

Preview: Maglula US-Flag Uplula Loader

by AMERICAN RIFLEMAN STAFF posted on April 20, 2022
NEWS, EXTRAS



Support NRA American Rifleman

DONATE



In a special-edition design celebrating Maglula's 20th year on the U.S. market, the popular Uplula pistol-magazine loader is now available in a red-white-and-blue color scheme. The pocket-size universal loader works with nearly every double-stack pistol magazine available, from 9 mm Luger to .45 ACP. Special inserts are available for single-stack M1911 magazines, and it will function with select .380 ACP magazines as well. Price: \$35. Contact: [Maglula; maglula.com](http://Maglula.com).

In this article

MAGLULA US-FLAG UPLULA LOADER, MAGLULA, UPLULA PISTOL-MAGAZINE LOADER, UPLULA, LOADING, AMMUNITION, HANDGUN, PISTOL, ACCESSORIES, TARGET SHOOTING, MAGAZINE

Related Stories

[Product Preview: Maglula Uplula](#)

[Preview: Holosun Enclosed Pistol Sight](#)

[Preview: Kestrel Ballistics KST1000 Shot Timer](#)

[The Keeffe Report: Maglula Takes On Amazon](#)

[NRA Gun of the Week: SIG Sauer M11-A1 Compact Pistol](#)

Most Popular

8 Tactical Lever-Action Rifles Available In 2023



8 Smallest Handguns You Can Own



Single-Stage vs. Two-Stage Triggers: What's The Difference?



Unofficial Enfields: The Gibbs Rifle Company Guns



New For 2023: Bersa BAR Series



3.0 Carbine Drill: Practical Exercise For The M1 Carbine

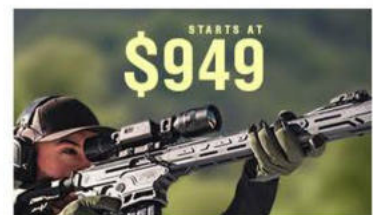

More like this from around the NRA



I Carry: Beretta 80X Cheetah .380 ACP Pistol in a PHLster Holster | An Official Journal Of The NRA



Handloads: A Just-Right .41 Mag. | An Official Journal Of The NRA



Exploded View: Luger P08 | An Official Journal Of The NRA



Summer '23 Firearm Sales Trend Decelerates | An Official Journal Of The NRA

Latest [MORE →](#)



Review: Taurus Raging Hunter 10" 460

In 2019, Taurus Intl. Mfg. Inc. introduced a successful series of big-bore double-action revolvers dubbed the Raging Hunters (RH).

[NEWS, REVOLVERS](#)



Editor's Choice: Savage Arms M1911

Savage is now in the M1911 pistol business with a range of .45 ACP and 9 mm Luger models that appear quite well-executed and display styling cues in concert with the company's cutting-edge image.

[NEWS, SEMI-AUTO HANDGUNS](#)



The Armed Citizen® Aug. 28, 2023

Read today's "The Armed Citizen" entry for real stories of law-abiding citizens, past and present, who used their firearms to save lives.

[ARMED CITIZEN, NEWS](#)



Unofficial Enfields: The Gibbs Rifle Company Guns

Alongside the many variations of official Lee-Enfield service rifles, in the United States, there exist a number of unique "unofficial Enfields" that have been created by stateside importers.

[NEWS, GUNS](#)



Preview: Big Sky Precision PinUltimate Titanium

Many folks who live in salt-laden environments know all too well the corrosive nature of sodium.

[NEWS, GEAR](#)



Single-Stage vs. Two-Stage Triggers:

THE YAMAHA LET'S RIDE SALES EVENT

WOLVERINE® RHAT™ 1000 SPORT
WOLVERINE® RHAT™ 1000 LE
WOLVERINE® RHAT™ 1000 SE

\$2500 CUSTOMER CASH*
AS LOW AS **5.99% APR** FOR 84 MONTHS*

YAMAHA Ride Your World™
[LEARN MORE](#)



What's The Difference?

A rifle's trigger is key to attaining the utmost accuracy. And, while crispness and pull weight are important traits, the manner in which it functions mustn't be overlooked, either. What is the difference between single- and two-stage triggers, and which is the best type for you?

NEWS, GUNS

[MORE LATEST STORIES →](#)

Interests [MORE →](#)

AMERICAN RIFLEMAN TELEVISION



Throwback Thursday: Battle for Belleau Wood | NRA Family
THROWBACK THURSDAY, #TBT, WORLD WAR 1

Shotshell Innovation At Winchester Ammunition | An Official Journal Of The NRA

I Have This Old Gun: Pattern 1851 Minié Rifle | An Official Journal Of The NRA

Rifleman Review: Smith & Wesson M&P Shield Plus OR In 30 Super Carry | An Official Journal Of The NRA

[ARTV →](#)

AMERICAN RIFLEMAN REVIEWS

I HAVE THIS OLD GUN



I Have This Old Gun: Pattern 1851 Minié Rifle | An Official Journal Of The NRA

PATTERN 1851 MINIE RIFLE, PATTERN 1851, I HAVE THIS OLD GUN

I Have This Old Gun: Pattern 1851 Minié Rifle | An Official Journal Of The NRA

I Have This Old Gun: Colt "American Railway Express" Police Positive | An Official Journal Of The NRA

I Have This Old Gun: Jacob's Double Rifle | An Official Journal Of The NRA

[I HAVE THIS OLD GUN →](#)

NRA GUN OF THE WEEK

ARMED CITIZEN PROTECTED BY SMITH & WESSON



The Armed Citizen® Aug. 25, 2023 | An Official Journal Of The NRA

ARMED CITIZEN, THE ARMED CITIZEN BLOG, THE ARMED CITIZEN ONLINE

NRA Women | The Armed Citizen® August 25, 2023

NRA Women | The Armed Citizen® August 18, 2023

NRA Women | The Armed Citizen® August 11, 2023

[ARMED CITIZEN →](#)

NEW FOR 2023

AMERICAN RIFLEMAN NEWS



Please Don't Put These Crime "Experts" in Charge | An Official Journal Of The NRA

CLAYTON CRAMER, CRIME, EXPERTS

NRA Hunters' Leadership Forum | Why We Hunt: Creating Lifelong Memories Near Reba's Place

CZ Recalls All-American Single Trap Shotguns | An Official Journal Of The NRA

Summer '23 Firearm Sales Trend Decelerates | An Official Journal Of The NRA

[NEWS →](#)

THE KEEFE REPORT



Review: Korth NXS 8-



Video Review:



Make Mine Metal: The



The Keeffe Report: True

[SHOW MORE INTERESTS](#) ▼

Get the best of American Rifleman delivered to your inbox.

[SUBSCRIBE \(IT'S FREE!\)](#)



GET IN TOUCH

- Advertising
- Contact Us
- FAQ
- Help
- Search

CONNECT WITH US



SECTIONS

- News
- Reviews
- Videos
- Armed Citizen
- NRA Gun of the Week

IN THE SPOTLIGHT

- American Rifleman Television
- NRA Institute For Legislative Action
- NRA Explore

NRA MEMBERSHIP

- NRA Membership
- Exclusive Member Benefits
- Membership FAQ
- Manage Your Membership



EXPLORE MORE NRA PUBLICATIONS



Find More Great NRA Publications Perfect For Every Interest



Join The NRA And Our Growing Community



Discover Everything That The NRA Has To Offer



Attend A Friends Of NRA Event Near You

Home » Gear

Magazine Loader – Video Demo & Review of Magloader, MAG Pump & Caldwell

Ammoland Inc. Posted on June 29, 2017 by Brian (Rev) Norris

Reverend Norris lays out his picks for the best gun magazine loader, with some curated video demonstration and review.



Gun Magazine Loader

USA – (Ammoland.com)- Let me confess that I've never thought much about ammunition magazine loaders or speed-loaders. Just like I put my pants on, one leg at a time, I load my cartridges like everyone else, one at a time.

ADVERTISEMENT

Advertisement

A PERFECT FIT FOR EVERY DAY









G43X MOS G48 MOS

[FIND A DEALER](#)

LOCK

★ EDITOR'S PICK

-  New Leak Shows ATF Will Pass Rule to Eliminate Private Sales
-  Best Red Dot for GLOCK 19 MOS Pistols & Installation Guides
-  Right to Arms in American Colonies Predated Bill of Rights
-  Best AR-15 Sling You Should Own ~ Video Review
-  Ammoland News Journalist Faces Gag Effort by US Attorney
-  Ruger Security-380 Handgun for EDC, Hands-On Review & Range Test

Advertisement

TARPEYO

IMMEDIATELY REDUCE URIC ACID



The first FDA-approved treatment proven to reduce protein levels in the urine of adults with IgA Nephropathy at high risk of disease progression

[LEARN MORE](#)

Before taking TARPEYO, tell your healthcare provider about all of your medical conditions, including if you:

- have liver problems
- plan to have surgery
- have chicken pox or measles or have recently been near anyone with chicken pox or measles
- have an infection
- have high blood sugar levels
- have stomach ulcers
- are pregnant or plan to become pregnant. TARPEYO may harm your unborn baby. Talk to your healthcare provider about the possible risk to your unborn baby if you take TARPEYO when you are pregnant.

SCROLL DOWN TO CONTINUE READING

Glock and some other manufactures include a mag loader with their handguns, but I never used them. I do own a **Maglula UpLULA**, but honestly, due to habit, it just lives in my range bag and gets rarely used.

However, recently during a Fighting Pistol class in Camden, TN, I found myself wanting more time for conversation and paying attention during the line changes devoted to reloading. Several of my fellow classmates were effectively using their mag loaders and completing their refills much more efficiently than me. So I fished around in my range bag and found my UpLULA. It's quite handy actually.

It is hard to break old habits, but this is clearly a more effective process.

So as a recent convert to the value of mag loaders, let me direct you to a few options worth your consideration. I have limited experience with a few of these, but I'm intrigued by them all. I plan to put them to use and take time to discover my preferences.

Here are my pick of the best ammunition magazine gun magazine loaders that deserve your attention:

- MagLULA UpLULA Magloader
- StriplULA Rifle Magazine Loader
- Mag Pump AR-15 Elite Magazine Loader
- Caldwell AR Mag Charger

MagLULA UpLULA Magloader , Fits 9mm to 45ACP Ammo



- (pre)diabetes or diabetes
- have glaucoma or cataracts
- have a family history of diabetes or glaucoma
- have or have had tuberculosis
- have high blood pressure (hypertension)
- have decreased bone mineral density (osteoporosis)
- are breastfeeding or plan to breastfeed. It is not known if TARPEYO passes into your breast milk or if it will affect your baby. Talk to your healthcare provider about the best way to feed your baby during treatment with TARPEYO

Tell your healthcare provider about all the medicines you take, including

PRESCRIBING INFORMATION

PATIENT PRESCRIBING INFORMATION

HOT DAILY DEALS

Wait What? Winchester 125Gr Open Tip 300 Blackout Ammo \$0.43 Each FREE Shipping

Eotech XPS3-0 Holographic Weapon Sight ... just \$499.00 FREE S&H USAVE \$250.00

Ammo Deals: CCI Blazer 9mm 115 Grain FMJ 1000 Rounds \$250.00 FREE S&H \$0.25ea

Bear Creek BC-15 Multi-Caliber Complete AR Lower \$119.99 40% OFF MSRP

Winchester 223 Rem 55 Grain Lake City FMJ 1000rds \$0.37 Each FREE S&H REBATE



The first FDA-approved treatment proven to reduce protein levels in the urine of adults with IgA Nephropathy at high risk of disease progression

LEARN MORE

medical conditions, including if you:

- have liver problems
- plan to have surgery
- have chicken pox or measles or have recently been near anyone with chicken pox or measles
- have an infection
- have high blood sugar levels (pre)diabetes or diabetes
- have glaucoma or cataracts
- have a family history of diabetes or glaucoma
- have or have had tuberculosis (hypertension)
- have decreased bone mineral density (osteoporosis)
- have stomach ulcers
- are pregnant or plan to become pregnant. TARPEYO may harm your unborn baby. Talk to your healthcare provider about the possible risk to your unborn baby if you take TARPEYO when you are pregnant
- are breastfeeding or plan to breastfeed. It is not known if TARPEYO passes into your breast milk or if it will affect your baby. Talk to your healthcare provider about the best way to feed your baby during treatment with TARPEYO

Tell your healthcare provider about all the medicines you take, including

PRESCRIBING INFORMATION

PATIENT PRESCRIBING INFORMATION

RECENT COMMENTS

Shotsmith: You've been trained to get the jab, wear a mask, shelter in, never question election results and worship the swamp...

Dr. Strangelove: Prickster is Jewish? No kidding.

hippybiker: And, the funny(sic)thing

UpLULA Magloader , Fits 9mm to 45ACP Ammo

The UpLULA features robust construction and efficient design. It's made to use with virtually all 9mm- .45ACP single *and* double-stack magazines. Most .380 and 1911 mags will work, too. I own the UpLULA in black, but if I had it to do over, I think I'd buy one of the fancy bright colors for the contrast in my range bag and for easy finding when dropped. You don't want to lose this handy little contraption.

StripLULA Rifle Magazine Loader



StripLULA Gun Magazine Speedloader

The StripLULA can't be found dancing at local clubs. She's a lady, thank you very much! The StripLULA is also made of military grade polymer and can be used to load stripper clips or (better yet) to load your AR mags ten rounds at a time. The StripLULA is also offered in a magazine loaders configuration made to use with Mini-14 mags.



Gun Magazine BenchLoaders?

*If ten rounds at a time magazine loaders aren't enough for your intended task, the BenchLoaders maybe the ticket for you. The Benchloaders are intended for ranges and other hard use applications. The end user is likely someone who will be **loading and Unloading** hundreds of magazines. With this loader, you can load thirty rounds of 5.56/ .223 at a time in one stroke. This product is offered in configurations designed for AR15, HKG36, IWI Galil, or Styer Aug & AR15, so be sure to get the appropriate model for your intended use.*

about is, that the Jewish mayor of SHITcago is pushing the travesty of justice!

Xaun Loc: I have a hard time believing that any "Pro-2A Organization" will need to contact Metcalf. From the description of his...

TGP389: They're BOTH to blame. There have been several times that the GOP held all the reins to government, and did...

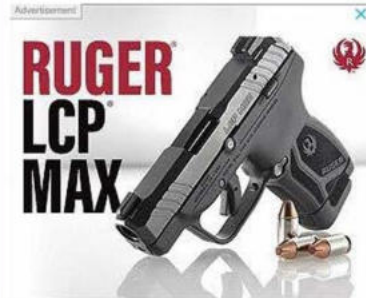

Mag Pump AR-15 Elite Magazine Loaders

The new-kid-on-the-block is the Mag Pump, the marketing looks promising and the word on the street is favorable.



Mag Pump AR-15 Elite Magazine Loader

Mag Pump offers the **MP-AR15 Elite**, the **MP-AR15**, and the **MAGDUMP**. The first two in that list are a bit pricey, but they appear to facilitate rapid loading with a robust mechanical advantage. Mag Pump claims 30 rounds in 30 seconds, and that appears quite feasible. Cutting your loading time in half means more range time, and that's a good thing.



You can dump the ammo into the top funnel, and the device orients each round correctly as it feeds into your magazine with each lever activation. The Elite model magazine loader is CNC machined out of aluminum billet, and all three models hold a lifetime transferable warranty.

Caldwell AR Mag Charger



Caldwell AR Mag Charger

Last on our list of magazine loaders is the Caldwell AR Mag Charger. It is one of the most cost-effective options listed, and it's the only option that's designed to work with fifty round boxes directly. Its plastic design isn't as robust as some of the other options, but it's likely sufficient for many range plinking sessions. This probably wouldn't be your go-to option if you are working at a range loading hundreds of mags a day, but it may be a great option for those of you looking to charge a handful of mags and plink away.



Ultimately, the whole mag loader conversation comes down to one simple question, how do you want to spend your time? Loading mags or shooting? That seems like a no-brainer. I will skip the loading grind and go with a magazine loaders. It's your time; enjoy it.



About Brian (Rev) Norris:

Brian (Rev) Norris, in addition to writing and talking guns and gear via video, is a pastor (hence the "Rev") who specializes in mentoring young men in the urban context. If he catches a moment of free time, you'll likely find him enjoying his family or heading to the range on his motorcycle. Brian has enjoyed the shooting sports since his father introduced them to him as a child. He's



an outdoorsman who enjoys life to the full.

Tags: [Best of the Best](#) [Gun Gear](#) [Product Reviews](#) [Top Five](#)



More Articles From Ammoland:

shareaholic



Primary Arms SLx 5X MicroPrism Scope Video Review & Range Test



IWI Uzi Pro 9mm Pistol Review - Bad-Ass or Pointless? ~ VIDEO



Top 5 Must-Have AK Magazines of 2022



EOTech VUDU 5-25x: The Smallest 25 Power Scope ~ VIDEO

Around The Web



Why Your Chainsaw Needs This Sharpener

Sherem



2 Insane Cards W/ 0% Interest Until Nearly 2025

CompareCredit.com



This Isn't Your Grandpa's Thc - It's Way Stronger!

HelloMood



Why Your Firewood Needs This Drill Bit?

Dotmails



Big Pharma Outraged! New Tinnitus Cure Discovered (Watch Shocking Video!)

Quit Tinnitus



If You Have Toenail Fungus Try This Tonight (It's Genius!)

Trendifyer

10 COMMENTS

⚡ 🔥 Most Voted ▾



Brian Norris

🕒 5 years ago

A couple of my bros are fire fighters I'll be sure to talk to them about it.

👍 0 🗨️



idadho

🕒 6 years ago

In the MagPump, it is not the bullet weight that causes proper orientation. It is the fact that the bullet is a smaller diameter and drops through a slot that the cartridge bases will not drop through. Not rocket science. You can load 30 rounds in 30 seconds after you spend a minute loading the hopper. These systems appear to just save the finger tips. I'll stick with my stripper clips and old school stripper clip loader. Preload the stripper clips at home, then quickly load a magazine at the range. 500 rounds in loaded stripper clips fit nicely in... [Read more »](#)

👍 0 🗨️



Isaac Miller

🕒 6 years ago

I'm still surprised that the MagPump hasn't been touted more! I know the developer of the device and it's quite awesome.

👍 0 🗨️



notalima

🕒 6 years ago

Plateloaders could have been added to this list. There are a handful of small operations that make them. I have a few from ACEM Plate Design and they are much liked at the range when I bring them out for our groups and events.

👍 0 🗨️



notalima

🗨️ Reply to [notalima](#) 🕒 6 years ago

Hah, looks like the editor added a link to my post. That product, while excellent, is about the most expensive plate loader you can get. Podavich runs about \$60-\$70, ACEM's run under \$50 for most, Magpacker just under \$40. I've used ACEM's and have the older AR-only model, newer AR multi-cal model, a smaller one for ARs to fit an ammo box, and a dedicated AK loader. They've all worked great. Looking forward to picking up their new pistol loader for 33rd Glk mags.

👍 0 🗨️



Bill N.

🕒 6 years ago

1 pistol loader and 3 AR types. Worthless article for hand gunners.

👍 0 🗨️



Gregory Romeu

🗨️ Reply to [Bill N.](#) 🕒 6 years ago

Yeah, must have something to do with the BASIS of the story as hidden by the title, that being a REVIEW of the particular loaders listed on said title?

👍 0 🗨️



Gregory Romeu

6 years ago

Great article, however, as usually brought up, WHY is there no PRICES mentioned?

0



M. Forsman

Reply to [Gregory Romeu](#) 6 years ago

In the time it took you to post your unedited comment, you could have Googled prices.

0



F Riehl, Editor in Chief Admin

Reply to [Gregory Romeu](#) 6 years ago

Greg, we get this question often enough. We don't include the prices as they change over time. Our article will be read for years and years online, so we have to make them timeless. Our articles look out of date when a year from now everyone is commenting that the prices quoted are wrong. We do provide links wherever we can so you do not have to search all over for the product our writer is talking about.

0

[Home Page](#) | [Recent Posts](#)

[Advertise](#)

[Contact](#)

[Drop a Tip](#)

[Disclaimer](#)

[Privacy Policy](#)

[Submit News](#)

[Subscribe](#)

[About Contributors](#)

[Back to Top](#)

Copyright 2023 AmmoLand.com Shooting Sports News | Sitemap | Μολών λαβέ



- Home
 - Shop
 - Read | Watch | Listen
 - Biz Directory
 - Insurance
 - Law
 - Permit Maps
 - Take a Class
 - Contact
- 0 items

Maglula Uplula – Coolest Product, Weirdest Name

By Matthew Maruster | October 18, 2021 | 1

- Facebook
- Twitter
- Pinterest
- LinkedIn
- Print

One of the weirdest product names I've come across is the UpLULA from Maglula Ltd. Of course, no one should criticize you for not knowing what the UpLULA actually is or does. But the product is so good it should probably be in every gun owner's range bag. I've used one for years and finally decided to write a post on the unknown gadget with the wacky name.



Background on Maglula Ltd.

The name UpLULA stands for – Universal Pistol Loader and Unloader Accessory. The company name Maglula stands for Magazine Loaders and Unloaders Accessories.

Besides having a unique name, the history of the UpLULA and its inventors is interesting and worth writing about.



Recent Articles – In Case You Missed It:

- NJ to Enact Gun Control Technology that Failed in Maryland
- 64-Year-Old Marine Corps Vet Sues Maryland Over Red Flag Law Allegation
- Man Fires 13 Rounds Through Door At Men Trying to Break into His Apartment-DGU Video
- S9E6: Updates in Tourmiquet Tech with Brian "Doc" McLaughlin
- Rugby Team Jumps into Action, Improvises to Help Save 2 People's Lives



Our Core Content

- Dry Fire Practice
- Gun Control



Birthplace of the UpLULA

The guys who engineered the UpLULA are father and son Ran and Guy Tal. The website explains a bit about Ran, who was born in Israel in 1936. Before engineering the magazine loading device, he lived an adventurous life. The site lists these events:

- 1952-1965: Agriculture, cotton & corn growing in a Kibutz Ramat-David, Israel.
- 1965-1967: In Africa, teaching modern agriculture to rural communities.
- 1969-1976: Inventing a method of pond fish reproduction in a Lab at Kibutz Ma'agan Michael, Israel.
- 1980: Establishing an (above) fish reproduction Lab. In Venezuela.
- 1976-1978 in Rockford, Illinois as a guest of the Jewish community.
- 1978: Developing a new technique of producing decorative rugs in the US.
- 1987-1990: Establishing a Custom-Made Rugs factory in Sydney, Australia.
- 1990-2001: Developing tools and accessories for the handicap.
- Since 2001 With son Guy, inventing Maglula's loaders.

Sadly, Ran died in 2019, but his son Guy continues with the company business.



What in The World is a UpLULA?

The UpLULA is a device that allows anyone to fill their pistol mags with ease. I've tested products from other companies designed to do the same thing. In the end, I've found the UpLULA to be the simplest to use out of all of them. That is why I always have one at the range and recommend it as an **essential range bag item**.

Maglula's standard UpLULA works on most 9mm, .357 SIG, .10MM, .40, .45 ACP and .22TCM single and double-stack pistol mags. It will also work on some .380 double stack magazines. For a complete compatibility chart, [click here](#).

The UpLULA comes in many different colors, and even an American Flag-themed version looks fantastic!

The UpLULA fits inside your palm. To use the device, you slip it over the magazine and press down. A tab on the UpLULA presses down the magazine follower, making room for the cartridge. You can easily drop a cartridge into the magazine, release the tension and retract the tab. Then, repeating the process, press the tab down on the inserted cartridge as you did on the follower.

It is much easier to show you how the device works, so check out the included video.



- Gun Safety
- Medical
- Shop Talk
- Statistics and Research
- The Laws
- Travel



Recent Videos



S9E8: Mythbusting Shooting Fundamentals – STANCE

6 views



Texas man describes firing at fake maintenance workers who tried to break through his apartment door

103 views

[Watch More Videos](#)



Often, people struggle to get the final couple rounds in their magazine because, at that point, the spring is very compressed. The UpLULA shines especially in these instances because the device provides much more leverage than your thumbs can.

The UpLULA is also helpful when you have many magazines to fill or shooting lots of rounds in a single-day range session. The less time you spend filling magazines, the more time you have for shooting. And your thumbs won't get tired out from filling magazines at the end of a 3-day course.



The device also works as an unloader. I don't often use this feature for my pistol magazines because it is pretty easy to unload them. But, as I will mention later, their products for loading and unloading rifles come in extremely handy, especially unloading 30 round AR-15 magazines.

More UpLULAs For Other Calibers:

Maglula makes UpLULAs for other calibers not covered by the standard UpLULA.

Maglula designed the 22UpLULA for loading .22LR wide-body pistol mags less than a 1/2", like .22LR converted 1911 mags and other .22LR converted mags. It has the body width of our UpLULA™ and has a narrower metal beak designed for .22LR rounds.

The Baby UpLULA works with calibers of .22LR through .380 ACP single-stack magazines.

Maglula makes some .22LR specific magazine loaders for folks looking for a particular application.

Other Maglula Products:

As I mentioned, Maglula didn't stop with just pistol mag loading devices. The company has products to work with 9mm, 5.56, 7.62, .308, and others. In addition, these products work with various size magazines for AR-15 and AK-47s, and bench loaders.

Counterfeit Warning:

Before I wrap this up, I will mention that Maglula has fought an intense battle against Chinese counterfeit products. But, unfortunately, these knock-offs were prevalent across Amazon and other of the fly-by-night online retailers.





Here is a photo of all the various products that appear to be Maglula products but aren't. We sell genuine Maglula UPLULAs in our online store. If you're a [Guardian Nation Member](#), you can apply your member discount to anything in our store.

Do you use a UPLULA? If not, why not? If you do, share your thoughts on its value.



About Matthew Maruster



I follow my Lord and Savior Jesus Christ who is the eternal co-equal Son of God. I currently live in Columbus, Ohio with my wife and daughter. I served in the Marine Corps Infantry. I was a Staff Sergeant and served as a Platoon Sergeant during combat in Iraq. After I was a police officer at a municipal agency in San Diego County. I have a Bachelors's Degree in Criminal Justice from National University. I produce the Concealed Carry Podcast and coordinate the Concealed Carry Instructor Network, and manage [MJ Maruster Defense](#).

[View all posts by Matthew Maruster](#)

Posted in [Gear](#) and tagged [magazine](#), [maglula](#), [range gear](#), [uplula](#)

1 Comment



Earl Hall on October 18, 2021 at 11:37 am

I have had an UPLULA Mag loader/unloader for quite some time and am totally pleased with it. Initially, friends of mine while at the range were amazed at how quickly I would load my magazines! It didn't take long before everyone bought and was using their own UPLULA! Great product!!

[Reply](#)

Leave a Comment

Comment

Name (required)

Email (will not be published) (required)

Website

Submit Comment

Follow Us:



Download Our App:



User Options

[User Dashboard](#)

[Login / Register](#)

[Order History](#)

[Affiliate Program](#)

[Join Our Newsletter](#)

Other Resources

[About ConcealedCarry.com](#)

[Become A Dealer](#)

[Advertise With Us](#)

[How We Work With Instructors](#)

[What Is Guardian Nation](#)

[Community Guidelines](#)

[Our Contributors](#)

[Dry Fire Gun Gear](#)

© 2023 Concealed Carry Inc. All Rights Reserved.

[Affiliate Disclosure](#) - [Terms of Use](#) - [Privacy Policy](#) - [Returns & Refunds](#) - [Shipping & Delivery](#) - [Affiliates](#)



1 (800) 409-9439 [Contact Us](#) [Track Your Order](#)

Search for products, categories, ...

[My Account](#) [Wishlist](#) [My Cart](#)

ALL MAGAZINES ▾ AMMUNITION ACCESSORIES GUN PARTS RANGE GEAR BRANDS GUNMAG EXCLUSIVES SALE THE MAG LIFE BLOG



Search the MagLife blog ...

[Podcast](#) [Reviews ▾](#) [News ▾](#) [Insights ▾](#) [Skill Building ▾](#)

Maglula UpLULA Mag Loader: Save Your Thumbs

Reviews

Posted on February 15, 2023 • by [William Lawson](#)

3 Minute Read 0 Comments

If you shoot semi-automatic firearms, you likely know that loading magazines isn't all that fun. After two or three mags, those freedom seeds start wearing on your thumbs. And if you're preloading mags for a big range day or training course, your hitchhiker implements will be sore indeed. Well, Maglula UpLula Universal Pistol Mag Loader saves your thumbs and, once you get the hang of it (not long), loads your mags even faster.



The Maglula UpLula loads your mags faster and saves your thumbs. (maglula.com)

A Versatile Product

Magazine loaders have been around for a while, but many are caliber, and even magazine, specific. For instance, my Walther PPQ

came with a Walther mag loader, which is great. It's a nice accessory. But it only works with 9mm rounds and with Walther mags. It will probably work with some other brands, but not all, as I have learned.

But once I picked up the [Maglula UpLula Universal Pistol Mag Loader](#), my Walther and Beretta mag loaders stay in my "miscellaneous gun stuff" drawer. Why carry two or three mag loaders when one suffices for almost every magazine-fed pistol you might own? The UpLula mag loader is compatible with the following calibers:

- 9mm
- .357
- 10mm
- .40 S&W
- .45 ACP

Its wide body accommodates single and double-stack mags. Mag length is a non-factor, as the UpLula just slides over the top. It also eliminates loading wear on your magazines' feed lips, since it completely bypasses them, increasing your magazines' service life. It is fully ambidextrous. The UpLula also unloads your mags quickly and efficiently, saving wear on your thumbs.



The UpLULA is very handy on the range. (Author's Photo)

The UpLula is made of tough reinforced polymer, though the loading beak is steel, ensuring maximum durability and consistency. It's also light and compact, coming in at only 2.6 ounces. It's an easy addition to your range bag or even your pocket. The package contains easy-to-follow instructions, though the UpLula functions like other pistol mag loaders.

Maglula offers the UpLula in many colors, including black, dark green, brown-orange, lemon, purple, and pink. There's also a red and blue US Flag model.

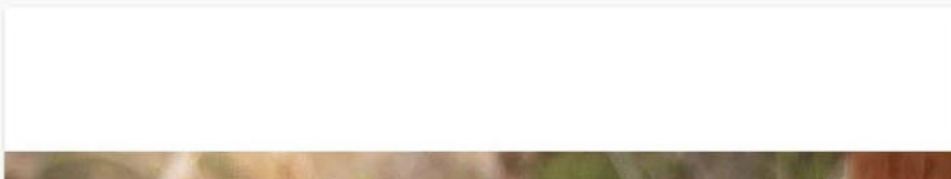



The UpLula is available in lots of colors. (maglula.com)

A Few Limitations

Maglula's instruction card does note some things regarding the UpLula of which buyers should be aware:

- The UpLula will not load magnum magazines.
- May not be compatible with some mags. The company provides a complete list at maglula.com.
- May not load the last round in some mags.
- The company advises loading the first round in each magazine by hand to prevent the steel beak from scratching the follower.
- A separately sold 1911A1 Aligner helps load single-stack mags by eliminating any instability but is not necessary.





The Maglula 1911 A1 Aligner inserts into the UpLula to stabilize single-stack mags. It's sold separately but is not necessary. (maglula.com)

Beware of Counterfeits

Maglula notes that dozens of Chinese imitations infringed on their patents, flooding the market with cheap products. The company spent millions of dollars in a five-year lawsuit against Amazon and has had most of those removed. But make sure you know what you're buying. The real thing is worth a few extra bucks.

Conclusion

The UpLula is a great product. I now own several. One for the range bag, one that lives with my magazines, and one that seems to float around wherever I need it. I've never had a minute's trouble with any of them, assuming I use them correctly and don't get distracted. I may or may not have tried to go too fast while talking to a friend and flipped the rounds in the magazine. But that was totally me, not the UpLula





The UpLULA retired my Walther and Beretta mag loaders. (Author's Photo)

As noted, I like having a mag loader that handles all my pistol mags. It saves space and I don't have to keep up with multiple items. The UpLula has proven to be durable and reliable, and I expect to get years of service from them. If that sounds good to you, give the UpLula, or other Maglula mag loaders, a shot. You can get them right here at GunMag Warehouse. Your thumbs will thank you.

0 Shares

Facebook

Twitter

Email



William Lawson

William "Bucky" Lawson is a self-described "typical Appalachian-American gun enthusiast". He is a military historian specializing in World War II and has written a few things, as he says, "here and there". A featured contributor for Strategy & Tactics, he likes dogs, range time, and a good cigar - preferably with an Old Fashioned that has an extra orange slice.

Sign Up for Newsletter

Let us know what topics you would be interested:

- News
- DIY
- Reviews
- Podcast
- Training
- New Products

Sign Up

Related Articles





A Holster For The AK: Blue Force Gear's Standard AK Sling

Reviews

August 25, 2023



Let There Be Light: The Family of ProTac Weapon Lights

Insights

Reviews

August 25, 2023



Vaultek LifePod Portable Safe: Safe, Effective Storage?

Reviews

August 24, 2023



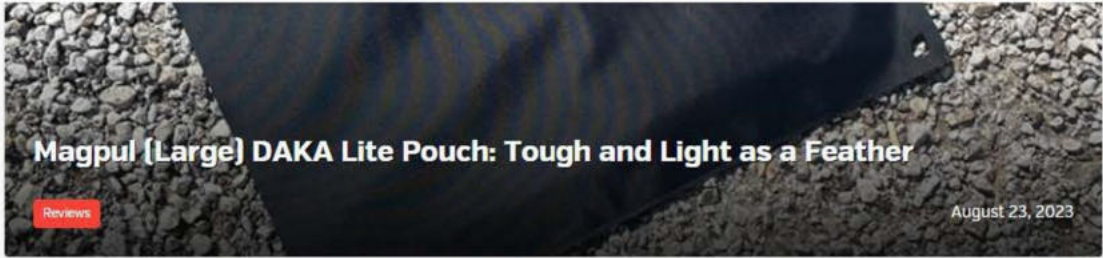

0 Comments

 Login ▾



Start the discussion...

LOG IN WITH

OR SIGN UP WITH DISQUS 





Name

 • Share

Best Newest Oldest

Be the first to comment.

 Subscribe  Privacy  Do Not Sell My Data

DISQUS

Customer Service

[My Account](#)
[Wishlist](#)
[Order Status](#)

Information

[About GunMag Warehouse](#)
[Affiliate Program](#)
[Jobs & Careers](#)

Contact

Email an expert at
support@gunmagwarehouse.com
or call us at **1 (800) 409-9439**



Subscribe Now
Log In
Give a Gift | Subscriber Services

SHOT SHOW 2023 GUNS AMMO GEAR GUN ROOM LEARN NEWS WATCH THE MAGAZINE

All What are you looking for?

Advertisement



It's our duty to build the best performing firearm..

Gear / Accessories

Maglula To The Rescue - Loading Your Magazine Quickly

Advertisement



August 24, 2017
By Patrick Sweeney



The Baby UpLula will load single-stack magazines without a projecting side pin for cartridges between .22 and .380. The 22UpLula is a new .22LR double-stack loader for wide-body pistol mags. \$39

It's an adage so old that I'm sure even Socrates thought it was a groaner: "When I was a kid, I had to walk to school barefoot in the snow, uphill both ways."

It brings to mind the good old days of competitive shooting when we loaded magazines by hand. We had to scoop loose rounds out of a box and thumb each one into the magazines. The saving grace was that we were usually doing it with 1911 magazines in .45. I still

remember one day of practice when I realized I had gotten so grooved into the routine that I had spent the entire day loading eight-round magazines and had not once scooped seven or nine rounds out of the box. Only eight rounds, each and every time. That was an indicator that I needed a life outside of guns.

Today, large-capacity magazines are as common as dirt, and thumbing 15 rounds or more can be work. What to do?

Advertisement

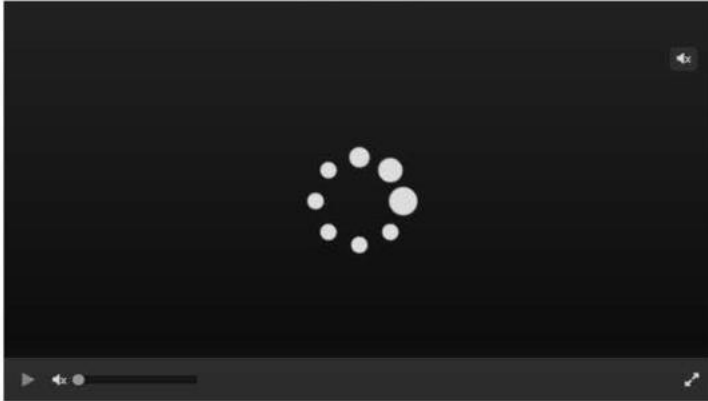

Maglula to the rescue.

Maglula was founded in 2001 in Israel by Ran Tal and his son, Guy Tal. Magazine loaders are not new; the first was most likely invented during World War I. However, most of the designs prior to Maglula could be charitably described as useless — worse than not having a mag loader.

Photo Gallery

[> See all Photos](#)



Maglula's solutions differ in that they are molded from high-strength polymer. They are not simply bent metal strips that are supposed to help you (and always slip out of alignment). The Maglula designs are sturdy housings that either slip over or clamp on to the magazine.



Get The Magazine

Subscribe & Save.

Digital Now Included!

[Subscribe Now](#)

Advertisement

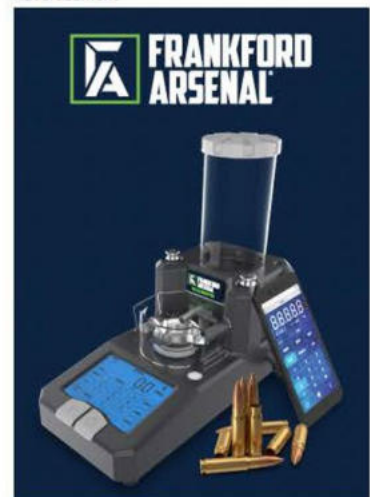



The UpLula is Maglula's best seller, and for good cause. It works for most single- and double-stack mags from .380 to .45 ACP. \$39

Someone out there is thinking, *Loading magazines is a hassle? How can that be?* A box of 50 is no big deal, but load up 200 to 300 rounds in a day's practice, and it gets to be work. Do it several times a week, and you begin to wonder why you are practicing. Your fingers get sore, your thumb gets chewed by the feed lips, and if you get in a hurry or are tired and clumsy, by the end of a practice session, you can damage the feed lips by forcing a round in that wasn't quite lined up.

Video That May Interest You

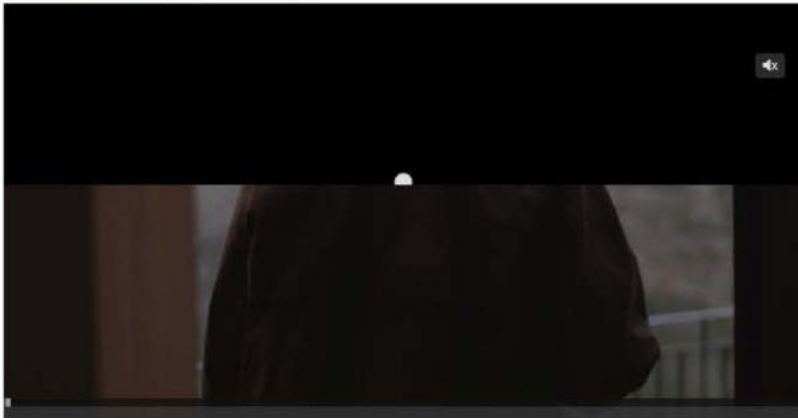

 Bluetooth
INTELLIDROPPER
ELECTRONIC POWDER MEASURE
[SHOP NOW](#)



Some years ago, I had to torture test a Browning Hi Power by myself. I had enough magazines on hand to load 200 rounds at once. Each range session would start with the magazines already loaded. I'd shoot them empty, load them up and shoot again. Four hundred rounds in a range trip (in addition to all the other work). By the time I finished the 23,000 rounds of the test, I was so sick of loading those magazines that I stuck with revolvers for a while. Had I not found a Maglula to use partway through the test, I might have never finished. The Maglula was a lifesaver, making the on-range reload of the magazines less of a burden and almost fun. (Emphasis on *almost*. In all honesty, I cannot describe loading any magazine as "fun.")

I can't claim any records here, however. Maglula has had high-volume units sent back for study, like the UpLula SCCY returned after they loaded more than a million rounds with it.

The process of using a Maglula takes longer to describe than learn, and once learned, you can load a magazine quickly. Maglula lists the loading time of a magazine as something like 30 seconds, which may seem long. It might not seem as though you're saving much time. But you should not compare the time it takes to load the first magazine of the day against your first attempts with the Maglula. Instead, compare the time (and effort) it takes at the end of a practice session against practiced loading *with* the Maglula. It is when your hands are sore and tired that the difference really manifests itself.

Recommended



Trijicon RMR HD & RCR Red-Dot Sights: First Look

[Read Article](#)



The Big Picture: Bushnell RXM-300 Reflex Sight

[Read Article](#)



Top 7 Tools For Working On Guns

[Read Article](#)



The Successful 5.11 Brand and its Devoted Evolution

[Read Article](#)

Advertisement

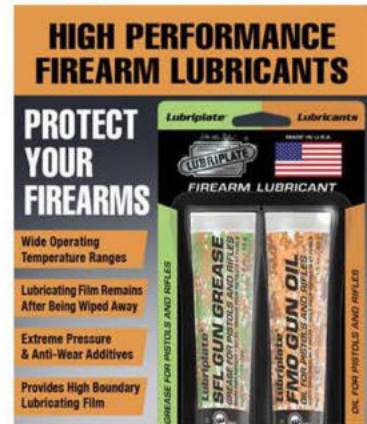

Advertisement



Just to verify, I grabbed the same Hi Power mags I loaded back in that test and checked my efforts against the clock. Twenty rounds took 37 seconds with my hands and 22 seconds with the UpLula. And no feed-lip-gouged thumbs with the UpLula, either.



With a single stroke, the new Range BenchLoader will shove 30 rounds of 5.56 NATO or .223 Rem. cartridges into any STANAG 4179 (AR-type) magazine without inserts or adjustments. \$133

The proliferation of AR-based pistols has made the Maglula even more of an asset. If you are using a 9mm pistol-caliber carbine or an AR pistol as an everyday carry trunk gun or for competition, you likely aren't loading 15-round magazines. You are stuffing 20, 30, even 40 rounds or more into a magazine.

While there are good magazines (the SIG Sauer 9mm mag design ranks as one of the best), the most common is perhaps the worst ever made: the Colt 9mm. Not only do the old Colt mags occasionally spew rounds at random, but once you've gotten 18 to 20 rounds into a 32-rounder, you practically need a mallet to stuff any more. I have literally poured ammo onto a table and, holding the magazine upside down, loaded the magazine by pushing the magazine lips down over the ammo. Ugly? Yes. Potentially damaging to the feed lips? You betcha. But the alternative of scouring my thumbs before I'm halfway done with practice is not in the cards.

The Maglula for the infamous Colt 9mm magazine makes it possible to fully load one without a mallet.

The standard handgun model, the UpLula, loads 9mm through .45 and works on a host of handgun magazines. The webpage lists the few magazines or types that it can't load. But if you have one UpLula, you have a loader for almost all your magazines. As if that wasn't enough, you can have it in one of six different colors. Having learned to shoot at a time when the choices were blued steel, stainless steel and shades of walnut, the idea of a pink or purple loading accessory is one I'll have to get used to. At least in the four colors that aren't subdued (pink, purple, lemon and orange-brown), you are much less likely to lose your UpLula or have it "mistakenly" wander off at the local range.

The carbine loaders are listed as SMG loaders, which is fair. There, you have to be model specific, as the magazines differ so much that they don't work well across brands. That isn't a problem, as few of us have more than one brand to load for.

How popular are they? Maglula sells their loaders worldwide. When the Swiss Army adopted Glocks, they also ordered 12,000 UpLulas to go with them. Maglula has nine U.S. patents, and they do everything in-house.

Advertisement

& Anti-Wear Additives
Provides High Boundary Lubricating Film
Oxidation Inhibitors Prevent Gunning
Protects Against Rust and Corrosion

LEARN MORE

Lubriplate
FIREARM LUBRICANTS

Newark, NJ 07105 / Toledo, OH 43605 / 800-733-4755
 Buy Online At: www.lubriplate.com/falubes

Advertisement

RENEGADE BOTTOMLAND

TAKE ON ANYTHING

SAVAGE

LEARN MORE



The modern measure of success is how many people want to steal your design. Maglula reports that there are a whole lot of fakes out there being sold online. If you want to be sure you get the real-deal item, don't go to China. Go to a reputable dealer like Brownells, or go down to the local gun shop and pick up one (or more).

The universal UpLula has a retail price less than most boxes of ammo. Why don't you have one already?

For more information, visit www.maglula.com.

Read The Next Article: [Trijicon RMR HD & RCR Red-Dot Sights: First Look](#)



Enjoy articles like this?
Subscribe to the magazine.
Get access to everything Guns & Ammo has to offer.

Subscribe to the Magazine

GET THE NEWSLETTER
Join the List and Never Miss a Thing.

Advertisement

An advertisement for Frankford Arsenal's Intellidropper. On the left is the Frankford Arsenal logo, which consists of a stylized 'A' inside a square. To the right of the logo is the text 'FRANKFORD ARSENAL'. In the center is a photograph of the Intellidropper device, which is a small, blue and black electronic scale. To the right of the device is the text 'INTELLIDROPPER' in large, bold, white letters, with 'ELECTRONIC POWDER MEASURE' in smaller white letters below it. On the far right is a white button with the text 'SHOP NOW' in black.

Recommended Articles

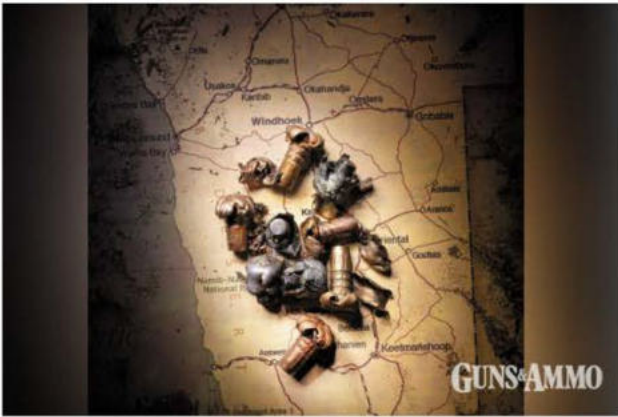

7mm Remington Magnum vs. .270 Winchester: Tested and Compared
Eric R. Poole



Camp Guns: Sometimes Perfect, Other Times Not — But Often Essential!
Craig Boddington



Buyer Beware: Buying 'Bargain' Guns Can Be Risky
Keith Wood



Ruger Reintroducing the Marlin Model 1895 Trapper Lever-Action Rifle
Guns & Ammo Staff



How to Choose the Best Scope Reticle for Your Application



Self-Defense Handgun and Ammo Options for People With

Tom Beckstrand



Wilson Combat 6mm ARC Rifles: First Look

Guns & Ammo Staff

Dexterity and Strength Issues

Jeremy Stafford



5 Best Red-Dot Optics for SIG Sauer P365X & XL Pistols

Richard Nance



Wilson Combat SFX9 5-Inch Solid Frame 9mm Pistol: First Look

Guns & Ammo Staff



Colt King Cobra Target 22LR Rimfire Revolver: New for 2022

Guns & Ammo Staff





Mossberg 940 Pro Tactical Optic-Ready Autoloading Shotgun: First Look

Guns & Ammo Staff

Recent Videos



Optics

First Look: Trijicon RMR HD & RCR



Handguns

Guns & Ammo Magazine: September 2023 Issue



Handguns

Springfield Armory Echelon: First Look



Handgun

Guns & Ammo Magazine: August 2023 Issue



Handgun

Guns & Ammo Magazine: July 2023 Issue



Handguns

Wilson Combat SFX9 5" Full Review



Learn

Guns & Ammo Magazine: May 2023 Issue



Industry

Guns & Ammo Magazine: March 2023 Issue



Rifles

New Stocky's Rifle Stocks for 2023





Rifles

New for 2023: Christensen Arms Modern Hunting Rifle (MHR)

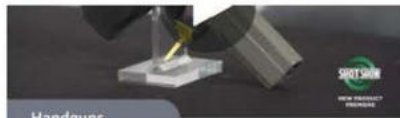

Handguns

New for 2023: All-American RIA 5.0 Sporting Pistol



Suppressors

New for 2023: FN Rush 9Ti Pistol Suppressor

[See All Videos](#)



GET THE MAGAZINE
Subscribe & Save
 Digital Now Included!

[SUBSCRIBE NOW](#)

[Give a Gift](#) | [Subscriber Services](#)

[PREVIEW THIS MONTH'S ISSUE](#)

Buy Digital Single Issues



Don't miss an issue.
 Buy single digital issue for your phone or tablet.

[Buy Single Digital Issue](#) on the Guns & Ammo App

Other Magazines

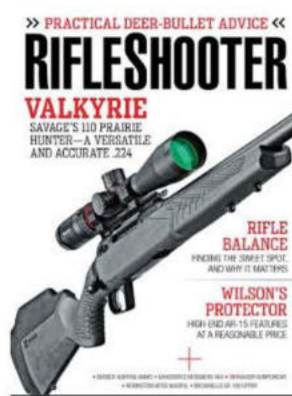

See All Other Magazines

Special Interest Magazines

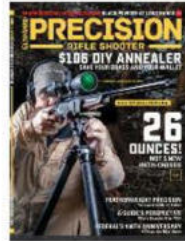
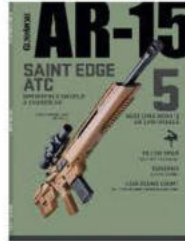

See All Special Interest Magazines

Advertisement

More You May Be Interested In



HANDGUNS

RIFLESHOOTER

SHOOTING



GET THE NEWSLETTER

Join the List and Never Miss a Thing.

Get the top Guns & Ammo stories delivered right to your inbox every week.

Add an email address

Sign Me Up

GUNS&AMMO



GUNS AND AMMO

- Guns
- Ammo
- Gear

- Watch
- News
- Gun Room

Which gun do you want to read about?

SEARCH

EXCLUSIVES: IN SELF-DEFENSE



GUNS AMMO GEAR DISCOVER EXPERTS VIDEOS SHOP SUBSCRIBE (🎧) PODCAST



ACCESSORIES

CLEANING

HOLSTERS

KNIVES

LIGHTS & LASERS

SIGHTS & OPTICS

UPLULA MAGAZINE LOADER

EASE THE PAIN AND SHOOT MORE!

WRITTEN BY DAVID FREEMAN

GEAR | ACCESSORIES
2019

1



Uplula

The UplULA loader comes in six colors. David's choice was hi-vis yellow, with his

name applied in marker, to prevent “walk off” at the range.



Uplula

The compact UpLULA Magazine Loader by Maglula.

Loading magazines is one of the challenges new shooters always encounter — especially people with hand-strength or pain issues. For years I taught people how to load magazines, stressing the importance of a good handhold and steady pressure in the right direction when inserting cartridges. Then came a day I could no longer do it without the aid of a magazine loader.

I've tried several magazine loaders with varying degrees of success but the one that works the best for me is the UpLULA by MagLula. This handy little loader fills pistol magazines quickly and easily meaning you'll spend less time at the range loading magazines and more time shooting. Moreover, it doesn't hurt because your fingers and thumbs aren't pushing against a strong spring and they aren't getting pinched by parts of the magazine. With practice, you can load as fast as one round per second.



Uplula

Even the pro baseball player who came into David's shop tried one and bought it immediately!



Uplula

The UplULA loader is simple to use: Press down, squeeze the lever, drop the round and go shooting!

Press, Squeeze, Drop, Load

Hold the magazine upright with the bottom resting on a solid surface. Place the loader over the top of the mag, press down lightly while squeezing the lever to depress the follower, drop in a round, and push the lever quickly to push it into the mag. Repeat the process until the magazine is full. Everyone who has tried it found the loader simple and easy to operate. We even had a professional baseball player in our store one day and handed him one to try. Not only did he buy the UpLULA, he told all his shooting friends about it. In fact, I can't remember ever offering it to someone who didn't buy one.

The UpLULA is made of a tough military-grade polymer and it's available in six colors. I got one in high-visibility yellow and put my initials on it with marker so it wouldn't walk off. The pink ones go off the shelf quickly while many guys want macho colors like hunter green, dark orange or black.

The loader locks in the closed position when not in use so it takes up minimal space in pocket or range bag. You can use it with single- and double-stack 9mm, .357 SIG, .40 S&W, 10mm, .45 ACP magazines, and some .380 mags. Cost is around \$35 wherever shooting accessories are sold.

<https://www.maglula.com>

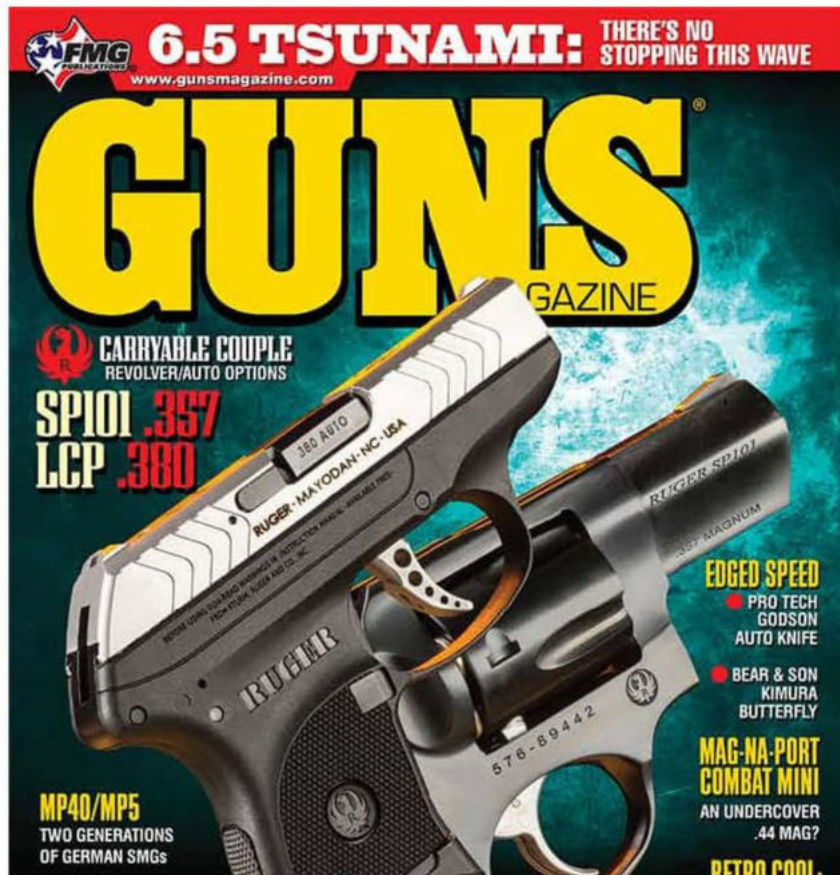



Purchase A PDF Download Of The GUNS Magazine May 2019 Issue Now!

GEAR | ACCESSORIES

2019



WE THINK YOU'D BE INTERESTED IN THIS, TOO



DOUBLE VISION



Every upland bird hunter, whether his game is pheasants, grouse, quail, chukars or even wild turkey, ought to have at least one double-barrel shotgun. In my...

[READ FULL ARTICLE](#)

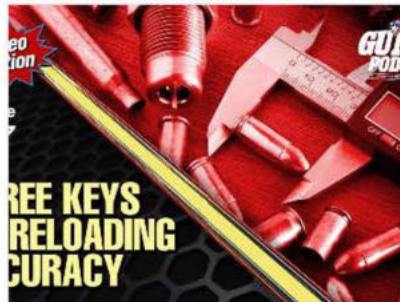

3 KEYS TO...



Reloaders are always chasing smaller groups, and in this episode, expert reloader and editor of *American Handgunner* Tom McHale shares his top three tips for...

[READ FULL ARTICLE](#)



LION TAMERS



As this was being written, authorities in Jefferson County, Washington, on the north side of the Olympics National Park, were looking for a mountain lion...

[READ FULL ARTICLE](#)

BECOME A GUNS MAGAZINE INSIDER

SIGN-UP TO RECEIVE FREE DOWNLOADS, NEWS, OFFERS, AND MORE!

ENTER YOUR EMAIL ADDRESS

SUBMIT



SHOP
ABOUT
CONTACT

GIVEAWAYS
VIDEOS
ADDRESS CHANGE

SUBSCRIBE
ADVERTISING
MISSING ISSUE



AMERICAN
HANDGUNNER

AN FMG PUBLICATIONS PRODUCTION | 225 W VALLEY PARKWAY, SUITE 100 | ESCONDIDO, CA 92025 | (866) 820-4045

MADE BY **SIDEKICK**

Home / Best Of / 5 Best 9mm Magazine Speed Loaders [2023]

5 BEST 9MM MAGAZINE SPEED LOADERS [2023]

By Dave Chesson May 29, 2023 0 comments  4.7 (36)

One of my least favorite things to do at the range, is loading my magazines. Granted, I've gotten better and faster over time, however, it's still pretty tedious and a bit of a pain.

However, one day a range buddy of mine broke out a speed loader, and he was firing down range faster and more often than myself. He specifically started using them because of his arthritis in his hands, and needed the a good speed loader.

But, as you can imagine, not all speed loaders are the same. Since that day, I've purchased a bunch of speed loaders for different calibers. Some of them were junk, while others were not. Some, while they worked, were over priced.

Because of my use of these (and subsequent collection), I'm constantly asked what is the best 9mm speed loader. With **the 9mm pistols** being one of the most widely used, its no wonder this is commonly asked.

So, to help with this, I'm going to be listing some of my favorite speed loaders on the market for the 9mm – and also a couple of duds that you should avoid.

5 BEST 9MM SPEED LOADERS FROM BEST TO WORST

1. **Caldwell Universal Pistol Loader** (Editor's Choice)
2. **Maglula 9mm UpLULA Universal Pistol Magazine Loader** (Best Premium)
3. **MakerShot Custom Magazine Speedloader** (It's 3rd)
4. **ETS Elite Tactical Systems CAM Universal Speed Loader** (Fastest Option)
5. **Glock Magazine Speed Loader** (Best for Glock)

Best 9mm Speed Loaders

EDITORS CHOICE CALDWELL UNIVERSAL PISTOL LOADER



- Versatile with many different calibers
- Adjustable Side Shims
- No Movement Tightening Knob
- Stable with no flexing

[BUY ON AMAZON](#)

BEST PREMIUM MAGLULA UPLULA UNIVERSAL LOADER



- Positive operation protects fingers
- Lengthens magazine life
- Locks closed & minimal design

[CHECK PRICE](#)

3RD MAKERSHOT MAGAZINE SPEEDLOADER



- NOT a universal loader
- Perfect fit on selected magazine
- Great speed, ergonomics and durability.

[BUY ON AMAZON](#)

FASTEST OPTION ETS CAM UNIVERSAL SPEED LOADER



- Loads pistol mags in seconds.
- Works with 9mm, .40 caliber, double or single stack mags.
- Picks rounds up from ammo tray.

[BUY ON AMAZON](#)

BEST FOR GLOCK GLOCK MAGAZINE SPEED LOADER



- Loads all calibers
- single and double stack magazines
- No inserts, spacers or adjustments

[BUY ON AMAZON](#)

REVIEWS OF THE BEST 9MM MAGAZINE SPEED LOADERS

Okay, so now that you can see my list, let me explain a bit more on why each one is where it is at, and how they compare. This section is really for those of you who need more detail. Otherwise, you can save yourself some time and just choose #1 above.

1. EDITOR'S CHOICE CALDWELL UNIVERSAL

LOADER



CALDWELL UNIVERSAL LOADER

[CHECK LATEST PRICE](#)

Best for Compatibility

- Versatile with many different calibers
- Adjustable Side Shims
- No Movement Tightening Knob
- Stable with no flexing

Design	A
Durability	A+
Reliability	B+
Value	A+

OUR GRADE

A

Reviewed by
Dave Chesson

READER'S GRADE

A-

Based on
9 Reviews

YOUR GRADE



Do You Own This Accessory?
Leave A Review

Caldwell Universal Loader Review

While it looks like a weapon out of the movie Terminator, I find the Caldwell Universal Loader is very easy to use and is very compatible with most 9mm magazines while taking no strength to operate.

The Caldwell speed loader works with both single stack and double stack magazines – which usually isn't the case. It can load multiple caliber sizes which include 9mm, 10mm, .357, .40cal and .45 cal ammunition. You don't need a lot of strength with this baby, you can lock it in with the provided Lock Knob, throw in a round, and pull the lever. I think its the easiest on the hands.

This loader can easily adjust to different widths of magazines with supporting adjustable side shims . On top of all of this, it is made from polycarbonate which makes it practically indestructible. Overall, a fantastic option for any serious shooter.

My only issue is that this one takes a bit to get used to. It can feel a bit clunky at first, but once you get the hang of it, it's pretty simple. Also, this isn't the fastest of them but it will definitely increase your speed. I listed this as my favorite though because of its price and that it covers other calibers and hasn't failed me yet.

CALDWELL LOADER SPECS

Operating Function	Squeeze Lever
Magazine Types	Single Stack, Double Stack
Weight	8 ounces
Overall Size	9.3 x 6.7 x 2 inches

Caldwell Universal Pros And Cons

✓ Universal for caliber types

! Takes some getting used to

[CHECK LATEST PRICE](#)

2. BEST PREMIUM MAGLULA UPLULA UNIVERSAL LOADER





MAGLULA UPLULA UNIVERSAL LOADER

[CHECK LATEST PRICE](#)

Best for Durability

- Positive operation protects fingers
- Lengthens magazine life
- Locks closed & minimal design

Design	A
Functionality	A
Durability	A
Value	B+

OUR GRADE

A

Reviewed by
Dave Chesson

READER'S GRADE

A

Based on
21 Reviews

YOUR GRADE



Do You Own This Accessory?
Leave A Review

Maglula Uplula 9mm Loader Review

Coming in a little more expensive than the Caldwell, the number 2 on my list is the Uplula Universal Magazine Loader. It is made with military grade material – which that statement always makes me chuckle and vets know why.

It also carries the ability to self-adjust to any size magazine because of its shims and loads with ease. I've used it to load 9mm, .45, and .380 without any problems. So, it too is very versatile as is the Caldwell. The key to this magazine speed loader is reliability, without any pain!

Made to load both single and double stacks, this piece of equipment is also made with indestructible polycarbonate, so it's strong.

I also think this is one of the easiest on the hands. My kids have been able to use it without any extra help (can't say the same for the ETS – discussed below).

MAGLULA LOADER SPECS

Operating Function	Squeeze Lever
Magazine Types	Single Stack, Double Stack
Weight	0.8 ounces

Truth be told, this UpLula Loader is a favorite and you'll find it in the range bag of a few of us here. It just didn't make my #1 spot because of the price. Plus, I've had some issues with it not sitting as flush with the 9mm magazines (but maybe that's just mine?)

But, if that doesn't matter, then this is the one for you. Call it the 'premium' option.

Maglula Loader Pros And Cons

✓ Highly durable and light

! Higher Cost

[CHECK LATEST PRICE](#)

3. MAKERSHOT MAGAZINE SPEEDLOADER



MAKERSHOT MAGAZINE SPEEDLOADER

Best for Simplicity

- NOT a universal loader
- Perfect fit on selected magazine

[CHECK LATEST PRICE](#)

Design	B+
Durability	A
Functionality	A

- Great speed, ergonomics and durability.

Value

B

OUR GRADE

A-

Reviewed by
Dave Chesson

READER'S GRADE

C

Based on
4 Reviews

YOUR GRADE



Do You Own This Accessory?
Leave A Review

Makershot Magazine Speed Loader Background

This magazine loader is simple! There is no moving parts and it easily slides onto any single or double stack magazine.

Made of excellent polymer material, this magazine speed loader is small enough to carry in your pants pocket and it won't break.

What is not so great about this speed loader is that it is NOT universal. It is limited to 9mm, .40, and .380 caliber magazines.

So if you like basic and you don't mind using some thumb strength, then you will love the Makershot Custom Speed Loader. I personally don't think it is better than the Uplula or the Caldwell, but I have a crazy Uncle who won't shut up about it.

MAKERSHOT LOADER SPECS

Operating Function	Push Slider
Magazine Types	Single Stack, Double Stack
Weight	3.04 ounces
Overall Size	1 x 1 x 2 in

Makershot Loader Pros And Cons

✓ No moving parts; slides easily

! NOT universal

[CHECK LATEST PRICE](#)

4. FASTEST OPTION ETS CAM UNIVERSAL SPEED LOADER





ETS CAM UNIVERSAL SPEED LOADER

[CHECK LATEST PRICE](#)

Best for Speed

- Loads pistol mags in seconds.
- Works with 9mm, .40 caliber, double or single stack mags.
- Picks rounds up from ammo tray.

Design	B+
Durability	A-
Functionality	B-
Value	B+

OUR GRADE

B+

Reviewed by
Dave Chesson

READER'S GRADE

D+

Based on
19 Reviews

YOUR GRADE



Do You Own This Accessory?
[Leave A Review](#)

ETS Tactical Speed Loader Review

I personally like the ETS Tactical Speed loader. It is definitely one of the fastest of the speed loaders and I've never had ANY problems with mine.

With the way it is designed, you never even have to touch the pistol ammunition itself. It will easily grab the bullets for you by sliding it along a tray of 9mm rounds in the provided grooves. All you do is load it up from the ammo box, insert the magazine loader in the bottom until it locks, and then push down the bullets into

ETS ELITE LOADER SPECS

Operating Function	Push Slider
Magazine Types	Single Stack, Double Stack
Weight	3.04 ounces

the magazine with a provided plunger. It's incredibly easy.

Overall Size	13.5 x 1.5 x 6.2 inches
--------------	-------------------------

It does take a little bit of strength to operate, but overall very simple. Again, this works with both a single stack magazine and a double stack magazines. Because you never have to force the bullets through the feed lips, it doesn't have any danger of getting damaged. It is made of sturdy polymer here in the USA.

However, one of the best things about Gun University is that any of the products we list, we give our Critics Score, and we allow readers to leave their scores. As you can see, there are many who have had problems and because of this, I have updated this article to lower it on the rankings.

Many have complained that it didn't work for them or that, like I mentioned, it does take a bit of strength to operate. My kids can't use it – I have to operate it for them. But that being said, I haven't run into any malfunctions or issues with mine, or any of the others I have used from other people. So, I'm not really sure about that.

ETS Elite Loader Pros And Cons

✓ Speed and quickness

! Other readers report issues with it

! Need strength to operate

[CHECK LATEST PRICE](#)

5. GLOCK MAGAZINE SPEED LOADER





GLOCK MAGAZINE SPEED LOADER

[CHECK LATEST PRICE](#)

Best for Cost Efficiency

- Loads all calibers
- single and double stack magazines
- No inserts, spacers or adjustments

Design	B
Durability	B+
Functionality	B+
Value	A

OUR GRADE

B+

Reviewed by
Dave Chesson

READER'S GRADE

B-

Based on
7 Reviews

YOUR GRADE



Do You Own This Accessory?
Leave A Review

Glock Magazine Loader Review

The Glock Magazine Speed Loader is the most cost efficient one out today. Glock prides itself on ease of use and strength, and their speed loader delivers on that promise.

While it's not the fanciest, it is made with very durable polymer and is the most cost effective.

No mechanics or parts to have to deal with, the Glock makes good on being easier on the hands and fingers. To use this product all you do is place it over the magazine, slide the ammo in, and push down the handle.

The Glock magazine speed loader is compatible with the Glock 9mm, .40, .357, .380, and the .45 calibers. Just be aware that there are a few Glock products it is NOT compatible with such as, the Glock G42 single stack and the 10mm magazines.

So, this is great if you have a Glock and you're only going to use it on Glocks. If you have other types of 9mm pistols, then move off this one and choose one of the ones I discussed above.

GLOCK LOADER SPECS

Operating Function	Push Slider
Magazine Types	Single Stack, Double Stack
Weight	0.8 ounces
Overall Size	1 x 1 x 2 in

Glock Loader Pros And Cons

✓ Cost Effective

! Not compatible with ALL Glock Mags

CHECK LATEST PRICE

BEST 9MM SPEED LOADER – BUYER’S GUIDE

There are many things to think about when looking at a 9mm speed loader for your gun. Luckily, in case you need more information before purchasing one, we've got the below guide to get you up to speed.

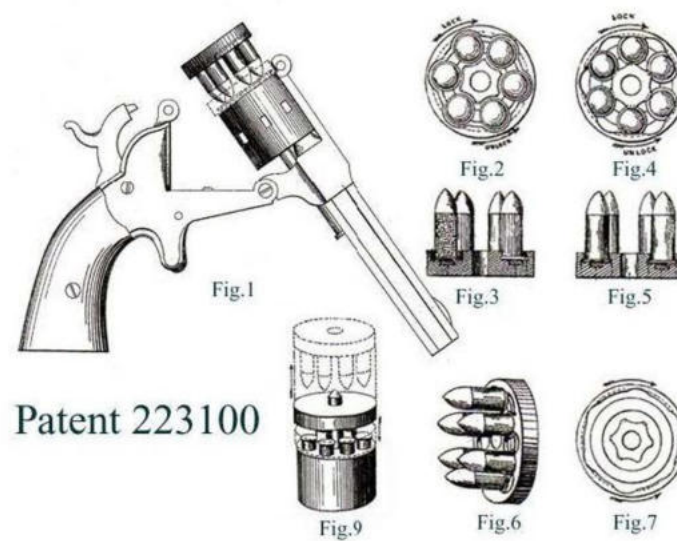

HOW DOES A 9MM SPEED LOADER WORK?

With so many speed loader options today to tell you HOW each one works would be a very big undertaking. So to keep it brief and to the point here is a high level view of how a speed loader works.

1. Start with an empty gun magazine.
2. Place the magazine into the "slot" provided.
3. Insert a round of ammo into the space or gap designed for placement.
4. Push or squeeze so the ammo gets loaded into the magazine chamber.
5. Repeat until magazine is fully loaded.





Considerations When Purchasing

When deciding to buy a 9mm speed loader, there are 3 things you're going to want to consider.

The first is making sure you have the correct speed loader for the correct magazine and caliber. You don't want to have something that's too big or small, this may cause problems during operation and loading rounds causing all sorts of problems. You don't want to be that person that thinks that a speed loader is universal just because it is called a speed loader.

Second, is durability. You really do tend to get what you pay for. So when deciding on a magazine loader you might as well get something that's reliable and is built to last.

Finally, choose something that suits you. Meaning if you are not very strong or you struggle with arthritis in your hands, get something that you can squeeze rather than push down. Vice versa, if you are strong and have no issues with your hands you can be more flexible to get something that works well for you.

Overall, the important idea to remember is to just get something, you're going to need it and your hands will thank you!

FAQS

Do speed loaders damage magazines?

Interestingly, loading and reloading by hand can likely do more damage than using a magazine loader. As long as you are using the mag loader correctly, you shouldn't have any issues.

Is a magazine speed loader worth buying?

If you're looking to save on time and also save your thumbs from ache and even potential injury, then absolutely – a magazine speed loader is worth every cent.

Are mag loaders universal?

No. A lot of magazine speed loaders are not universal. This article is a great resource for understanding which mag loader is best for you and I highly suggest reading through.

ACCESSORIES

Now you should be on your way to getting a speed loader as a must have accessory. We can't forget some of the other accessories that everyone should also consider. Here are a few options that you might need to replenish or buy for the first time.

1. HOPPE'S LUBRICATING GUN OIL



- High-viscosity oil refined to perfection
- Ideal for firearms, fishing reels and other precision mechanisms
- Extra-long lasting; Does not harden, gum or expire

[CHECK PRICE](#)

2. SHOOTER CHOICE GUN GREASE



- Odorless
- Clings to metal surfaces
- Quick and Easy to Apply

[CHECK PRICE](#)

3. SHOOTER'S CHOICE 9MM CLEANING KIT



- Cleans .38cal/9mm pistols
- Solid brass rod section with female 8/32 threaded end
- 2" 9mm cotton bore mop

[CHECK PRICE](#)

Rate

Click on a star to rate it!



Average rating 4.7 / 5. Vote count: 36

Subscribe To Our Newsletter

Join our mailing list to receive the latest news and updates from our team

PREVIOUS

[Best AR-15 Optics : Which Optic is Right for you?](#)

NEXT

[Best Bullet Pullers On The Market: Do You Even Need One?](#)

ABOUT DAVE CHESSON



Dave Chesson is prior Navy with a specialty in international arms dealing for the US government across multiple countries. Having traveled the world and abided by ATF and ITAR, Roy has a unique background in legal as well as practical capabilities of weapons deployment and use.

Recent Posts



BINOCULAR VS MONOCULAR: WHICH IS THE RIGHT TOOL FOR THE JOB?

July 12, 2023



GLOCK 43 VS GLOCK 26: MINI GLOCK 9MM COMPARISON

July 12, 2023



SPRINGFIELD ECHELON REVIEW – HANDS-ON WITH THE NEW PISTOL

July 12, 2023









GLOCK 21 VS GLOCK 19 COMPARISON

July 11, 2023



GUN UNIVERSITY

The best place on the internet to learn about guns. Need help choosing the best weapon? Click on a gun to read one of our unbiased gun reviews below!

<p>Bergara Wilderness Terrain</p> 	<p>Our Grade A</p> <p>Fan Grade: A+</p>
<p>CZ P-09</p> 	<p>Our Grade B+</p> <p>Fan Grade: B</p>
<p>Diamondback Sidekick</p> 	<p>Our Grade A-</p> <p>Fan Grade: TBD</p>
<p>S&W Equalizer</p> 	<p>Our Grade B+</p> <p>Fan Grade: A+</p>
<p>Beretta 1301</p> 	<p>Our Grade A</p> <p>Fan Grade: B-</p>
<p>Sig P320 Compact</p> 	<p>Our Grade A-</p> <p>Fan Grade: A-</p>
<p>Ruger LCR 22LR</p> 	<p>Our Grade A-</p> <p>Fan Grade: C-</p>
<p style="text-align: center;"> SEE WORST GUNS SEE BEST GUNS </p>	

Search..



Finding Scope Rings Has Never Been Easier

Free online tool

1. Select your rifle and scope
2. Shows you the rings &



bases that work

3. Finds the cheapest price



JOIN OUR NEWSLETTER

Get gun deals, educational content and updates on law changes daily!

Email Address

SUBSCRIBE >



[ABOUT US](#)
[CONTACT US](#)
[PRIVACY POLICY](#)

AMAZON AFFILIATE DISCLAIMER

We are a participant in the Amazon Services LLC Associates Program, an affiliate advertising program designed to provide a means for us to earn fees by linking to amazon.com and affiliated sites.

© 2023 – Gun University, All Rights Reserved



MagLula Uplula Mini Review





Before I picked up my S&W M&P9, I snagged a 10 round magazine locally and had a few days to play around with it. One of the things I quickly figured out is that it was pretty hard on the fingers to reload. The first round was a bit hard to start, the tenth very hard, and everything in between just wore on my fingers very quickly. When I picked up my M&P, I was happy to see that it came with the range kit and a Maglula UpLULA for loading magazines. I thought it was special enough to do a quick mini review on.

Operating the Maglula UpLULA

Operation of the UpLULA is simple once you've used it once. The little nub on the side needs to be pulled up to release the mechanism but beyond that, all anyone needs to know to use it is that the metal tongue depresses the follower or rounds down to make room for the next one. I've got the operation in images at the bottom of this post, and in video just below.

Video Review of the Maglula UpLULA loading S&W M&P9 Magazines



PS to Smith & Wesson: the S&W M&P is about the hardest product name in the world to search for parts for. Practically none of the forums or stores I searched would support searching for the M&P because the product name was so short and because it included an ampersand (&).



Maglula Uplula



Uplula side



uplula side opened



uplula compressing follower

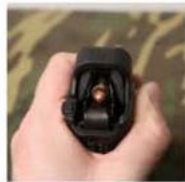

uplula with bullet in



uplula releasing



next round

Posted April 10, 2014 in [Equipment Reviews](#)
by Adriel

Tags:

The Hunting Gear Guy

We Love It: Maglula UpLULA

by NRA WOMEN STAFF posted on April 28, 2020
NEWS, HOW-TO, TIPS & TACTICS, FIREARMS, GEAR



Support NRA Women

DONATE

The Maglula UpLULA may be one of the most useful little gadgets the firearm industry makes, and it's certainly one of the easiest and safest ways to load and unload your gun. We don't want to sound like we get upset when loading magazines wrecks our manicure—really we don't—but the fact of the matter is that the process of getting ammunition into a given gun's magazine and then back out again can be a real pain. (Ask anyone who's ever caught a nail under the lip of the magazine and left half of it in there ... ouch!) The UpLULA is your one-way ticket out of Ouchtown. Here's what we mean.

The UpLULA is a universal pistol magazine loader and unloader, and it essentially does all of the work for you. When we say "universal," we



mean it; the UpLULA self-adjusts to your magazine, encompassing calibers from 9 mm Luger to .45 ACP (and even some .380 ACP too). It works with just about every kind of major magazine manufacturer out there, as well, including (but not limited to): Astra, Auto Ordnance, Barak, Beretta, Browning, Bul, Colt, CZ, EAA, FN, Glock, HK, Hi-Point, High Standard, Jericho, Kahr, Kel-Tec, Kimber, Les Baer, Llama, Luger, Magnum Research, Para Ordnance, Phoenix Arms, Ruger, Sigma, Sig/Sauer, S&W, Springfield Armory, Star, Steyr, Taurus, Vector, Walther, and more.

To load the UpLULA, you just drop the rounds in without pushing or pressing with your thumb. Your fingers and your magazines will enjoy the extra protection the UpLULA offers, even as you load hundreds of rounds at the rate of about one per second—about a third of the time it takes to do it manually.

Watch [this video](#) to see how easy the UpLULA is to use.

Most Popular

6 Great Shotguns for Women



The Dos and Don'ts of Gun Range Attire



Understanding Hammer-Fired vs. Striker-Fired Pistols



Do .22 LR Pistols Make Sense for Self-Defense?



What Shot Size Should You Use?



Do .410 Bore Shotguns Make Sense for Home Defense?



This highly durable, military-grade universal loader can go with you just about anywhere, since it's about the size of a standard pocket



STARTING AT \$499 [LEARN MORE](#)

and weighs just over 2 ozs. The one place it won't go, however, is on a website that isn't one of Maglula's trusted retailers. The company has alerted us that there are a number of inexpensive (and inadequate) "knock-offs" making the rounds, and would like you to know that they only sell through trusted brick-and-mortar stores and the following websites: Academy, Brownells, MidwayUSA, Cabela's, BassPro, Gander Outdoors, Turner's, CheaperThanDirt and ShopRuger. Although prices may vary a bit from retailer to retailer, you can expect to pay approximately \$30. For more information about the UpLULA, [click here!](#)

In this article [GUN GEAR, TIPS & TACTICS, RANGE GEAR, UPLULA, MAGLULA](#)

Related Stories

[6 Pieces of Gear You Need for Long-Range Shooting](#)

[5 Ways Shooting Sports Enthusiasts Are Already Prepared for an Emergency](#)

[Tips & Tactics | Tatiana Whitlock: Transition With a Handheld Light](#)

[Tips & Tactics | Kristy Titus: Preparing For a Hunt](#)

[Tips & Tactics | Gabby Franco: Think Effectively](#)

More like this from around the NRA

presented by **NRAEXPLORE**



First Look: Lockedin Grip Liquid Shooting Sports Chalk | An Official Journal Of The NRA



Why Shooters Should ALWAYS Wear Eye & Ear Protection | NRA Family



Safe Range Wear: A Cautionary Tale | NRA Family



NRA Women | 6 Tips to Get More Comfortable With Carrying Concealed

Latest [MORE →](#)



Sharing Laughs with Gun Haters

The magic of conversations loaded with nuance and enthusiasm is that they're fun to have with other people—sometimes the very people we'd assume we'd come to blows with, but end up laughing with.

[NEWS, LIFESTYLE, FIREARMS](#)



3 Ways to Be a Team Player at the Range

Most shooters want to help each other and welcome new shooters to the range, continuing our shooting traditions and keeping the Second Amendment strong.

[NEWS, HOW-TO, LIFESTYLE](#)



SIG Sauer to Host October ROSE Retreat with Lena Miculek

The ROSE Retreat is an industry-first, luxury, all-inclusive event bringing women together for a shared experience through a guided journey of personal safety.

[NEWS, LIFESTYLE, EVENTS](#)



Bullet Twist Rates Made Simple

Twist rates get complicated quickly. But what's the bottom line you need to know?

[NEWS, HOW-TO, TERMINOLOGY](#)



The Armed Citizen® August 25, 2023

A woman who feared for her life when a man attempted to pry open her car—while she was in it—used her firearm to defend herself.

[NEWS, ARMED CITIZEN](#)



4 Tips for Instructing Students Who Lack Confidence

The challenge of instructing an individual who lacks confidence can be difficult, but can be overcome by incorporating different teaching methods and learning tools.

[NEWS, HOW-TO, LIFESTYLE](#)

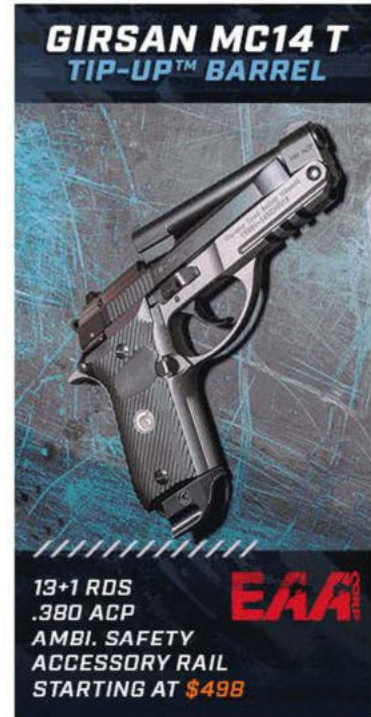

[MORE LATEST STORIES →](#)

Women's Interests [MORE →](#)



REFUSE TO BE A VICTIM®



EDDIE EAGLE GUNSAFE® PROGRAM



NRA FAMILY



NRA SCHOOL SHIELD





NRA Hunters' Leadership Forum | Hunters and Beyond: NRA Women Are All Under One Roof

NEWS, NRA WOMEN, WOMEN OF THE NRA

4 Fascinating Firearms Seminars at 2022 NRA Annual Meetings & Exhibits | NRA Family

High School, College Students Benefit by NRA's Refuse To Be A Victim Program | An Official Journal Of The NRA

NRA Personal Protection Expo Coming to Texas | An Official Journal Of The NRA

[MORE REFUSE TO BE A VICTIM® →](#)



Did the Mainstream Media Just Endorse an NRA Program? | An Official Journal Of The NRA

MARK CHESNUT, EDDIE EAGLE, EDDIE EAGLE GUNSAFE PROGRAM

NRA Hunters' Leadership Forum | Media Champions Eddie Eagle-Like Gun Safety Message, Ignores NRA's 35-Year Child Safety Program

NRA-ILA | Media, Academics Tout Eddie Eagle-Like Safety Program

NRA-ILA | Kansas Legislature Adjourned Sine Die From the 2023 Session

[MORE EDDIE EAGLE GUNSAFE® PROGRAM →](#)



New NRA Family Member? Win the Baby Shower With TacticalBabyGear.com | NRA Family

BARBARA MELLONI, TACTICAL BABY GEAR, NRA FAMILY

NRA Publications Names Mark Keefe Editorial Director | An Official Journal Of The NRA

NRA Publications Editorial Director John Zent Retires | An Official Journal Of The NRA

NRA Women | Points of Impact: November 14, 2020

[NRA FAMILY →](#)



NRA Women | NRA School Shield Grant Program Now Accepting Applications for School Security Projects

NRA, NRA SCHOOL SHIELD, NRA FOUNDATION

30 Years Of Giving Back | An Official Journal Of The NRA

Standing Guard | Your NRA Does A Lot More Than It Gets Credit For | An Official Journal Of The NRA

Firearm Training Preps Utah Teachers | An Official Journal Of The NRA

[NRA SCHOOL SHIELD →](#)



NRA WOMEN



NRA WOMEN ON TARGET®



NRA WOMEN'S WILDERNESS ESCAPE



NRA YOUTH EDUCATION SUMMIT

[SHOW MORE WOMEN'S INTERESTS ▾](#)



GIRSAN MC14 T TIP-UP™ BARREL



13+1 RDS
.380 ACP
AMBI. SAFETY
ACCESSORY RAIL
STARTING AT \$498

Get the best of NRA Women delivered to your inbox.

[SUBSCRIBE \(IT'S FREE!\)](#)



GET IN TOUCH

- Contact Us
- Advertising
- Writers' Guidelines

CONNECT WITH US



SECTIONS

- News
- Videos
- Armed Citizen

IN THE SPOTLIGHT

- Awards and Scholarships
- NRA Membership
- NRA Women's Leadership Forum
- Refuse to be a Victim®
- NRA Women on Target
- NRA School Shield
- Eddie Eagle GunSafe® Program

NRA MEMBERSHIP

- NRA Membership
- Exclusive Member Benefits
- Membership FAQ
- Manage Your Membership



EXPLORE MORE NRA PUBLICATIONS



The NRA Women's Leadership Forum Is The Fastest Growing Community Within The NRA



Exclusive SPECIAL OFFER For Women Only: Women Make The NRA Stronger, JOIN Today!



NRA Family Is For Beginning Shooters Of All Ages Designed To Provide An Introduction To The World Of Shooting And Recreation



If You Are New Or Have Been Shooting For Years, Check Out These NRA Women's Special Interests



FREE SHIPPING & FREE RETURNS*

All Search by product, brand, category, deal or all of the above

SEARCH

SHOPPING CART

- DEALS
- OPTICS
- GUN PARTS
- AMMO
- SHOOTING
- HUNTING & FISHING
- GUNSMITHING & RELOADING
- OUTDOOR & SURVIVAL
- APPAREL & FOOTWEAR
- MILITARY & TACTICAL
- POLICE, FIRE, EMS
- MORE...
- NEW

Get 2% Bucks on Most In-Stock Ammo, Plus Free Shipping!*

STOCK UP

*Get Free Value Shipping on most orders over \$49. Restrictions and exclusions apply. See details.

All Reviews > Maglula Reviews + Shooting Accessories Reviews > Maglula Shooting Accessories Reviews + Speed Loaders Reviews > Maglula Speed Loaders Reviews >

Reviews & Ratings for Maglula UpLULA Universal Pistol Magazine Speed Loader — 170 reviews

★★★★★ (170 reviews)



Maglula UpLULA Universal Pistol Magazine Speed Loader

As Low As \$29.99 Save Up to 23%

VIEW PRODUCT

WRITE A REVIEW

Add to compare

Most Helpful Positive Review

Must have in range bag

★★★★★

Along with your pistol, ammo and mags, you need to have the Maglula UpLula loader in your range bag. It will save you time and your thumb. This is one of the most useful accessories you will own. Easy to use and takes up very little space and light weight. Pick it up, use it, you won't leave home without it. Get some!

Filter by

All

Showing 1 - 10 of 169 reviews

Sort by

Newest First

Show

10

Fast & Simple

★★★★★

by ChefRick, from OR, United States Written on August 18, 2023

Easy to use and load at the range. I'm using a Sig P365 and usually reload 200 rounds. This is my 2nd one as I have misplaced the 1st one. Have used other loaders but this is the GOLD STANDARD.....m

Pros:

- Easy

Cons:

- none can see

Would recommend: Yes

Was it helpful to you? Yes | No

REPORT ABUSE

SHARE

Mag speed loader

★★★★★

by Goofy, from MS, United States Written on August 13, 2023

Saves you fingers from manual loads however, tracking the package gets a BIG FAT ZERO! No way to track the order unless you call customer service. If your in a hurry for the item it's a force pay, they are so slow in delivering the product to you. They get a zero for that also. Product is good though.

Pros:

- Good item as what it's for

Cons:

- Slow "shipping"(emal code)

Best Used for:

- Reload mags

Would recommend: Yes

Was it helpful to you? Yes | No

REPORT ABUSE

SHARE

UpLula loader

★★★★★

by gunquy, Verified Owner from TN, United States Written on August 7, 2023

I have arthritis and have trouble topping off some magazines. The UpLula is simply a great product! Best loader in my 60 years of shooting! Worth the extra few bucks and work on all guns- single stack or double stack!

Would recommend: Yes

Was it helpful to you? [Yes](#) | [No](#)

[REPORT ABUSE](#) [SHARE](#)

A Must Have

★★★★★

by [Lucky](#), Verified Owner from MN, United States Written on August 3, 2023

These are probably the most useful thing to have at the range or anywhere you are shooting. These will save your thumbs and hands from soreness. Who ever invented these should get the noble peace prize. These make loading ypur magazines super easy and super fast.

Pros:

- easy to use
- small and compact

Cons:

- None

Would recommend: Yes

Was it helpful to you? [Yes](#) | [No](#)

[REPORT ABUSE](#) [SHARE](#)

Great invention

★★★★★

by MV, from MA, United States Written on July 26, 2023

To add to thousands of great reviews, this is the first time I've owned one of these, primarily got it for students in my classes. It really is a nifty invention. Fast, efficient, compact, can load quick and empty a magazine quicker. Anyone that shoots double stack magazines needs one of these.

Pros:

- Works great

Cons:

- None

Would recommend: Yes

Was it helpful to you? [Yes](#) | [No](#)

[REPORT ABUSE](#) [SHARE](#)

fast charger

★★★★★

by Rafael, from PR, United States Written on July 5, 2023

Excelent piece for fast reload. It works is 9mm and 40mm very well. Fast shipping to PR and excellent customer service. This is my second item in different color.Excelent piece for fast reload. It works is 9mm and 40mm very well. Fast shipping to PR and excellent customer service. This is my second item in different color.

Pros:

- Fast reloading

Cons:

- any

Would recommend: Yes

Was it helpful to you? [Yes](#) | [No](#)

[REPORT ABUSE](#) [SHARE](#)

Maglula Uplula loader

★★★★★

by Bob, from OH, United States Written on June 6, 2023

Works as advertised.No more sore thumb or mangled up feed lips on my magazine.very well built.Happy about this product and would recommend it to anyone.works slicker than any of the competitors .Wish I had this years ago .easy enough for the grandkids to use.

Pros:

- Work as advertised

Cons:

- A little pricey

- Works as a

Would recommend: Yes

Was it helpful to you? [Yes](#) | [No](#)

[REPORT ABUSE](#) [SHARE](#)

Best speed loader on the market

★★★★★

by Oldcdawg, from IA, United States Written on May 2, 2023

This speed loader is fast and easy to use. It works with every gun that I own and wasn't too expensive. I loaded every clip that I own just to test it out. It will save your fingers. Highly recommend.

Would recommend: Yes

1 of 1 found the following review helpful.

Was it helpful to you? [Yes](#) | [No](#)

[REPORT ABUSE](#) [SHARE](#)

This is a hand saver.

★★★★★

by [Scott Allen](#), Verified Owner from CA, United States Written on April 17, 2023

Loading magazines with the Uplula is a breeze. As I have aged, loading is a challenge and has become painful. My hands no longer hurt for days after loading. I have tried other loaders with little success. Single stack or double stack, it doesn't matter. This just works.

Pros:

- Works with all my center fire pistols.

Cons:

- None

Would recommend: Yes

Was it helpful to you? [Yes](#) | [No](#)

[REPORT ABUSE](#) [SHARE](#)

Great product

★★★★★

by Smooth, from AL, United States Written on March 20, 2023

Makes loading mag easier and less painful on the fingers. Very convenient for speed loading at range or home defense. Great product, fast delivery too. I would definitely approve of this for anyone who has multiple magazines to load quickly,,, if necessary

Pros:

- Quick loading

Cons:

- None

Best Used for:

- Range
- Home defense

Would recommend: Yes

1 of 1 found the following review helpful.

Was it helpful to you? [Yes](#) | [No](#)

[REPORT ABUSE](#) [SHARE](#)

Page
[Back](#) [1](#) [Next](#)

Showing 1 - 10 of 169 reviews

Get 10% Off - Subscribe to Our Email List

Sign up and get exclusive access to promotions, sales events, pre-order sales & more!

SUBSCRIBE

Or, modify

Customer Service

[Help Center](#)
[My Account](#)
[Check Order Status](#)
[View My OP Bucks Balance](#)
[Returns & Exchanges](#)
[Shipping Policy](#)
[Request for Quote \(RFQ\)](#)
[Contact Us](#)

Why Buy From Us

[Unmatched Shopping Experience](#)
[Free Shipping](#)
[Earn OpticsPlanet Bucks](#)
[Top Rated Mobile App](#)
[Military & Medical Professional Discount](#)
[Win Awesome Gear](#)
[Customer Testimonials](#)

Information

[About OpticsPlanet](#)
[GearExpert Blog](#)
[Partnership Inquiry](#)
[News & Press](#)
[Jobs & Careers](#)
[Our Online Stores](#)
[Dvor.com - Daily Deals Site](#)
[New Supplier Inquiry](#)

Contact Information

Toll-Free: +1-800-504-5897
Intl.: +1-847-513-6201
Fax: +1-866-534-3097
Email: sales@opticsplanet.com

Hours of Operation

9AM-5:30PM CT Mon-Fri

Our Guarantees



[Mobile Site](#) | [iOS App](#) | [Android App](#) | [Accessibility](#)

© Copyright 1999–2023 OpticsPlanet, Inc. | [Our Policies](#) | [Privacy Notice](#) | [Show Web ID](#)

Protected by Google reCAPTCHA | [Privacy](#) | [Terms](#)



Home > Gear & Accessory Reviews > Best Pistol Magazine Speed Loaders [Hands-On Tested]

Best Pistol Magazine Speed Loaders [Hands-On Tested]



Want to save your thumbs AND your time loading magazines? We hands-on test four of the most popular magazine speed loaders out there and crown our winner.

BY DAVID LANE, UPDATED JULY 10, 2023 | 28 COMMENTS | BOOKMARK

-
-
-
-
-
-

Trending: [Best Ammo in Stock](#), [Best AR-15](#), & [Best 9mm Pistols](#)

SUMMARY OF OUR TOP PICKS

EDITOR'S PICK	BEST FOR CLASSES OR COMPETITION	FASTEST LOADER
 <p>MagLula Pistol Magazine Loader</p> <p>Easy to use and a lifesaver for your thumbs on the range</p> <p>\$33 at Gunmag Warehouse</p> <p>Read Review</p>	 <p>Caldwell Universal Pistol Magazine Loader</p> <p>Easy to use while standing, no table needed, best for competition events or classes where tables aren't readily available</p> <p>\$23 at Amazon</p> <p>Read Review</p>	 <p>ETS CAM Pistol Speed Loader</p> <p>Loads a lot of rounds at once, so it saves time</p> <p>\$22 at GrabAGun</p> <p>Read Review</p>

Maybe you have soft thumbs, maybe you load dozens or hundreds of magazines a month, or you just want to save some time.

No matter the reason, many of us have found that magazine loaders are a **really handy thing** to keep in your range bag.



Maglula and 9mm Ammo

But with so many on the market, you might want to know which ones are really worth the cash. We tested some of the most popular loaders on the market and have the full run-down for you!

BEST PISTOL MAGAZINE SPEED LOADERS



1. Maglula Uplula

Simple, easy to use, and fairly cheap.

While this speed loader isn't the coolest-looking one we tried, it is one of the best.

And is, in fact, our personal favorite.

You should know, though, that this is actually our second Uplula, the first one we ran until it died after loading **more than 20,000 rounds**. In our opinion, that is one respectable service life.





Maglula Uplula

The design and use are simple; just place it over the magazine, squeeze the handle, and push down.



This depresses the follower or last round in the magazine and lets you drop a new one on top. Release the lever and pull up to reset the loader for the next round.

It's intuitive and provides a lot of force, even for really sticky magazines. Best of all, it works with zero adjustments for a huge range of magazine types and calibers.



Maglula Pistol Magazine Loader

We've used the same loader for .380 up to .45 ACP, from Glock to Beretta to Wilson Combat 1911 magazines – the same loader worked for all of them with equally successful results.





MagLula Pistol Magazine Loader

\$33
at Gunmag Warehouse

Prices accurate at time of writing

\$33 at Gunmag Warehouse

Gunmag Warehouse (See Price)
OpticsPlanet (See Price) ✂

I would also recommend this loader for anyone that has pain in the wrists or hands since it requires minimum force to use and is easy to gain leverage on.

What's your take on the Maglula? Rate it below!

Readers' Ratings

★★★★★
5.00/5 (1145)

Your Rating?

☆☆☆☆☆

SUBMIT RATING

2. Caldwell Universal Pistol Magazine Loader

BONUS: Shoot better. Download our exclusive shooting targets for FREE (\$47 value)

The amount of engineering that went into the Caldwell Magazine Loader is nothing short of impressive.



Caldwell Universal Pistol Magazine Loader

Caldwell is known for making great gear, and their magazine loader keeps that tradition alive. It isn't as intuitive as the Uplula, but once you see how the bits work, it is easy to use.

Our Most Popular Posts



8 Best Compact 9mm Handguns



8 Best AK-47 Rifles of 2023: Complete Buyer's Guide



8 Best AR-15 Flashlights [Real Views]



Best AR-15 Complete Upper Receivers 2023

Set the spacer for your magazine (instructions are provided with the loader), insert the magazine, tighten the set screw, and simply load each round into the window before using the staple-gun-like handle to load the round into the magazine.



THE BEST GUN DEALS, COUPONS AND FINDS

Subscribe to Pew Pew Tactical's sales and deals email.

SUBSCRIBE

This is really handy if you have limited space, such as at a training class, a busy range, or a competition event.

Since the Caldwell loader doesn't require the use of a table or bench to brace yourself on, this is easy to use just standing and loading.

BEST FOR CLASSES OR COMPETITION



Caldwell Universal Pistol Magazine Loader

\$23
at Amazon

Prices accurate at time of writing

\$23 at Amazon

The handle is also large enough that it provides a ton of leverage, making the squeeze much easier than one might expect.

3. ETS CAM Speed Loader

Loading one round at a time can be a fairly speedy process once you get used to it, but it is limited by the fact that it is still only **one round** at a time.

ADVERTISEMENT

Enter the ETS CAM Speed Loader.

Able to load a full magazine at a time, the ETS combines the use of your ammo boxes with your loader to make the process a LOT faster.



Use the tray to slide over the cartridges while they are sitting in your ammo box to pre-load them and set them in place over your magazine.

Use the provided T-Handle to then push and guide the rounds down into your magazine.



This takes more force than other loaders, and it's a bit hard to get the right leverage when using a table.

We actually found that employing a seppuku-esq style of bracing the magazine against the sternum and pulling the T-Handle to the body actually worked better than trying to brace it all on the table.



New to guns? Check out our online [Beginner Handgun Course](#) that teaches all the important stuff you need to know.

While not a very comfortable way of using the ETS CAM, it was effective.

Besides, bruises are good for you.

And if you're cool enough to wear a plate carrier while loading your magazines, you wouldn't feel a thing!

FASTEST LOADER



The image shows the ETS CAM Pistol Speed Loader, a black plastic device used for loading handgun magazines. It has a T-shaped handle and a magazine inserted into it. Several brass rounds are shown falling from the magazine into a small pile on the surface below.

ETS CAM Pistol Speed Loader

\$22
at GrabAGun

Prices accurate at time of writing

\$22 at GrabAGun

[GrabAGun \(See Price\)](#)
[Amazon \(See Price\)](#)

If you really want speed or you're trying to load large-capacity magazines, the ETS CAM really does save a lot of time over some of the other methods.

4. MagPump

We only had one problem with the MagPump – **it broke the first time we tried to use it...**

After watching the 5.56 version of the MagPump in action at competition events and media range days, we can say firsthand that it *can* work very well.

But sadly, the 9mm version we tried to test broke the first time we tried pumping the handle.



One pump and SNAP, the MagPump was dead.

It is unlikely that this was a user error, and not a lot of force was used when pumping the lever. This was likely a defect in the manufacturing that manifested itself when we tried to use the lever.

If we get our hands on a new one, we'll give it another test. But based on this result so far – we can't really recommend it for anything.

That said, if you'd like to try out the 5.56 version of the MagPump...



MagPump

\$149
at GrabAGun

Prices accurate at time of writing

\$149 at GrabAGun

[GrabAGun \(See Price\)](#)
[Brownells \(See Price\)](#) ✂

FINAL THOUGHTS

There are a lot of other magazine loaders on the market, and we'll be testing more eventually, but of the ones we've tested – the winner was clearly the **MagLula Uplula**.



So many rounds, so little time.

Simple, easy to use, and minimal moving parts that might break down.

EDITOR'S PICK



MagLula Pistol Magazine Loader

\$33
at Gunmag Warehouse

Prices accurate at time of writing

\$33 at Gunmag Warehouse

[Gunmag Warehouse \(See Price\)](#)
[OpticsPlanet \(See Price\)](#) ✕

To see these in action, check a video we did a while back on them!



Primary Arms SLx 1-6x24 Gen IV Review: Best Budget LPVO?

Deals of the Day:

Hand-Picked Ammo & Firearm Discounts



HOLOSUN 407A3 X2 REFLEX SIGHT, 3 MOA – \$179.99

AUG 27, 2023

[SEE ALL DEALS](#)

MagLula Pistol Magazine Loader



Caldwell Universal Pistol Magazine Loader





What magazine loader do you use? Let us know in the comments! And if you want more awesome pistol goodness, take a look at our [Editor's Picks!](#)

Related topics: [Buyer's Guide](#), [Gear Reviews](#), [Pistol](#), [Review](#)

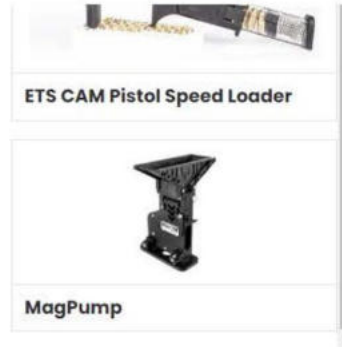

Related Articles



Best AK-47 Magazines [Hands-On]



Best AR-15 Magazines: Standard, High-Capacity, 10-Round



5 Best Ruger 10/22 Magazines [Plus Loaders]



Can You Store Loaded Magazines Long-Term?

Explore More Pew Pew Tactical



Best AR-15 Scopes & Optics for 2023: Red Dots to Magnified



Best 10mm Pistols & Handguns: Go Big or Go Home



6 Best AR-10s: Complete Buyer's Guide



Best Glock Upgrades [Hands-on]: Defense, Competition, & Custom

Powered by [Contextly](#)

Written By



[David Lane](#)

Learning how to shoot at a young age in the Boy Scouts, David now spends most of his time working on or with firearms. Be it shooting, upgrading, building, tinkering, or writing about them - sharing his passion and knowledge of firearms with others is an everyday occurrence. [Read more...](#)

28 Leave a Reply

Join the discussion



Chuck Cochran

One Loader Maker I don't see on the list is Makershot. Makershot makes loader specific to each gun. Their model for the P365, I find superior to the Maglula. Their Beretta 92 works better than Beretta's loader. Their not terribly expensive either, as most models are under \$20.

July 11, 2023 6:41 pm [REPLY](#)

👍 0 🥰 0 😂 0 😱 0 😭 0 🚫 0



John

When I have lots of magazines to load, I give some of the neighborhood kids (with parents permission) \$10.00, the magazines, crate of ammo, sit them down in the garage and let them go at it while I go have a sandwich and watch TV.

July 10, 2023 5:53 pm [REPLY](#)

👍 0 🥰 0 😂 0 😱 0 😭 0 🚫 0



Mark

The only complaint I have about the Maglula is the safety lock as a lefty, I often accidentally lock it while loading.

July 10, 2023 3:27 pm [REPLY](#)

👍 0 🥰 0 😂 0 😱 0 😭 0 🚫 0



Tim Taylor

I bought the Maglula a year ago or so, so much easier than fighting those last couple rounds especially after spending part of a day at the range. I highly recommend this loader.

March 12, 2022 1:10 pm [REPLY](#)

👍 0 🥰 0 😂 0 😱 0 😭 0 🚫 0



Dan in Idaho

I've used, bought, given, lost, found (in an old bag or back behind the bench) the Maglula forever and have never really thought of any alternative. Anyone at the range with me or nearby that has n't seen one before loves it and asks about it and sometimes I'll give them one (which is when I usually lose my other, then buy another). Right now I think I have 4 of them (maybe 5). It's just there and always works and I never think much about it. If you don't have one yet, get one.

January 17, 2022 2:48 pm [REPLY](#)

👍 0 🥰 0 😂 0 😱 0 😭 0 🚫 0

[LOAD MORE COMMENTS](#)

Shoot Better

Get Our Top Shooting Drills and Zeroing Targets (\$47 value - but FREE for a limited time).

And stay in touch with newsletters of our best articles on techniques, guns, & gear.

Your Email Address

GET IT NOW!



[PRIVACY POLICY](#) - [TERMS OF USE](#) - [DISCLAIMERS](#) - [ABOUT US](#) - [ADVERTISING](#) - [SCHOLARSHIP](#)

I may earn a small part of the sale from links to any products or services on this site. You do not pay anything extra and your purchase helps support my work in bringing you more awesome gun and gear articles.

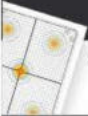

Want Free Practice Targets?
Get our 9 favorite targets and drills

Copyright © 2023 Pew Pew Media, Inc. All rights reserved.





Firearms Guide TEST: The LULA & UpLULA Magazine Speedloaders

Details

Published: 11 January 2022

NEWS PAGE

Sign up for our newsletter

- Daily Digest
- Monthly Newsletter

Email address

SIGN UP NOW



Los Angeles, CA - (FirearmsGuide.com) – The LULA & UpLULA Magazine Speedloaders are easy to use, effective, and affordable speedloaders that will save your thumb and make a great day at the range even better.

Recently I was training on the range and after loading the magazine several times I decided that I finally have to “upgrade” my mag loading style. Why load the mags with your bare hands and torture your thumb? I decided to buy several Lula speedloaders and this is my experience with them.

The Lula speedloaders were invented in 2000 by Ran and Guy Tal (father & son) from Israel where they are still manufactured today. They founded the Maglula company (www.maglula.com) in 2001 and started mass production of their first product AR15 LULA loader and unloader. They own several International Utility Patents, Trademarks, and Copyrights for their speedloaders.





This is Baby UpLULA speedloader for pistol magazines in calibers from 22LR to 380 ACP

Since then, they developed many different speedloaders and they currently provide several product families:

- LULA rifle magazine loader & unloader – a personal single-round loader and unloader.
- UpLULA pistol magazine loader – a personal pistol magazine loader.
- StripLULA 10-round stripper clip and loose rounds loader and unloader.
- BenchLoader 30-round heavy-duty single-stroke magazine loader.
- X10-LULA magazine loader – a non-locking loader & unloader for mags with a side button.
- V10-LULA magazine loader – a locking loader for mags with a side button.



1. Slide a magazine into the speedloader



2. Squeeze the mechanism on the side of the Uplula



3. Push down the Uplula loader



4. Insert the new round, release the Uplula and repeat

1. Ease of use & effectiveness: LULA, UpLULA, and Baby UpLULA magazine speedloaders are super simple and easy to use and very effective mag loaders. To use any of them, just slide an empty magazine into the speedloader. Once the magazine is fully seated, squeeze the mechanism on the side of the Uplula while pushing down on the UpLULA loader. This force causes the Uplula's press to engage the magazine follower, moving it downward and allowing a round to easily slip into the magazine. When the round is in place, release the side

mechanism and pull up on the device to allow the follower to naturally move back into place.

Even the magazines with big capacity and hard spring can be easily loaded to the last round because you don't push rounds down with your thumb. Instead of torturing your thumb and scratching it on the sharp magazine lips, you simply push down the UpLULA loader with the weight and strength of your whole arm and then you just slide in another round. Your fingers are protected at all times.

You will appreciate how much time and pain you will save even if you are young and healthy. If you are an older shooter with weaker hands that UpLULA speedloaders are a must for you. We also recommend using them in cold weather that can be harsh on your hands too.

See UpLULA loading & unloading demo here:

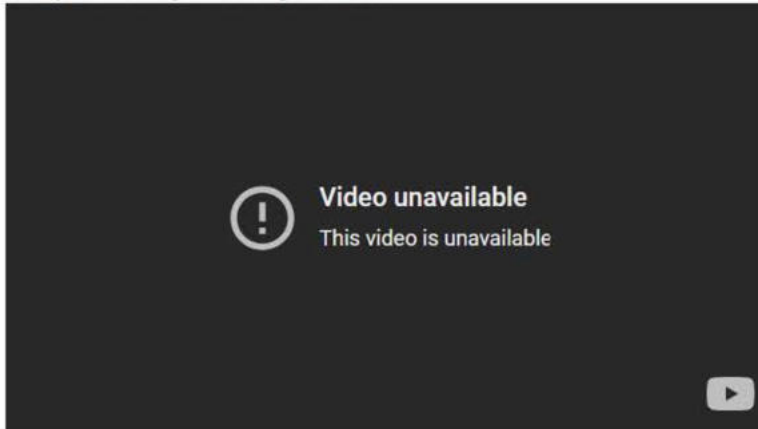

2. Speed of use: Right out of the box, it took me probably 20 seconds to load my 10 round mag but with more practice, I become better. Many of you will load one round per second. I have zero ambition to break a world speed record in magazine loading. For me, it is only important that loading is easy and painless. Easy magazine loading means less pain and more fun at the range.

3. Production quality: Maglula magazine speedloaders are known for military-grade, top-quality production, and quality control. They are made from very strong polymer and steel, in black, pink, dark green, orange-brown, lemon green, purple and US-flag. They are sturdy but light. The weight is only 66 grams (2.3 Ounces). They are designed very well with functionality as a priority. I like their simple design. It looks like there is nothing that could break there.





4. Unloading feature: There is a channel along the back of the UpLULA and a small raised portion of plastic that pushes against the back of the first round in the mag. The small lip allows you to easily push the round forward and out from under the feed lips, exactly how the magazine is designed to function. Once you get the motion down, you can empty a fully loaded fifteen-round magazine very quickly. Again, your fingers are 100% protected while unloading.

5. Magazine compatibility: Maglula has speedloaders for any magazine. 1911, Glock, Sig, single stack magazines, double stack magazines, Ruger Rotary Magazines, AR15,the best thing is to go over to www.maglula.com and check it out yourself. I liked the most UpLULA universal 9mm to 45ACP pistol magazine speedloader that can load any pistol single or double stack magazine.

Universal UpLULA pistol loader loads the following mags: Astra, Auto-Ordnance, Barak, Beretta, Browning, Bul, Colt, CZ, EAA, FN, Glock, HK, Hi-Point, High Standard, Jericho, Kahr, Kel-Tec, Kimber, Les Baer, Llama, Luger, Magnum Research, Para-Ordnance, Phoenix Arms, Ruger, Sigma, Sig/Sauer, S&W, Springfield Armory, Star, Steyr, Taurus, Vector, Walther, and more. Please check which loader you need for your magazine here:
<http://www.maglula.com/faq>



These are Maglula loaders for 30-rounds 223 Remington AR rifle magazines and one that I need the most - loader for Ruger 10/22 on the right

We found an interesting fact on the Maglula website. Maglula Ltd. does not sell online or on Amazon and eBay. They only sell to local gun shops and big gun-friendly retail stores. You can find a list of them at www.maglula.com. The reason is probably because of low-quality Chinese knockoffs of patented UpLULA universal pistol magazine loaders are often offered for sale online. Some of these Chinese knockoffs are very similar to original Maglula loaders, deceptively having 'UpLULA' and 'Made in Israel' embedded in them and packed in blisters similar to Maglula's.

Conclusion: If you would like to painlessly load your magazines to the very last round and enjoy shooting & training more, then UpLULA loaders are a great solution. Effective, simple,

fast, light, reliable, and affordable solution to the unpleasant work of loading your pistol or rifle magazines. I could not even imagine loading 30-round AR magazines without LULA loaders.

To get one please go to the Maglula website: <https://www.maglula.com>

[← Prev](#)

[Next →](#)

NEWS LINKS

[ABOUT OUR NEWS SERVICE](#)

[SUBMIT NEWS](#)

[SUBSCRIBE TO NEWS](#)

[NEWS SERVICE TERMS OF USE](#)

Firearms Guide News Service

Welcome to FirearmsGuide.com News Service where we publish news, press releases, product reviews and announcements of our **Advertisers** and/or **Online Edition paid subscribers**. Sign up for our newsletter and always be informed on shooting sports news.

COPYRIGHT © 2007 - 2023
IMPRESSUMEDIA LLC





3

4



5



3

WILEY X REMINGTON BRAND SHOOTING GLASSES

New glasses made by Wiley X and carrying the Remington brand come in several versions intended for different shooters. They're available in a more top-of-the-line Platinum package and a consumer-friendly Shooter line. Each one of the Platinum shooting glasses meet ANSI Z87.1 high-mass and high-velocity impact safety and optical standards, as well as EN 166 safety certification for OSHA-grade protection when shooting and hunting.

The Adult Platinum package includes five lens colors: smoke, clear, yellow, persimmon and purple. The Female package includes smoke, clear rose and yellow lenses, while the Youth/Jr. kit includes smoke, clear and yellow lenses.

The Shooting line is available in Adult and Female frame styles providing ANSI Z87.1 and EN 166 safety ratings and 100 percent UV protection. Adult models are offered in a choice of black/green frame with either smoke lenses or clear lenses. Female models feature stylish gray/pink frames with smoke or clear lenses.

MSRP on the Adult Shooting Line glasses is \$59.99.

WWW.WILEYX.COM

Write No. 103 on Header Service Card

4

MAGLULA UPLULA PISTOL LOADER

It's a fact of life: when your customers throw lots of lead downrange, they have to load lots of lead into their magazines.

That can be a time-consuming proposition when lane fees come into the picture or shooters are frantically topping off their mags before another stage in a competition.

With the UplLULA pistol magazine loader from Maglula, your customers can cut that load time in half and save their fingers from blisters and cuts when they're getting ready for the next round.

The UplLULA is a military-grade universal pistol magazine loader and unloader designed to work with virtually all 9mm Luger up to .45 ACP magazines, single- and double-stack and 1911s of all manufacturers. It will also load most .380 ACP double-stack mags.

Made from a tough polymer plastic, the UplLULA fits in any range bag and weighs only 2.5 ounces.

The Maglula UplLULA comes in a wide range of colors and retails for about \$30.

WWW.MAGLULA.COM

Write No. 104 on Header Service Card

5

SEAL 1 CLP PLUS

It seems like everywhere you turn there's a new gun cleaner or solvent that's billed to change the world and make every shooter a special ops sniper.

One product that's definitely not snake oil is the SEAL 1 CLP Plus from SEAL 1 LLC. Founded by — you guessed it — former SEAL Dwight Settle, SEAL 1 CLP is nontoxic and safe to use because it has no petroleum products, ammonia, vegetable oils or vegetable esters, so it will not attack metal or dry out and get gummy.

Better yet, it will not adversely affect barrel life because it contains no abrasives or other ingredients that might pit your bore. In fact, the stuff is a USDA-Certified biobased product and, yes, some of the contents are a closely held company secret.

SEAL 1 CLP is a liquid that's easy to apply to a firearm part such as a gas system component with a patch or brush or directly from the bottle. It also works in cold environments — as low as minus 50 degrees Fahrenheit.

A 4-ounce bottle of SEAL 1 CLP Plus retails for \$12.95.

WWW.SEAL1.COM

Write No. 105 on Header Service Card

GEAR & GADGETS FOR 2018

By Kevin Reese

If you've ever attended a SHOT Show, you'll likely agree the event can be overwhelming. With hundreds of thousands of products on display, getting to all of them is an exercise in futility — honestly, any attempt would essentially be doomed from the start. So, industry media guys like me undertake the often difficult task of weeding out and presenting to you

those products we believe offer great bang for your retailer buck — products worthy of room in your inventory and of interest to prospective customers brightening your business' doorstep. Check out this healthy array of gear and gadgets hand-picked to increase your retail traffic.



3M Peltor Sport Tactical 500 Electronic Hearing Protector

When it comes to hearing protection, listen to a guy with constant ringing in both ears and significant hearing loss — this IS important stuff! In a world where ear-pro costs can skyrocket, I was incredibly impressed with the sub \$200 price point of 3M Peltor's Sport Tactical 500 Electronic Hearing Protector. The Sport Tactical 500 features a 26 dB noise reduction rating, 3M Smart Technologies, Clear Voice Tracking for enhanced hearing, Dynamic Suppression Time to optimize shooting and environment noise cancellation, Bluetooth wireless technology to synch operation with your smartphone, intuitive buttons and voice guidance, recessed mics for reduced wind noise and low-profile cups with cutouts, perfect for rifle and shotgun shooting. MSRP \$160. www.3m.com

Maglula UpLULA Universal Pistol Mag Loader

Maglula's patented UpLULA 9mm to .45 ACP Universal Pistol Mag Loaders have garnered a lot of attention in the handgun world. While scores of caliber-specific magazine loaders get the job done, Maglula's universal loader is compatible with all calibers between 9mm and .45 ACP, including single- and double-stack magazine systems, and is a must-have for your handgunning customers. New for 2018, Maglula added several colors designed to let your customers' tastes shine through. The new colors include pink, dark green, orange-brown, lemon and purple; of course, black is also still available. The UpLULA comes in at a price point of \$35.

www.maglula.com



Caldwell Precision Turret

Few products stopped me in my tracks like the Caldwell Precision Turret. Whether your customers simply enjoy target shooting or need a solid micro-adjustable system for precise zeroing, they are sure to appreciate a truly affordable precision-turret tripod system that at an MSRP of \$129.99, costs less than many premium bipods. The Caldwell Precision Turret keeps your rifle locked in place with a full range of swivel, pan and tilt motion. Additional features include a quick-deploying, twist-locking, carbon-fiber legs; M-Lok and keymod adapters and up to 180 degrees of leg angle adjustability. The Caldwell Precision Turret is certain to draw major attention once they start showing up on firing lines. MSRP \$129.99.

www.blibrands.com/brands/caldwell



What dealer resources are you looking for?

SEARCH

** DEALERS: U.S. FIREARMS REPORT 2023 **

SHOOTING
INDUSTRY

FIRST LOOK DISCOVER DEALER ADVANTAGE INDUSTRY NEWS GUNS VIDEOS SUBSCRIBE



ACCESSORIES

AMMUNITION

CARRY OPTIONS

FIREARMS

GUN CARE

KNIVES

SIGHTS & OPTICS

FAMILIAR FAVORITES CONTINUE TO RESONATE

WRITTEN BY MELISSA PORTER

FIRST LOOK | ACCESSORIES | WOMEN'S PRODUCTS |
2020

1



Through its Lead & Lace Ladies shooting group, Georgia Gun Club has developed a significant base of regular customers. Light-shooting .22s are an early favorite of new shooters, according to General Manager Beth Martin.

In the Feb. 2020 issue, we explored the impact of new-for-2020 products on the female segment of the industry (*Arms & The Woman*, “New Products Ready For Plinking, CCW Or Hunting”). While stocking fresh products geared toward women represents a more than capable approach to bring in this burgeoning group of customers, there’s also nothing wrong with sticking with the tried-and-true.

“It’s all the old favorites that still attract women,” said Bren Brown, co-owner of Frontier Justice with locations in Lee’s Summit, Mo. and Kansas City, Kan.

What are some of these favorites?

“UpLULA Speed Loaders, firearms with a nice grip — like the Smith & Wesson Shield — leggings able to hold firearms and conceal-carry purses that look like actual stylish ones,” she continued.

Brown has made a concerted effort to ensure women feel welcome at both of her establishments, which feature a dedicated fashion boutique.

“Our boutique is a huge *‘WELCOME’* sign to women coming to our store,” she shared. “It’s the same with hosting a date night, women’s-only classes and having a sales staff that takes the extra time to treat everyone with dignity and respect — whether they’re talking to a beginner or an advanced shooter.”

Frontier Justice hosts several “Date Night” packages throughout the year, with Valentine’s Day the most recent. It includes a lane rental for two, one firearm rental, two boxes of ammo, dinner, a rose, eye protection (to keep) and a photo opportunity. Members receive a significant discount.

Bren revealed an unexpected trend: “It’s the woman who buys Date Night, rather than the man — which has surprised us.”

www.frontierjustice.com

Range Visits

Boasting Georgia’s only 100-yard indoor rifle range, Buford-based Georgia Gun Club has been successful in its efforts reaching out to women. General Manager Beth Martin informs those who do come in for a visit don’t often arrive alone.

“The women we see shooting long guns on our 100-yard indoor ranges definitely have more experience shooting,” she said. “They usually come with the family, spouse or boyfriend to shoot as opposed to by themselves to work on pistol shooting.”

Matching Brown’s earlier observation, Martin earmarked the Maglula UpLULA as a perennial favorite for customers.

“The UpLULA magazine loader is a must for any range bag,” she contends. “We have them available to use on our ranges, and women grab them up after they’ve used one. Plus, we have them in many colors so they don’t get lost in a range bag.”

Touted in the aforementioned February article, the GLOCK 44 has been an early contender for women at the Georgia Gun Club.

“The GLOCK 44 has really done well with our female market,” Martin added. “We have so many new shooters to the industry who start with Georgia Gun Club. This addition of a reliable .22-caliber pistol is a plus to get them started with learning the basics.”

www.georgiagunclub.com





HNR Co-Owner Hillary Dube and Manager Lora DeMaio showcase the Maglula UpLULA. Dube shared she keeps them on the front counter to capitalize on add-on purchases, while leaving a model out for demos. “[They’ve] flown off the shelves!” she added.

All-Women Meetup Thrives

Hillary Dube, co-owner of HNR Gunworks in Inverness, Fla., opened her store mid-2017 and has already cultivated supportive ties within her community. A new monthly endeavor is providing further opportunities for her store to propagate a positive message of the shooting sports.

“We started a Women’s TEAM (Training, Education, Action, Meetup),” she explains, “taught by our female NRA instructor Sabrina Watson. We’ve had such a great turnout of women shooters — novice to competition shooters who enjoy the sport and camaraderie!”

The meetups include safety information, conversations about Florida’s concealed carry laws, live shooting and more.

When asked what prompted her interest in facilitating an all-women’s group, Dube answered: “I think it’s so important to offer a chance for women to get together, learn and support each other, especially in these politically trying times where it can be frowned upon.”

To promote the HNR Women’s TEAM, Dube also launched a Facebook page. It’s also well positioned to provide natural tie-ins to developments at her store. TEAM events attract a wide range of women, even creating powerful mother-daughter experiences.

“We have women from age 11 to 87, and I enjoy watching them grow and enjoy the sport,” she shared. “I think these groups will continue to be an emerging trend.”

While there is a fee involved for those attending the event, Dube also referenced another way they impact her store’s bottom line: prospective customers can get acquainted with products already in stock at HNR Gunworks.

“These events allow us to introduce Flashbang holsters and UpLULAs, and other handy products that are useful at the range and for carry!” she exclaimed.

Of note here: the mention of the Maglula UpLULA was unprompted in each of our three interviews — so, something to keep in mind as you place your next order. Dube explained the rise of popular compact pistols necessitates sales of speed loaders.

“In single-stack pistols like the SIG P365, those last few rounds are nearly impossible to load — unless you have a speed loader,” she said. “UpLULAs have *flown* off the shelves for both new and veteran shooters alike. They should be in every range bag!”

www.hnrgunworks.com

What tried-and-true product lines are resonating with your segment of female customers? Share with the *SI* team, and be featured in a future issue!



[Click To Read More Shooting Industry April 2020 Issue Now!](#)

FIRST LOOK | ACCESSORIES | WOMEN'S PRODUCTS |

2020

1

[f Share](#) [t Tweet](#) [p Pin](#) [e-mail](#) [Share](#)

WE THINK YOU'D BE INTERESTED IN THIS, TOO





ICYMI: INDUSTRY...



News from around the firearms industry, Aug. 21–25, 2023, featuring Pyramyd AIR, Partner With A Payer, Kimber and more ...

[READ FULL ARTICLE](#)



BRAVE...



September is National Suicide Prevention Awareness Month. Perhaps this time of year, over any other, would be the time to emphasize brave conversations with...

[READ FULL ARTICLE](#)



FOCUS ON "MAKING..."



Customers are most satisfied when you reduce their effort and remove obstacles to getting what they want. Smooth, efficient transactions are more likely to...

[READ FULL ARTICLE](#)

DEALER ADVANTAGE

SIGN-UP TO RECEIVE SPECIAL CONTENT, NEWS, OFFERS, AND MORE!

ENTER YOUR EMAIL ADDRESS

SUBMIT



VIDEOS
ADVERTISING
MISSING ISSUE

SUBSCRIBE
CONTACT

ABOUT
ADDRESS CHANGE



HANDGUNNER

GUNS

MADE BY **SIDEKICK**

Access 2,549 GUN DEALS, click here and save big \$\$\$ >>

Home > Buying Guides > The 4 Best Glock Speed Loaders

BUYING GUIDES GEARS GLOCK

The 4 Best Glock Speed Loaders



BY BEAU - SEPTEMBER 4, 2022 - 6 MINUTE READ



We love finding tools and gadgets that really streamline the process of using a gun. This applies to every aspect, from loading to shooting, to cleaning.

We've compiled this review of the best Glock speed loaders.

GGD Universal Pistol Speed Loader



TOP PICK

- ✔ Compact and portable
- ✔ Durable, long-lasting construction
- ✔ Easy to use
- ✘ More manual than others

\$11



Shop Now

Click to read my review

RAE Industries Double Stack Magazine Loader



- ✔ Nearly universal
- ✔ Light and slim
- ✔ Sturdy construction
- ✘ Requires gentle use

\$8



Shop Now

Click to read my review

MakerShot Custom Magazine Speedloader



- ✔ Custom fit to your Glock
- ✔ Very durable polymer
- ✔ Very smooth use and function
- ✘ Not universal in any way

\$12



Shop Now

We may earn a commission when you purchase through the links on our site. Find out more [here](#).

Join 212,000+ readers

Gun deals, hand's on reviews, educational content and news on law changes, every day!

Enter your email

Subscribe >

By checking this box, you agree with our Privacy Policy.

Table of Contents

- 2 Glock Magazine Speed Loader
- 3 RAE Industries Double Stack Magazine Loader
- 4 MakerShot Custom Magazine Speedloader
- 5 Maglula UpLula Universal Pistol Magazine Loader
- 6 Our Favorite Glock Speed Loader

Editor's Picks



Best 9mm Ammo in 2021 [Self-Defense & Target]

BY MIKE · 13 MIN



Best Concealed Carry Insurance in 2022

BY MIKE · 8 MIN

[Click to read my review](#)

Maglula UpLula Universal Pistol Magazine Loader



- ✔ Truly universal
- ✔ Sturdy construction gets the job done
- ✔ Solid build
- ✘ expensive

\$32



[Shop Now](#)

[Click to read my review](#)

 **Rifle Calibers [Ultimate Guide]**
BY MIKE · 18 MIN

 **6.5 Creedmoor vs .243 Win - Cartridge Comparison**
BY HUSTON · 32 MIN

 **Handgun Calibers [Ultimate Guide]**
BY MIKE · 31 MIN

There are actually quite a lot of Glock speed loaders that you can choose from online. While price can be a factor in your decision, speed loaders shouldn't cost you much money in general. We believe the biggest deciding factor in choosing the best Glock speed loaders is whether or not you have other pistols you'll want to use a speed loader for. Choosing between a universal or a custom speed loader is the best way to get a cost-efficient product.

BONUS OFFER: Get your free shooting range targets to print at home!

Buyer's Guide to the Best Glock Speed Loaders

These are some things you need to consider before purchasing a 9mm speed loader.

Correct Type of Speed Loader

The first step is to ensure that you use the appropriate speed loader for the magazine and caliber. You don't want to have anything too big or small because this could cause operation and loading rounds issues. Don't assume a speed loader is ubiquitous because it's labeled that.

Check the Durability

Durability is the second factor. In general, you do get what you pay for. So if you're choosing a magazine loader, you might choose something dependable and durable.

Reliability

Finally, pick an option that fits your needs. This means you should get something you can squeeze rather than push down if you are not particularly strong or have hand arthritis. On the other hand, if you are strong and have no problems using your hands, you can be more flexible in finding something that suits you well.

The main thing to remember is just getting somethingâ€”you'll need it, and your hands will appreciate it.



Glock Magazine Speed Loader



Materials — The Glock Magazine Speed Loader for 9mm Mags is the only option within this review that is actually manufactured by Glock. Of course, there is also an option available made by Glock for your 10mm weapons. However, this 9mm option will obviously be the more commonly purchased one.

The design is factory bulk packed, but it's made with the same Glock polymer the company uses on its weapons and other accessories. The sides have a raised texture, so your hands won't slip if they happen to be a little sweaty. This 9mm option will work with most Glock models, including 17, 19, 22, 23, 25, 26, 27, 28, 31, 32, 33, 34, 35, 37, 38, and 39.

Performance — This speed loader is a tool that allows you to load rounds quickly and efficiently. One of the best things about Glock speed loading is how quick and simple it is to use. Once you acquire a grip on how to use this equipment, you won't need to put in as much effort to line up the rounds in the tray. It will still save you time overloading them one by one. This speed loader works great as range magazines making it a valuable addition to your gun and very useful.

What we say — The Glock Magazine Speed Loader is a fantastic choice. It is simple to use without any parts that might break, and it is very affordable. This is the speed loader for you if you want to make the magazine loading process as simple as possible.

Pros

- ✔ Compact and portable
- ✔ Durable, long-lasting construction

Cons

- ✘ More manual than others

✔ Easy to use



GGD Universal Pistol Speed Loader

\$11
at Gun Gear Depot

SEE IT

RAE Industries Double Stack Magazine Loader

Materials — The RAE Industries Double Stack Magazine Loader is a highly demanded option online, and it happens to be offered in a variety of colors including black, blue, glow in the dark, nuclear green, orange, pink, purple, ruby red, and yellow. While not necessarily universal, it fits a variety of bullet diameters from 9mm/ .35 caliber to 11.43mm/ .45 caliber.



It should be compatible with all Glock models but, if you own other pistols, some popular styles it works with are Beretta, Colt, Luger, Ruger, Sig, S&W, Taurus, Walther, and a handful of others. Very little force is required with this option, so delicate (or at least not forceful) hands are all that are required to utilize it.



Performance — The RAE Industries Double Stack Magazine Loader, while not totally universal, is pretty dang close to being universal. At the minimum, it should have your Glocks covered. We appreciate the slimmer

design than some other speed loaders, simply because it's easier to hold and store away.

The construction is certainly more stable than many other plastic or polymer loaders. The color options aren't really important to us, but that could be fun for some (glow in the dark, anyone?). Despite the sturdier construction, the manufacturers do point out that not a lot of force is needed, and we agree with them.

What we say — The RAE Industries Double Stack Magazine Loader is one of the best Glock speed loaders for those who prefer a slimmer design and are hoping to get more use out of their purchase with other pistols.

Pros

- ✔ Nearly universal design
- ✔ Lightweight and slim
- ✔ Sturdy construction

Cons

- ✘ Requires gentle use



RAE Industries Double Stack Magazine Loader

\$8
at Amazon

SEE IT

BONUS OFFER: Get your free shooting range targets to print at home!

MakerShot Custom Magazine Speedloader



Materials — The MakerShot Custom Magazine Speedloader is similar in



appearance to the previous option (minus the selection of wild colors, it only comes in black). However, this one is custom-made to your specific Glock model instead of touting it as universal or near-universal.

Currently, the available models of this speed loader are for Glock 17, 19, 21, 22, 23, 27, 30, 34, 35, 36, 42, and 43. Simply put your 9mm, .40, and .380 caliber Glocks. You will get an incredibly smooth experience since every speedloader is fit for your handgun. The construction is made of a tough polymer, as opposed to a more flimsy plastic, and the shape is fairly ergonomic as well.

YOUR FIRST LINE OF DEFENSE IS A GOOD NIGHT'S SLEEP

Advertisement
SUB SEAR DEPOT
\$100 VOUCHER
WITH EVERY MATTRESS

30% OFF
SHOP NOW

Performance — The MakerShot Custom Magazine Speedloader seems almost exactly like the RAE Industries option but is much more unique to your Glock. You’re receiving a custom fit guaranteed to be perfect for your handgun, but you also have to purchase more than one if you want a speedloader for more than one firearm. That point aside, the construction is more stable than the polymer Glock option at the beginning of this review. Sorry, guys, no fun colors to pick from here, but we think you’ll manage.

What we say — The MakerShot Custom Magazine Speedloader is the best Glock magazine loader for those who only require this tool for maybe one or two pistols. Otherwise, your shopping cart will get really expensive really fast.

Pros

- ✔ Custom fit to your Glock
- ✔ Very durable polymer construction
- ✔ Very smooth use and function

Cons

- ✘ Not universal in any way



MakerShot Magazine Speed

Loader

\$12
at Amazon

SEE IT

Maglula UpLula Universal Pistol Magazine Loader

Materials — The Maglula UpLula Universal Pistol Magazine Loader is easily one of the most popular and well-reviewed speed loaders on the market today. It is also one of the only truly universal options you can purchase. The construction is made of plastic, and it's only available in black.



This option works for both single stack and double stack loading and is advertised to be compatible with all 9mm, 10mm, .357, .40, and .45 magazines, as well as all 1911 mags. Using it doesn't even require you to press their bullets in. You only need to drop it in place. This option is a fitting shape to be pushed into a pocket and carried with the user wherever needed.

Performance — We had to include the Maglula UpLula Universal Pistol Magazine Loader in this review because it is clearly the most popular online. With over tens of thousands of positive reviews, we'll put in our two cents too. This is the only option within this review that is really universal.

If you own multiple pistols or even multiple Glocks, then this is the best choice for you. We don't like how significantly more expensive this option is — it's almost twice as much (or more) as all the other speed loaders we've considered. We suppose it's worth the money if you get the proper use out of it. This option worked pleasantly well with all the Glocks we tested it out on, so no complaints on the function.

What we say — The Maglula UpLula Universal Pistol Magazine Loader is the best choice for those who are going to get their money's worth and use it with more than one or two pistols.

YOUR FIRST LINE OF
DEFENSE IS A GOOD
NIGHT'S SLEEP

Advertisement
SUN SEAR
DEPOT
\$100 VOUCHER
WITH EVERY MATTRESS

30% OFF
SHOP
NOW

Pros

- ✔ True universal design
- ✔ Sturdy construction that will last

Cons

- ✘ Twice as expensive as others

long
✔ Works well with all Glocks



Maglula UpLula Universal Pistol Magazine Loader

\$32 at GunMag Warehouse	SEE IT
\$29 at Gritsports	SEE IT
\$35 at Sportsman's Guide	SEE IT

Our Favorite Glock Speed Loader

All of these are good Glock speed loaders, and if one catches your eye, then go with that one. My top pick is the [Glock Magazine Speed Loader](#). I like the simplicity of this one with virtually no extra parts that can jam or break. While almost 1/2 the price of the Maglula, it is only one or two more dollars than the others. I personally think that is worth it to get the branded product for my beloved Glock.

You might also like to read:

- [The 4 Best Glock 26 Sights](#)
- [9mm Glock Models \(Ultimate Guide\)](#)
- [The 4 Best Glock Sight Tools](#)

[Share](#) [Tweet](#) [Pin](#)

Join 212,000+ subscribers!

Get gun deals, hand's on reviews, educational content and updates on law changes, daily! Unsubscribe at any time. No spam.

Subscribe >

By checking this box, you agree with our Privacy Policy.

Author

Beau



Beau has collected guns since he was 21. His father taught him hunting, bullet casting and reloading, which lead him to develop a strong passion for guns and gun gear. After serving in the military, Beau got himself even more guns. Today, he loves to shoot and write about his weapons. He shares most of his passion with other gun enthusiasts here on Sniper Country. Beau has also trained with the USCCA and is a current member.

[View Comments \(1\)](#)

Related Posts



BUYING GUIDES, GEARS, SHOTGUNS

Best Shotgun Lights

For tactical or self-defense reasons, having a shotgun light on hand may be necessary for circumstances when the lighting is not good. An enemy invading your home is probably doing so at night, and a shotgun tactical light attached to your firearm can be a lifesaver. A good light attachment should not only illuminate whichever ... [Read more](#)

BY BEAU



BUYING GUIDES, OPTICS & SCOPES

The 4 Best 1-4X Scopes

There are a variety of shooting applications that a 1-4X variable powered scope can be a perfect match. A large number of tactical rifle users enjoy having a variable powered scope rather than using more open or CQB sights. A lot of hunters also prefer a 1-4X powered scope in the field rather than a ... [Read more](#)

BY BEAU



AR-10 AND AR-15, BUYING GUIDES, GEARS

Best 6.5 Grendel Uppers

Have you ever looked at your AR-15 and wished that it just had a little more Power. Defending yourself from four-legged threats, harvesting game, or punching steel at really long distances — you just need a little more power sometimes. Thankfully, you can have it. If you're not sure what the hype is about 6.5 ... Read more

BY DAVID LANE



BUYING GUIDES, GEARS, MOSSBERG

Best Mossberg 500 Barrels [2022]

If you're a proud owner of one of America's favorite shotguns, then you've experienced the Mossberg 500's flexibility and reliability firsthand. It was favored by both civilians and the US military. So, how could you say no to making an already good shotgun, better? The best way to improve the performance of your Mossberg 500 ... Read more

BY BEAU 6 SHARES

Join 212,000+ subscribers

Get gun deals, hand's on reviews, educational content and updates on law changes daily! Unsubscribe at any time. No spam.

Enter your email

Subscribe >

By checking this box, you agree with our Privacy Policy.



[Privacy Policy](#) [Cookie Policy](#)

[Contact Us](#) [Terms of Use](#)

[About Sniper Country](#)

© 2021 SniperCountry.com



THANK YOU FOR SUPPORTING VETERAN JOURNALISM - JOIN SOFREP+ →



NEWS MEMBERS ONLY PODCAST BOOK CLUB BOOKS STORE ADVERTISE



FIREARMS ACCESSORIES

UpLULA Pistol Mag Loader | Quick Look

by Erik Meisner Jun 12, 2017

SHARE THIS: [Facebook] [Twitter] [LinkedIn]



Anyone who spends a fair amount of time training with firearms knows the dreaded task of magazine loading. It's one of those things that abuse your thumbs and hands. But it's also a necessary evil that we partake in to better prepare ourselves when arriving at the shooting range. Because time is precious, I like to have as many magazines pre-loaded into my [5.11 Range Ready Bag](#) as I plan to shoot while training that day. Additionally, it helps save time and keep things organized once I arrive on site. So the day before, I typically upload all pistol and rifle magazines. Speeding up this process is the UpLULA from Maglula.

Known for their efficient and well-built up loaders, Maglula produces several variations for most popular pistol and rifle magazines on the market. Ranging from [AR's](#) to [AK's](#). Submachine guns and most [pistol mags](#), Israeli based [Maglula](#) is on-station to save your thumbs from the tedium of magazine loading. The UpLULA universal pistol magazine loader is a robust unit, utilizing high quality material ensuring years of trouble-free use. As you can see in this short video, the UpLULA is a must-have item to add to your range bag.

MOST READ

- 1 Revolutionizing Naval Warfare: The USS Zumwalt's Hypersonic Upgrade
- 2 Beyond the Myth: The True Influence of Ninja Warriors in Feudal Japan
- 3 SERE Instructor: Why the Daniel Defense MK18 is so popular
- 4 Vietnam War Origins: How the Domino Theory Fueled US Intervention
- 5 SOFREP Breaking News: Three US Marines Die in Australian Training Exercise

SOFREP+ ARTICLES

- Revolutionizing Naval Warfare: The USS Zumwalt's Hypersonic Upgrade
- On the Brink: Understanding West Africa's Recent Spate of Coups
- Vietnam War Origins: How the Domino Theory Fueled US Intervention



North Korea Plans Satellite Launch: A Renewed Attempt Following a Previous Setback



US Navy Seeks Advanced Uncrewed Undersea Vehicle Detection and Tracking Technologies



RECENT COMMENTS



Russ S. - I have never heard of ingesting small pieces of C4 and never had any issues with toxic fumes from he...

The Evolution of C4: A Journey from Battlefield to Civilian Use - 2 days ago



Russ S. - "In all history there is no war which was not hatched by the governments, the governments alone..."

Vietnam War Origins: How the Domino Theory Fueled US Intervention - 2 days ago



Bluto25 - Force Protection Measures takes another step forward. 🙌

US Navy Seeks Advanced Uncrewed Undersea Vehicle Detection and Tracking Technologies - 2 days ago



Joseph P. - Awful article. Drive!

Vietnam War Origins: How the Domino Theory Fueled US Intervention - 2 days ago



UpLULA details courtesy of maglula.com

- Loads all* 9mm Luger, .357 Sig, 10mm, .40, and .45ACP cal. single and double stack magazines., including 1911 mags, of all manufacturer, and also loads most .380ACP single and double-stack mags.
- Pocket-size. One size fits all. No inserts, spacers or adjustments at all !
- Easy loading; the rounds just drop in with no thumb pushing or pressing.
- No more pain ! Load hundreds of rounds painlessly.
- Protects your fingers and mags.
- Up to one round per sec. loading rate. 1/3 the time loading several mags with thumb.
- Fits in hand and pocket, weighs only 72 grams (2.55 Ounce).
- Highly durable.
- Purchase [here](#) for \$34.95

Due to an overwhelming supply of counterfeit UpLULA products infiltrating the US market, Maglula has issued this warning as well as recommendations for trusted resellers:

Low quality Chinese counterfeit loaders cloning our patented UpLULA™ universal pistol magazine loaders are offered for sale on Amazon and eBay. Commingling (mixing) of genuine and counterfeit loaders in the same Amazon bin may result shipping of counterfeits. Please refrain from ordering loaders at Amazon or eBay until further notice. If you suspect receiving a counterfeit loader, please take few pictures of packaging and loader and send it to info@maglula.com. We'll let you know counterfeit or genuine. Please shop at local gun stores you trust and from companies we ship to direct: [Brownells](#), [MidwayUSA](#), [Cabela's](#), [BassPro](#), [Dick's Sporting Goods](#), [Turner's](#), [CheaperThanDirt](#), [Sportsman's Guide](#), [ShopRuger](#). Be cautious of counterfeits at weekend gun shows and markets. Some Chinese knockoffs are very similar to our own deceptively having 'UpLULA' and 'Made in Israel' embedded in them and packed in blisters similar to ours.

Items pictured in video: [5.11 Range Ready Bag](#), [Howard Leight Sport Impact Earmuffs](#), [Agency Arms Glock 34](#), MTM Special Ops Vulture watch.

Gear up with The New SOFREP Tactical Store! Shop now and get the best gear handpicked by Navy SEALs, Army Special Forces, Rangers, USMC MARSOC, and Air Force Special Ops.

[SHOP NOW](#)

SHARE THIS: [f](#) [t](#) [e](#) [in](#) [p](#) [+](#)

ABOUT ERIK MEISNER



Erik Meisner served in Attack Company, 2nd Battalion 75th Ranger Regiment as a rifle team leader with deployments to the Middle East, Central America and Asia. He's a licensed pilot, SCUBA diver and enjoys Alpine skiing, travel, sea kayaking, Overland exploration and golf. Growing up in a

[Read More](#)

[View All Posts](#)



Stephen P.

The leadership crisis isn't because of Tubbsville. It has been decades in the making, and brou...

The Pentagon's Leadership Crisis: Abortion Policy Standoff Leaves Military Branches Without Leaders · 3 days ago

Sign up for the SITREP

Get Frontline News & Global Topics Right Into Your Inbox

Enter your email address

[Subscribe](#)

Your opinion matters, submit an Op-Ed today

[SUBMIT](#)

SOFREP AUTHENTIC GEAR

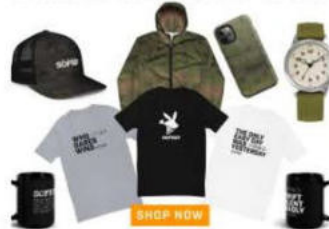

EDITOR'S PICK



Preserving Democracy: The Dangers of Weaponizing the American Legal System



SOFREP Stands With Our Brothers Who Demand Responsibility for 'Disastrous' Afghan Departure

Get The Daily Situation Report

Never miss a breaking story and have your finger on the pulse at all times by signing up the SITREP.

SIGN ME UP

For signing up, we'll send you some completely FREE training videos where you can watch Navy SEALs and other Spec Ops train for combat.



Adam Brown: A SEAL's Life of Courage and Redemption



Complete List: Ticonderoga-class Missile Cruisers To Retire By 2027



Nuclear Close Calls That Nearly Caused World War III

Join SOFREP Team Room for Insider Access and Analysis

Your Subscription Supports our Veteran Staff

SUBSCRIBE NOW



Think Dental Implants Are Expensive In Washington? Think Again (See Prices)

3,424



"One drop makes me so productive, I get a days work done in 3 hours"

51,098



Prepper: Thinking Of Solar Panels? Try This Instead, It's Genius!

630



Heart Surgeon Begs Americans: "Stop Putting This In Your Coffee"

16,239



A Doctor From Washington Shared How To Remove A Hanging Belly!

8,204



SHOCKING: Major U.S. Asset Destroyed By Idiotic Biden Move

23,385

Sponsored Ad

MORE FROM SOFREP



SIG MPX LULA | Magazine Loading Made Easy



JTT: Use the Right Tool



Range Bag Tools: MagLuLa Loader



Maglula Lula Loaders



StripLULA AR Magazine



StripLULA AR Magazine

Review – Load Like a King

Loader: Spend More Time Shooting, Less Time Loading

Loader: Spend More Time Shooting, Less Time Loading

COMMENTS

You must become a [subscriber](#) or [login](#) to view or post comments on this article.

Recommended for you

Recommended by 



Urologist: 92% of Men with ED Don't Know About This Easy...

Sponsored | [urologytip.pro](#)



[Photos] 35 T-shirt Fails That Went Too Viral

Sponsored | [Cars And Yachts](#)



This Is How The Cast of Gilligan's Island Has Turned Out

Sponsored | [Pens & Patron](#)



Urologist: 92% of Men with ED Don't Know About This Easy...

Sponsored | [urologytip.pro](#)



[Photos] People Who Wore The Wrong T-Shirt At The Right Time

Sponsored | [Cars And Yachts](#)



This Is How The Cast of Gilligan's Island Has Turned Out

Sponsored | [Pens & Patron](#)



Diabetes Is Not From Sweets! Meet The Main Enemy Of Diabetes

Sponsored | [bloodysugar.online](#)



Forget the Blue Pill; Just Take This Once Daily

Sponsored | [urologytip.pro](#)



[Photos] We Can't Not Laugh At These Hilarious T-Shirt Fails

Sponsored | [Cars And Yachts](#)



Russian Soldier Castrates Ukrainian POW: Posts it on Telegram Social Media



The Art of Survival: Understanding Military Unarmed Combat Techniques



Diabetes Is Not From Sweets! Meet The Main Enemy Of Diabetes

Sponsored | bloodsugar.online



Forget the Blue Pill; Just Take This Once Daily

Sponsored | urologytip.pro



[Photos] People Who Wore The Wrong T-Shirt At The Right Time

Sponsored | Cars And Yachts

VETERAN-FRIENDLY COMPANIES



PYRAMYD AIR

Our mission is to help all of our customers rediscover the outdoors through delivery of stellar products, knowledge and service, ensuring safety and guaranteeing limitless enjoyment. Our No. 1 goal is to make sure YOU have the right product for YOUR needs.

Our roots in shooting sports started off back in 1996 with our founder and CEO, Josh Ungier. His love of airguns took hold of our company from day one and we became the first ecommerce retailer dedicated to airguns, optics, ammo and accessories. Over the next 25 years, customers turned to us for our unmatched product selection, great advice, education, and continued support of the sport and airgun industry.

- ✉ support@pyramydair.com
- ☎ 888-262-4867
- 🌐 Visit Website
- 📍 5135 Naiman Parkway Solon, OH 44139



BARRETT FIREARMS

Barrett is the world leader in long-range, large-caliber, precision rifle design and manufacturing. Barrett products are used by civilians, sport shooters, law enforcement agencies, the United States military, and more than 75 State Department-approved countries around the world.

- ✉ media@barrett.net
- ☎ 615-896-2938
- 🌐 Visit Website
- 📍 PO Box 1077 MURFREESBORO, Tennessee 37133 United States



RECPAK

RecPak is a meal replacement for the outdoors that saves you weight, space and time in the most challenging environments, just add water.

- ✉ hello@recpak.co
- 🌐 Visit Website
- 📍 P.O. Box 378 Red Hook, New York 12571 United States



OAKLEY

Oakley was created for world-class athletes, those who see the limits of possibility as just another challenge. Their dedication drives us to look beyond the conventional ideas of industry standards.

800 403 7449

Visit Website



**JOIN THE SOFREP 300 AND TAKE YOUR PLACE
AMONG VETERAN FRIENDLY COMPANIES TODAY.**

LEARN MORE

US MILITARY RANKS



SO F R E P

MEMBERS ONLY NEWS MEDIA BOOK CLUB BOOKS PRESS ACCESS SOFREP 300 STORE SIGN-IN

FOLLOW US



OAKLEY

Oakley was created for world-class athletes, those who see the limits of possibility as just another challenge. Their dedication drives us to look beyond the conventional ideas of industry standards.



Search the store



Sign In Register



0 Cart

TEAM SPICETAC

ABOUT US

REVIEWS

BLOG

BUY AMMO ONLINE

BUY GUNS ONLINE

GEAR RECOMMENDATIONS

SWAG

FREE SHIPPING

Free Standard Shipping Orders Over \$99

FREE SHIPPING

LOGIN For Member Pricing if Available

HOME / BLOG / MAGLULA UPLULA SPEED LOADER REVIEW

CATEGORIES

- AR15 Upper Parts >
- AR15 Lower Parts >
- AR10 Parts >
- Favorite Brands & Products >
- Toolcraft BCG Sales
- Inbound Products
- SpiceTac Swag

POPULAR BRANDS

- Aero Precision Products
- Ballistic Advantage
- Radian Weapons
- Toolcraft
- SpiceTac
- Magpul
- FailZero
- Palmetto State Armory
- Spikes Tactical
- View All



Maglula UpLULA Speed Loader Review

The Maglula UpLULA Universal Pistol Magazine Speed Loader. Funny name, great product!

Loading pistol magazines isn't a chore - until it is. For any number of reasons you might want to use a magazine loader to help with this chore.

If your magazines are new and have stiff springs, you may want a Maglula.

If your hands are fatigued, you may want a Maglula.

If you are loading a whole bunch of magazines at once, you may want a Maglula.

If you need to load a bunch of mags in a hurry, you will definitely want a Maglula UpLULA!

What is a Maglula UpLULA? Read on!



RECENT POSTS

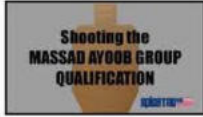

Shooting The Massad Ayoob Group MAG Qualifier

What is the MAG Qual? The Massad Ayoob Group (MAG) Qual is ...

[Read More](#)



10 Best Places To Buy Ammo Online [2023]

If you like convenience, selection and low prices, you owe it to yourself to shop online ...

[Read More](#)



Top 5 AR15 Bolt Carrier Groups

The bolt carrier group is the heart of your AR15. Let's look at some of the best! There a ...

[Read More](#)



[Read More](#)

Trending: [Buy Guns Online](#), [Best Handguns for Beginners](#)



The Maglula UpLULA is one of the best magazine loaders on the market

What is a Maglula Speed Loader

UpLULA stands for Universal Pistol Loader and Unloader Accessory. It makes loading magazines fast and easy. Start by placing the UpLULA over a pistol magazine. Then simply squeeze the handle and press down. This will push the top round down making room for the new round that you are about to insert. Repeat this process until you have a full magazine. It is easier to do than it is to explain.

Testing the Maglula UpLULA

In late 2022 and early 2023 I shot approximately 10,000 rounds through a Dan Wesosn 9mm 1911 pistol. I was shooting the [Massad Ayoob Group \(MAG\) Qualification](#) and was going for a perfect score.

From the beginning I used a Maglula UpLULA mag loader to fill the magazines and I was glad that I did! Some days I would shoot as many as 500 rounds in one range trip. The shooting was fast and difficult and I was glad that my hands were not unnecessarily fatigued from loading tons of magazines.



Best Handguns:
Beginners & Home
Defense [2023]

What's the best
handgun for a beginner?
How about the best
home defense pistol?
It's best ...

[Read More](#)



Where To Buy Body
Armor Online
[2023]

Shopping for body
armor online? There are
many good online stores
to choose from. Check
...

[Read More](#)



Buy Guns Online |
Best Online Gun
Store | Best Gun
Websites

Better selection, better
prices. That is why I buy
guns online and you
should too! There ...

[Read More](#)



Maglula UpLULA
Speed Loader
Review

The Maglula UpLULA
Universal Pistol
Magazine Speed Loader.
Funny name, great
product! Lo ...

[Read More](#)

The Maglula UpLULA has a permanent spot in my range bag

Previously I was using the UpLULA to load 9mm Glock magazines. I was very surprised when I discovered that it would also work perfectly for the single stack 1911 magazines I was using!

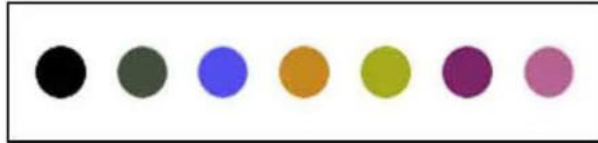

The UpLULA is available in a variety of colors



Maglula UpLULA Speed Loader

\$ 34.95

[See at Brownells](#)

Prices Subject To Change

I have always loaded magazines by hand and actually originally purchased the UpLULA for my wife and daughter to use. They loved it but I never thought it would be something that I would use. Boy, was I wrong. When the shooting got fast and heavy I was glad that I had it! I think you will be too.

Verdict: Highly Recommended

Trending: [Best Handguns for Beginners](#), [Ammo in Stock](#)

Mar 24, 2023 SpiceTac

Recent Posts

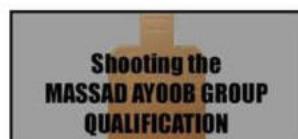



Installing a Difficult AR15 Firing Pin Retaining Pin

Taking things apart is easy. Putting them back together can sometimes be a nightmare. If ...

[Read More](#)



Best 380 Ammo for Self Defense & Target Shooting [2023]

380 ACP (Automatic Colt Pistol), also known as 9x17mm, 9mm Browning, 9mm short... and th ...

[Read More](#)



Dan Wesson Pointman 1911: 15,000 Round Review

The 1911 pistol is an American icon and Dan Wesson makes some of the best! The pistol we ...

[Read More](#)



Shooting The Massad Ayoob Group MAG Qualifier

What is the MAG Qual? The Massad Ayoob Group (MAG) Qual is ...

Read More [May 27, 2023](#) [David "Blaze" Blazek](#)

10 Best Places To Buy Ammo Online [2023]

If you like convenience, selection and low prices, you owe it to yourself to shop online ...

Read More [May 20, 2023](#) [SpiceTac](#)

Top 5 AR15 Bolt Carrier Groups

The bolt carrier group is the heart of your AR15. Let's look at some of the best! There a ...

Read More [May 13, 2023](#) [SpiceTac](#)

* SpiceTac is a participant in the Amazon Services LLC Associates Program and other affiliate advertising programs. We may earn a small commission from products advertised on SpiceTac. At no cost to you this helps us to continue to offer our own great products at great prices. Thank you for your support.

Subscribe to our newsletter

Your email address

SUBSCRIBE



Navigate

- Shop SpiceTac Amazon
- Track Button
- Visit SpiceTac
- Home
- FAQs
- Blog
- Contact Us
- Privacy Policy
- Terms of Service
- Shipping & Returns
- Sitemap

Categories

- AR15 Upper Parts
- AR15 Lower Parts
- AR10 Parts

Popular Brands

- Aero Precision Products
- Ballistic Advantage
- Radian Weapons
- Toolcraft
- SpiceTac
- Magpul
- FailZero
- Palmetto State Armory
- Spikes Tactical
- View All



© 2023 SpiceTac | AR-15 Parts.



5.0 ★★★★★
Google
Customer Reviews



MODULAR SAFES YOU CAN MOVE YOURSELF

Home > Gear Review > The One and Only Pistol Magazine Loader I Recommend

Gear Review

The One and Only Pistol Magazine Loader I Recommend

By Dan Zimmerman - September 29, 2018 40

Like 0



Previous Post

I'm asked fairly frequently which mag loader I use, if any. I just got another email asking about that, hence this post. Some gun owners look down on magazine loaders, but I'm not amongst that group. I'm on board with anything that makes range time easier and more efficient.

Next Post

It's not really worth a full-blown product review, but I do have an easy answer to the question: It's the [Maglula UpLULA](#) (you can get one for [\\$35 via Brownells](#) or a few bucks less [at Amazon](#)). My UpLULA has saved me a LOT of thumb pain loading tens of thousands of rounds over the years.

Advertisement

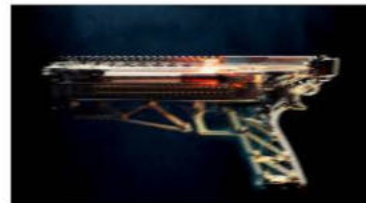

Keeping you empowered and informed...

Sign Up For FREE Today

Email (required):

First Name:

ZIP Code:

Sign Me Up!

Categories

Select Category

It may seem a tad expensive for what it is, but I've tried them all and you won't regret buying one. The UpLULA is solidly built, a pleasure to use, and it's compatible with both double and single stack pistol mags in 9mm, .357 SIG, .40 S&W, 10mm, and .45 ACP, as well as some .380 mags. Pretty much any pistol mag that's not a .22LR.

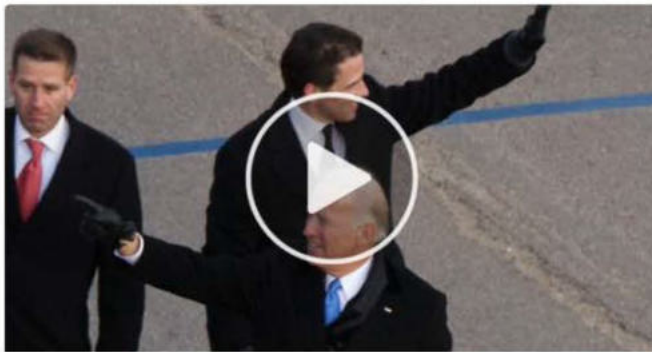

Nancy Pelosi Wants This Video Destroyed — Watch Now Before It's Banned

Watch The Video

Watch The Video

229,450

Sponsored Ad

Note: the UpLULA does NOT work for .45 ACP 6-round GLOCK mags or 7-round 9mm S&W mags, but that's about all it won't do. I've been recommending the Maglula as a great gunny stocking stuffer for years and haven't yet found a reason to stop. Highly recommended.

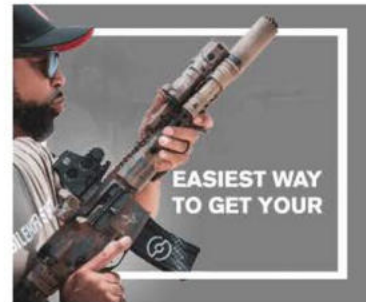

Around the Web



Doctor: New Knee Sleeve Helps Millions with Bone-on-bone Knee Pain

Compressa



Ringing Ears? Doctor: when Tinnitus Won't Stop, Do This (Watch)

Stop Tinnitus



Why Your Firewood Needs This Drill Bit?

Dotmalls

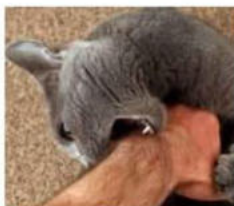

Around the Web



Gutter Guards for One-story House: How Much Would It Cost?

LeafFilter Partner

If Your Cat Bites You, Here's What It Really Means

Factable



Swimsuit Moments That Made Waves on the Big Screen

History Obsessed

20 Kitchen Appliances That Are a Waste of Money, Ranked in Order

Money Pop



Here's The Average Price Of Gutter Protection In The U.S

LeafFilter Partner

[Photos] Camping Photos That Captured Too Much

Reportingly



[This revolutionary drill bit is talking District of Columbia by storm in 2023!](#)

[Dotmalls](#)



"It Worked Too Well" Tinnitus Cure Previously Banned Makes A Comeback

Stop Tinnitus

Recommended For You



The Cheapest Way to Firearm Train in 2023 Using the Strikeman Laser Training System

[Previous Post](#)

[Next Post](#)

TAGS [maglula](#) [maglula uplula](#) [pistol magazine loader](#) [uplula](#)

[Like 0](#)

[Previous article](#)

[Chinese Restaurant Robber Gets Bullets With His Egg Roll](#)

[Next article](#)

[Giveaway Alert: Massive Uinta Trading Co. Promotion](#)



[Photos] Camping Photos That Captured



This Isn't Your Grandpa's Thc - It's Way Stronger!

HelloMood



This "1" Knee Sleeve Has Knee Surgeons Speechless

Compressa





Dan Zimmerman

<http://www.thetruthaboutguns.com>

Heart Surgeon Begs Americans: "Stop Doing This To Your Fruit"

Gundry.MD

RELATED ARTICLES

MORE FROM AUTHOR

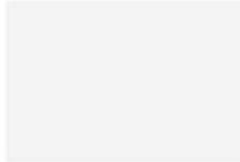

Gear Review: Mission First Tactical's New Achro EDC Backpack Series

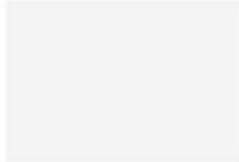

Gear Review: Area 419 Harris Bipod ARCALOCK Clamp Kit

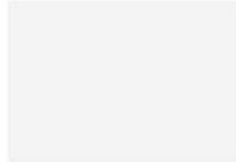

Optic Review: Primary Arms SLX 3-18x50mm FFP Rifle Scope With Illuminated ACSS Athena BPR MIL Reticle



40 COMMENTS



Juice September 29, 2018 At 14:19

I am unable to comfortably top off my nearly-new M&P Shield mags without one of these. They work great.

Reply



Draven September 29, 2018 At 14:22

Several mag dumps will make the Shield mags better, or load them and leave them sitting... but even then, I prefer the UpLULA for range trips

Reply



J September 29, 2018 At 14:21

A maglula was the first thing I bought after buying my first pistol. Ten pistols and 8 years still don't use anything else

Reply



Snake Plisskin September 29, 2018 At 18:59

You got that right. I've ended up with 2 of them now; one that I keep; in range bag all the time. Also their AR and AK loaders work just as well.

I ended up getting one and giving it a friend of my wife's for her to use with her G19. She loves it.

Reply



NEIL December 8, 2018 At 11:01

They're great! I bought two. Then I just stopped using them. Some is I have great hand strength and I developed technique and muscles to the point I just didn't care; some is because my mags are now well loved. 😊 However, if you are starting, buy one! I gave mine away to

friends learning how to shoot that I gave an introduction to.

Reply



Markd September 29, 2018 At 14:28

coming in multiple colors can make them easy to find, available in 2 sizes the BABY UpLULA which is for .380 ACP and smaller. Then the standard, with an adapter it makes the single stack simple and without the double stacks I love these and share with others at the range. First time I say them was used by Hickock45 saw how fast and easy the mags were loaded.

Reply



Laserbeam September 29, 2018 At 14:32

I have a couple of Maglula's, one for double stack and another for single stack. Very handy especially for new mags with stiff springs. On another note, they won't work with PMR-30 mags either. AND, Caldwell has a pretty slick loader as well.

Reply



Whoopie September 30, 2018 At 15:52

I have a LULA and it works with both double and single stack mags. But I recently bought the Caldwell mag loader and OMG!!! That gizmo makes loading mags fun. You just pop the cartridge into the loading port and squeeze the handle and kerplunk. I was at the range yesterday and it took about 15 seconds to load an 18 rd. mag. Works with single and double stacks of any caliber (not rimfire) and you can find them on Amazon and ebay for \$35, about the same price as the LULA.

Reply



Blowing September 29, 2018 At 14:36

An Uplula, a hand full of snap caps and a quick demonstration is all I ever needed to sell these things to customers. They all but sell themselves. I've assured many a customer, "if you pull one of these out of your range bag and use it for a moment - the person in the lane next to you will ask to borrow it."



Reply



16V September 29, 2018 At 23:04

I was sold at a gunshow years ago by a gent who tossed the bullets in a mag with the aplomb of a three card monte pro. 17 rounds in under 10 seconds...

I love mine. Multiple mags are nice, but being able to reload them in seconds after shooting hundreds of rounds is priceless.

Reply



Centuriator September 29, 2018 At 15:04

Watch out for Chinese fakes on these. Make sure they are actual Maglulas.

Reply



Porridgeweasle September 29, 2018 At 15:51

Ya, those Magruras suck.

[Reply](#)



any democrat September 29, 2018 At 19:42

rahis!

[Reply](#)



GluteusMaximus October 27, 2018 At 10:22

Ha ha ha

[Reply](#)



Cucamonga Jeff September 29, 2018 At 15:10

I prefer the small fingers of children to load my mags before a range trip.

[Reply](#)



Scott September 29, 2018 At 15:14

On some mags the thickness of the UpLULA's tang makes it impossible to get the last round in. On these mags I use a different loader that presses down at the back of the round.

[Reply](#)



kahlii September 29, 2018 At 15:37

Up to this point my fingers and the very simple Beretta branded mag loader that came with my Px4 has done well enough. When I bought a like new 96A1 I found I discovered that I needed the Beretta loader to top off the last couple rounds on the associated magazines. I thought about getting one of these UpLULAs but at this point the simple one works ok.

[Reply](#)



Dan Zimmerman September 29, 2018 At 15:39

I've used the Beretta loader. You're right. It works. Not as well or as elegantly as the UpLULA, but it works.

[Reply](#)



Michael B September 29, 2018 At 15:49

Have that loader. Tremendous time saver and finger saver, and high quality. Well worth the money.

[Reply](#)



How_Terrible September 29, 2018 At 16:22

The upLULA loader was the very first accessory I purchased after buying my very first pistol. Loading brand new M&P mags for the first time convinced me that there had to be a better way, and the upLULA was that way.

[Reply](#)



Green Mtn. Boy September 29, 2018 At 16:26

Maglula's just plain Work, Period.

[Reply](#)



Shwiggie September 29, 2018 At 16:55

An elegant product that does exactly what it is made to do remarkably well. I was overjoyed when they started making one for Scorpion mags... not that they're hard to load, but they can be hard to top off and empty themselves oh, so quickly.

Reply



Fat Matt September 29, 2018 At 17:13

I stippled my uplula.

Reply



Kendahl September 29, 2018 At 17:29

I can hardly load my 9 mm M&P's 17 round magazines without an Uplula. For some reason, it's easier to load my .45 ACP 1911's 7 round mags the old fashioned way.

Reply



Big Al September 29, 2018 At 19:01

Maglula is the VERY BEST!!! I load mags from 7-rd 9mm S&W Shield to Springfield XD 13rd 45acp. ALL with a hot pink uplula. It is great, especially about round 9+ on the 45's. Gotta' love it!

Reply



Keyword Spam September 29, 2018 At 19:07

I have one too. Never go to the range without it.

Reply



gordon baglaj September 29, 2018 At 19:16

*After inserting 7 or 8 cartridges or if finding some resistance, hit with the bottom of the magazine on the palm of the hand.

*Keep the magazine completely loaded for, at least, 48 hours for a complete accommodation of its internal components.

The above is a direct Copy & Paste from page 23 of the owners manual of my latest pistol purchase.

I now use this tip loading ALL my mags, even when using my miracle tool, the UpLula!

Reply



Marty September 29, 2018 At 19:46

My S&W M&P Shield 9mm came with a Caldwell loader. At first I thought what would I ever need this for? Then, I tried loading the mags by hand (or thumb). The first couple of rounds were not bad. After that I realized the Caldwell was a definite necessity. I've never needed a loader for any of my pistol mags, but believe me, one is definitely needed for the Shield.

Reply



neiowa September 29, 2018 At 19:57

Same here. After decades loading mags "the old fashion way" I

didn't see what pansy would want/need such a toy. But it IS a better way and the Caldwell works great. Have used on 9mm and 45.

Now thinking might be a point in looking at AR loader for when don't have on strippers.

Reply



Marty September 29, 2018 At 20:23

Agree. A friend of mine made loaders for the AR-15 out of oak on a CNC machine. They were beautiful and I knew I would buy one when he caught up with the orders. Unfortunately for him, he was killed in a one vehicle truck/cow collision, and I never got one. I suppose I will have to purchase a commercial model. It would have been a great remembrance of him had I bought one from him.

Reply



Bob September 29, 2018 At 20:48

The Lula's are great. Buy one for every caliber you use. Your fingers will appreciate it.

Reply



Bob in Calif September 29, 2018 At 22:37

After surgeries on both of my thumbs, I can't go more than 2 loadings. And that doesn't make for a good range day. Forgot my Uplula once, now I have two.

Reply



Greg September 30, 2018 At 08:01

Guess no one thumb wrestles anymore? 🤔

Reply



Cthulhu 2020 September 30, 2018 At 08:42

Was at the range yesterday loading with my UpLULA at one if the range tables. I was joined by a gentleman and his son (maybe 14 years old). The son was loading his Beretta mags by hand and having just a little difficulty. I topped off my mags and offered my UpLULA to him. Showed him how it works, he loaded his mags in a very short time, turned to his Dad and emphatically said "I'm getting one of these!"

As an aside, I ordered mine from Lucky Gunner a while back. The loaders (pistol and rifle) are on their specials list from time to time. Got mine for \$29.95. Hell of an effective tool.

Reply



Sora October 1, 2018 At 05:19

9mm Shield Mags are NOT Single Stack, They are Single Staggered. You will need Shield specific loaders or buy a double stack and shim. Super Thumb has Shield specific loaders. They help me a lot with new Shield mags.

[https://www.amazon.com/Super-Thumb-Magazine-Spec-](https://www.amazon.com/Super-Thumb-Magazine-Spec/)

[Loader/dp/B005BSO732](#)

Reply



TommyJay October 1, 2018 At 18:33

My Springfield XD came with a cheap one piece plastic loader that worked fine. The CZ-75B mags can be loaded with the Springfield tool, but you gotta give it a little forward twist to take up the slop and make it work well. So yeah, I bought a Uplula and never looked back.

Reply



Ed October 1, 2018 At 23:58

Watch out if you buy on Amazon. The one I got there that was fulfilled by Amazon was a counterfeit that the CEO of Maglula bought from me for evidence to prosecute. Maglula has warnings on their site to not buy from Amazon or Ebay as they are not authorized sellers and a big majority of the ones sold there are fake.

Reply



Chris October 8, 2018 At 00:48

I'm one of those that don't see the point. Been loading by hand since I was a child and I can load my mags as fast as anyone I know that uses these. If you think it helps you, fine, but I'm not wasting my money on something that doesn't benefit me, and I generally don't recommend anyone else does either (unless they really need one due to medical complications like arthritic hands/ fingers).

Reply



Chad H. December 11, 2018 At 22:12

They're great for loading large sub gun mags.

Reply



William Boehm November 1, 2020 At 08:30

I have arthritic hands and need to get a loader/loaders. I have a Taurus 9mm 709 slim, a Taurus 9mm PT 92, and a S&W-M&P 9 2.0 shield compact and a 7.62x39 (30 round magazine) AK47. I am interested in Caldwell Universal, Magulula, and Sylvan Raptor. Is there one of these that would work for all the above or would I have to get two, or three? I need something that will accommodate all the different weapons plus be easy to use with my crippled hands. Thank you.

Reply

LEAVE A REPLY

ABC



Comment:



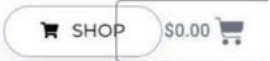

- Home
- Shop All
- AR15 Parts
- Pistol Parts
- All Firearm Parts
- Optics
- Holsters
- Clothing
- Knives
- Nylon Gear
- Affiliate Links
- Gear Reviews

The Best Pistol Speed Loader on the Market – Maglula UpLULA® Universal Pistol Loader & Unloader Review

@ Jeremy 📅 February 7, 2020 💬 No Comments



The Best Pistol Speed Loader On The Market – Maglula UpLULA® Hands on Review (Video)

► [Transparency Statement](#)

What's the worst part of shooting besides picking up brass? Loading magazines...especially when it's freezing cold outside, and you're trying to fight a 9mm round into an *almost* full mag, just to have your thumb slip and then get cut by the magazine feed lips. Ask me how I know...

When you shoot a lot, it inherently means you load magazines a lot – that is a very tedious and time-consuming process, which is annoyingly paramount in the whole shooting experience. Depending on how good at hand-jamming mags you are, you're likely going to spend about half to three-quarters of your time on the range loading magazines rather than actually shooting.

So your options to help bring that wasted time down include hiring a dedicated magazine loader, who is likely to demand \$15 per hour...OR pick up some kind of speed loader.

There are several speed loader options available, ranging from completely useless to absolutely amazing.



[Maglula](#), which stands for magazine loading and unloading accessories, is an Israeli company that has designed and manufactured the best speed loaders I've ever had the pleasure of using. They fall under the "amazing" category I just mentioned.



The Maglula UpLULA® is universal from 9mm to .45. It's small, light, compact, simple, and most importantly, VERY effective at it's intended task of loading pistol magazines. It is a speed loader that allows super fast and efficient loading of loose rounds one at a time. It works by compressing the magazine spring and follower, which allows you to literally drop a round in the mag, whereas you normally have to fight the spring pressure and magazine feed lips with your thumbs.

There are two springs built into the UpLULA® that allow you to simply let go of it after you drop a round the magazine. The UpLULA® will take care of the rest, immediately popping up into position for you to compress it again and drop another round into the magazine. The slowest part of the whole process is grabbing the loose rounds to feed this beast!



The Maglula UpLULA® solves two significant problems inherent in loading magazines: time and physical pain. The UpLULA® is super easy to use and very fast, which means you spend significantly less time loading magazines and more time actually shooting. The physical pain aspect comes from trying to compress the magazine spring and follower, while simultaneously trying to slide a round under the metal feed lips. Inevitably, you are going to slip at some point, and your thumb is going to slam into those rather sharp feed lips, which is never a good time. The level of pain and discomfort goes up exponentially if it's really cold outside and your hands are half numb and frozen. Again, ask me how I know.





If you spend a lot of time hand-loading magazines, you'll eventually get relatively good at it, but you will never beat the speed, comfort, and efficiency of a Maglula UpLULA® speed loader. Not only is this one of the best pistol magazine loaders on the market, but it is also one of the best unloaders, as well.

There is a channel along the back of the UpLULA® and a small raised portion of plastic that pushes against the back of the first round in the mag. The small lip allows you to easily push the round forward and out from under the feed lips, exactly how the magazine is designed to function. Once you get the motion down, you can empty out a fully loaded seventeen-round magazine in about three seconds or so.



Yes, you can absolutely do the same type of pushing action with your thumb, but you will be sliding it over the metal feed lips repeatedly. That's fine in short bursts, but when you unload multiple magazines by hand, your thumb does not feel so great.



I personally use a Maglula UpLULA® 9mm-45 pistol mag loader and a Maglula StripLULA® for my AR mags, loading 10 rounds at a time off standard-issue stripper clips. Maglula also makes AR loaders for loose rounds, but I have not personally tested them yet to be able to speak on their performance. From the videos I've seen, and based on how well my other Maglula products work, I feel pretty good about recommending any Maglula loader.



UpLULA™ – *9mm to 45ACP universal pistol mag loader*

Over 16,000 ★★★★★ users' reviews online !

Photo credit: Maglula.com

Between the two Maglula speed loaders I have, I've saved literally dozens of hours of time loading magazines, as well as the pain and frustration that can come from loading them. Maglula's slogan of "No more thumb pain!" is 100% accurate.



PREVIOUS POST

[How To Modify Howard Leight Impact Sport Ear Muffs On a Budget](#)

NEXT POST



[Bastion Gear Bolt Action Stainless Steel & Carbon Fiber EDC Pens](#)



Jeremy

Jeremy is the founder of The Warrior Solution and a former member of the All Guard International Competitive Shooting Team. He is also a double Distinguished Pistol and Rifle holder, Governor's Twenty tab holder, and Chief's Fifty recipient, as well as a recipient of several other shooting-related awards. Jeremy has also done government contract jobs, including work as a tactical driving instructor and shooting instructor with various contracting companies, in addition to running The Warrior Solution.

Leave a Comment

Your email address will not be published. Required fields are marked *

Type here..

Name*

Email*

Website

Yes, add me to your mailing list

POST COMMENT »



\$0.00 

Pages

- Shop Brands
- About Us
- Shipment Tracking
- Contact Us
- Affiliate Links
- Shop
- Cart
- Checkout
- Shipping Restrictions
- What Is ITAR
- FAQs
- Project AK-47
- My account
- Refund and Returns Policy
- Terms of Service

Subscribe to our email list and get 10% off your first order!

First name *

Last name

Email Address *

I'm not a robot



SUBSCRIBE!





REVIEW: HOW TO USE THE UPLULA

By GUNSPOT
Posted in #GEAR



REVIEW: HOW TO USE THE UPLULA



June 14th, 2021

5:16 runtime



SAVE



LIKE



DISCUSS



SHARE



By *GunSpot*

Loading magazines by hand is one of the most tedious chores when all you want to do is shoot. To spend less time loading and more time shooting, invest in a speed loader. My personal favorite is the UplULA speedloader by Maglula.

This speedloader is my personal favorite for a number of reasons.

SAVE



LIKE



DISCUSS



SHARE



Without a doubt, the author feels the UpLULA is one of the best tools to have in your range bag. It made loading magazines a breeze.

Size Matters

The first thing I like about it is the size. This thing is tiny compared to some of the others out there. It is super easy to travel with, if you are running to the range it will fit in your range bag with no problem, and it will easily fit into your ammo box. The bottom line here is that the size of this thing is very user-friendly. It also can fit in your pocket pretty easily, too.

SAVE



LIKE



DISCUSS



SHARE



The Maglula UpLULA is a compact tool that can be carried in a cargo pocket or attached to your keys. You should have one with you on every range trip.

It Won't Break

The second thing that I love about this speedloader is its durability. This thing feels so solid that I think you could throw it off a cliff and it wouldn't break. It's a very straightforward design, without a lot of springs, buttons and knobs to break. It's almost all one solid piece. The durability and size of this makes it a perfect speedloader to take with you out on the range.

SAVE



LIKE



DISCUSS



SHARE



If your intent is to efficiently load magazines, the UpLULA can help you get it done - even with large capacity magazines.

SAVE



LIKE



DISCUSS



SHARE



The Do-It-All Pistol Loader

The third thing I like most about this speedloader is that it's universal. You can load single-stack as well as double-stack mags. This mag can also be used to unload mags, too, if that's something you need help with.





© Copyright by Simple, the UpLULA is a rugged tool that can prevent many sore thumbs.

SAVE



LIKE



DISCUSS



SHARE



How It Works

The mag carrier works by you simply squeezing it and pushing down on the mag to depress the magazine's follower and load a round. There isn't much technical or complicated to it, and that's why I like it.

SAVE



LIKE



DISCUSS



SHARE



In testing, the author confirmed his suspicions: the UpLULA significantly reduced magazine loading time.

Just to see how much faster it was to use this mag loader versus loading a magazine by hand, I decided to do a side-by-side comparison of loading my XD-M Elite magazine. When doing the test, I tried to complete both trials with the same sense of urgency. After completing the experiment, I did notice the UpLULA allowed me to load the magazine about 20 seconds faster. If I were loading three magazines at that same pace, it would have saved a full minute.

The thing I noticed for sure was how much it saved my fingers. When using this mag loader, it's guaranteed that after a day of shooting and reloading magazines you will not have sore thumbs from pushing rounds in.



Live The Armory Life. The latest content straight to your inbox plus an automatic entry to each of our **monthly gun giveaways!**

I have read and agree to the [terms & conditions.](#)

SIGN UP

SAVE



LIKE



DISCUSS



SHARE



Call To Action

I'd advise when you buy one to get it in a bright color so that it's hard to lose or misplace. Now, is this speedloader as fast as some others out there? No, it's probably not. But it's cheap, small and durable, and it's easy to use anywhere. So this one is my favorite.

Editor's Note: Please be sure to check out [The Armory Life Forum](#), where you can comment about our daily articles, as well as just talk guns and gear. Click the "Go To Forum Thread" link below to jump in!

JOIN THE DISCUSSION



GO TO FORUM THREAD

FEATURED IN THIS VIDEO





MAGLULA UPLULA



XD-M® ELITE SERIES



THE DEBRIEF

Live The Armory Life. The latest content straight to your inbox plus an automatic entry to each of our **monthly gun giveaways!**

First Name Last Name

Email Address

I have read and agree to the terms & conditions.

SIGN UP

DID YOU ENJOY THIS VIDEO?



RELATED ARTICLES





Springfield Armory® recommends you seek qualified and competent training from a certified instructor prior to handling any firearm and be sure to read your owner's manual. These articles and videos are considered to be suggestions and not recommendations from Springfield Armory. The views and opinions expressed on this website are those of the authors and do not necessarily reflect the views and opinions of Springfield Armory.

Product prices mentioned in articles and videos are current as of the date of publication.



GUNSPOT

GunSpot was created to be the one spot for everything gun-related. With us, you can buy or sell guns. We have everything from small-caliber pistols to belt-fed machine guns. And on the GunSpot Academy, you can find high-quality original content. In our content, you will see two faces regularly. Dylan Casey is a gun enthusiast with a digital media degree who is GunSpot's Creative Director. Then there is Chief Instructor Grant LaVelle, who has decades of experience training Marines, police officers and citizens alike. Grant served with and taught marksmanship for the United States Marine Corps. After his time with the Marines, Grant served as a SWAT sniper.

[YouTube](#) [Website](#)

Join F&S+ to read exclusive stories by your favorite writers. [Just \\$1 per month >](#)



HUNTING ▾ FISHING ▾ GEAR ▾ GUNS ▾ SURVIVAL ▾ CONSERVATION ▾ NEWSLETTER SIGN-UP

FIELD & STREAM+

Gear → Shooting Gear

UPDATED APR 6, 2023 7:03 AM EDT

Best Gifts for Female Gun Owners

Give her something she can use at the range or out in the field



Walker's Razor Series Slim Shooter Electronic Ear Muffs

SEE IT



Pelican Vault Case

SEE IT



Maglula UpLULA Universal Pistol Magazine Loader

SEE IT

We may earn revenue from the products available on this page and participate in affiliate programs.

[Learn more >](#)

Written By **Amanda Oliver**

Updated Apr 6, 2023 7:03 AM

When it comes to buying gifts for female gun owners—or women who shoot—I'm a firm believer that for a lot of things, there's no difference between what you would get a woman vs. what you would get a man. However, even I have to admit that there are some things my husband owns that I don't love (looking at you, way-too-bulky range bag).

If you're shopping for a gal who shoots or hunts, there are a bunch of great present ideas out there. Below—based on my personal experience as a woman who hunts and shoots—are the best gifts for female gun owners to snag this year, from slim-fit electronic ear muffs to a stylish Beretta shooting vest.

Best Gun Case: Pelican Vault Case

BEST FOR TRAVEL





SEE IT

Think of Pelican like the Yeti of gun cases. They're known for being extremely durable and rugged—tough enough to protect her guns on the go, no matter where she's headed. From the best-selling Vault line, you can choose between a single or double rifle case, each of which feature secure push-button latches, four dense layers of foam, and wheels for easy transporting. Plus, the case itself is made of weather-resistant, crushproof material.

Best Range Bag: Exos Range Bag

BEST FOR THE RANGE



SEE IT

If her home away from home is the shooting range, she'll need something to tote all her gear around. Enter the Exos Range Bag, which has nearly 4,000 rave reviews on Amazon. Available in 10 colors and prints—including leopard print and camo—it's made of 600-denier weather-resistant nylon and has a plethora of pockets for organization and storage. It can hold up to five magazines in the spacious main compartment.

Best Hearing Protection: Walker's Razor Series Slim Shooter Electronic Ear Muffs

BEST HEARING PROTECTION





SEE IT

Prevent your giftee from damaging their ears the next time they pull the trigger with a pair of Walker's Razor Series Slim Electronic Ear Muffs. The slim-fit muffs will hug their ear, blocking out loud blasts yet still allowing them to hear outside noises via the sound amplification technology. They come in 20 prints and colors and, according to more than 50,000 Amazon reviewers, are comfortable and easy to use.

Best Shooting Glasses: Ducks Unlimited Shooting Glasses

BEST SHOOTING GLASSES



SEE IT

Ducks Unlimited partnered with popular safety eyewear brand Pyramex to create these tough-tested shooting glasses. The kit comes with 5 interchangeable polycarbonate lenses in clear, amber, sunblock bronze, orange, and vermilion. It also includes a neoprene carrying case, cleaning cloth, and breakaway cord.

Best for Pistol Owners: Maglula UpLULA Universal Pistol Magazine Loader

BEST FOR PISTOL OWNERS





SEE IT

I've learned the hard way that loading pistol mags is not fun, at least not for my small hands. Compatible with both single- and double-stack magazines, this universal loader is easy to use and will help your giftee load up faster with less stress on their hands. It's available in a rainbow of colors and has nearly 1,000 5-star reviews from Cabela's shoppers.

Best for Target Practice: Splatterburst Targets

BEST FOR TARGET PRACTICE



SEE IT

Whether she's shooting at the range or partaking in a few rounds in the backyard, help her with a pack of the ever popular Splatterburst Targets, which have more than 22,000 glowing reviews (pun intended). I use these targets and love that the fluorescent yellow makes it easy to see where your shot landed no matter the visibility conditions or distance. They come in packs of 10, 25, or 50.

Best Women's Shooting Apparel: Beretta Women's Silver Pigeon Evo Shooting Vest

BEST WOMEN'S SHOOTING APPAREL





SEE IT

I'm a strong believer that when you feel good, you shoot good. Hence, where a stylish shooting vest can come in handy for the female gun owner in your life. This one from Beretta boasts the brand's trademark high quality and durability. Available in three color combinations and in women's sizes XS to 3XL, the figure-hugging vest is made of breathable mesh and, according to one reviewer, "has all the right pockets in all the right places."

Best for the Rifle Shooter: Girls With Guns BakTrak Vapor Rifle Sling

BEST FOR THE RIFLE SHOOTER



SEE IT

All you have to do is look at the brand—Girls with Guns—to know that this is a good choice for any female shooter who owns a rifle (their slogan is "Designed by women for women"). The silicone rubber backing provides extra grip so it isn't sliding off her shoulder, and the strap itself is rated for up to 500 pounds. It also features easy-to-adjust buckles and a muted camo print.

Best Shooting Aid: Primos Trigger Stick Gen 3

BEST SHOOTING AID



SEE IT

Help her shoot more accurately—and prevent her arms from getting sore and fatigued—with this Primos shooting stick. It helps eliminate human error from unnecessary wobbles or movement that come from tired muscles or an overexcited hunter. This one has received positive reviews from thousands of Amazon customers for its stability, light weight, and durability. Plus, it can extend tall enough to be used from a standing position.

Best for Ammo: Magpul Daka Bags

BEST FOR AMMO



SEE IT

My husband might be okay lugging a clunky ammo box to the range—but I am not about that life. Instead, I'd rather fill these lightweight Magpul bags with the ammo I'll be needing for the day and toss them into my range bag. Made of water-resistant polymer with super secure zippers, they come in a variety of sizes and are tough enough to withstand quite a beating.

Best Jewelry: Story 12 Gauge Faux Bullet Earrings

BEST JEWELRY



SEE IT

Struggling to find something for the gun gal who has everything? Consider these faux bullet earrings,

which are silver gold plated and look just like a 12 gauge shotgun shell. You know how the saying goes: You can take the girl out of the range but you can't take the range out of the girl. She can wear these anytime, anywhere.

Best for the Wife: Groove Life Stackable Rings

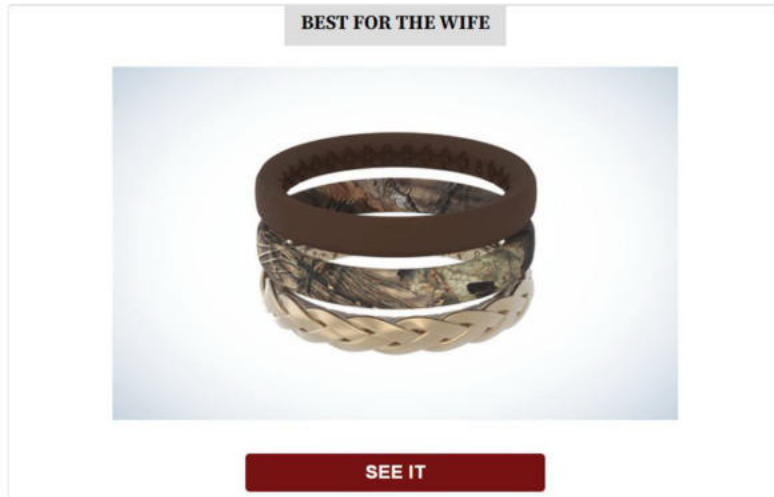

I wore my rings shooting once, and that's all it took for me to realize I hated it. My engagement ring kept knocking around and the wedding band dug into my finger. These stackable rings from Groove Life saved me (and my skin). Not only do they come in a plethora of camouflage patterns perfect for heading out into the field, but they're also extremely comfortable and are made of medical-grade silicone with ridges along the inside that allow for breathability and flexibility.

Best Tactical Pants: Under Armour Women's Tactical Patrol Pants II

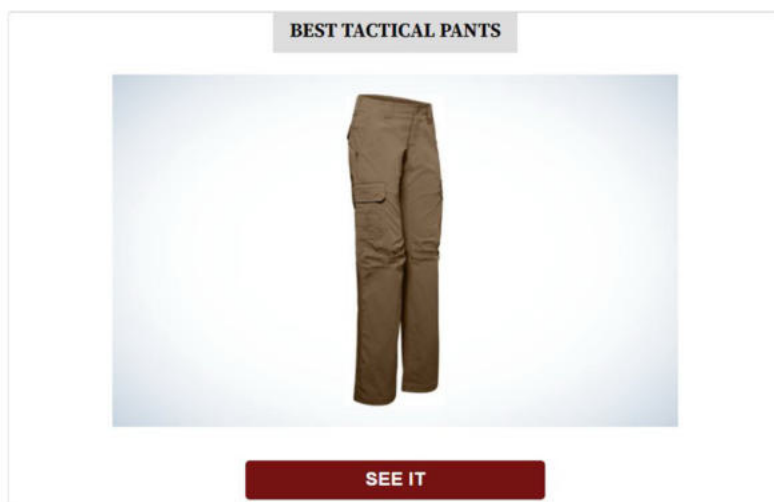

The problem with a lot of women's hunting and shooting gear is that the apparel is just shrunken-down men's clothing—which isn't exactly comfortable or flattering 99% of the time. These tactical pants from Under Armour, however, are a real win. Available in six earth tones and two camo patterns, the pants come in women's sizes 0 to 20 and are made with tough sweat-wicking ripstop material. They have plenty

of spacious cargo pockets for your giftee to stash all her things.

Best for the Pistol Owner: [Sig Sauer Red Dot Sight](#)



SEE IT

If she struggles to use the iron sights on her pistol or just wants to upgrade her gun, she'll love this [red dot sight](#) from Sig Sauer. It's simple to sight in and has eight different brightness levels. Boasting a 10-year battery life, the sight automatically turns on when it senses motion—a great convenience for any shooter.

HANDGUNS

SHOOTING GEAR

COMMERCE

REVIEWS

MORE TO READ

RELATED

Best Trail Running Shoes of 2023, Tested and Reviewed

Whether you're jogging a paved path or tackling...

READ NOW

RELATED

Best Muck Boots of 2023, Tested and Reviewed

Muddy and wet conditions call for specialized footwear—which...

RELATED

This Emergency Blanket Folds Up Smaller Than a Soda Can—And It's Just \$18 Right Now

Add this portable Mylar blanket and sleeping bag...

Want more of the Great Outdoors?

Sign up for the Field & Stream newsletter and get the latest intelligence straight to your inbox.

LET'S GO

FIELD & STREAM

LINKS

[Home](#) [About Us](#) [How We Test & Review Products](#) [Editorial Standards](#) [Contact Us](#) [Newsletter Sign Up](#) [Sitemap](#) [Privacy Policy](#)
[Terms & Conditions](#) [Affiliate Disclosure](#)

[Do Not Sell Or Share My Personal Information](#)

FOLLOW US



DISCLAIMER(S)

Articles may contain affiliate links which enable us to share in the revenue of any purchases made.

Registration on or use of this site constitutes acceptance of our [Terms of Service](#).

© 2023 Recurrent. All rights reserved.



Above: Left - To load the magazine, the UpLULA is slid over the magazine body and pulled down. The beak pushes downward on the magazine follower. Center - The next step is the round is slid on top of the beak into the magazine. Right - Now the lever is released and the beak slides out from underneath the cartridge fully seating it inside the magazine. To insert additional cartridges the same process is repeated with the only difference being the beak pushes down on the top cartridge instead of the magazine follower.

ing the one on the top. This is continued until the magazine is empty. No cartridges are damaged nor is there any damage to the magazine. Normally, to manually unload a magazine one would either push the top round forward until it cleared the feed lips or take a bullet tip and push downward on the inside cartridge releasing the top cartridge from the magazine. Both are time consuming and can damage the cartridges. Due to most modern military weapons having double column magazines, Maglula went on to adapt this design to other common battle rifles.

The AK47 & Galil LULA works the same except it attaches at two points: the protrusion on the front and the catch on the rear of the magazine. This LULA will work on any 7.62x39mm AK magazine regardless if steel, Bakelite or polymer and

on any 5.56x45mm Galil magazine. Maglula went on to also design a LULA for the 7.62x51mm FN FAL magazines and one for the 7.62x51mm M14/M1A magazines.

The front of the M14/M1A LULA attaches to the engagement notch of the magazine and the rear is a wire rod that secures under the magazine rear catch. A note on this LULA, this will work with most 1st generation ArmaLite AR-10 magazines. Due to the assault weapon ban, ArmaLite modified GI M14 magazines to adapt to their AR-10. So the forward notch and mag catch were left on the magazine though they serve no purpose. These magazines can be loaded with the M14/M1A LULA. However, magazine samples have been found where the magazine catch had been removed or fell off and this maga-

zine can not be loaded with the LULA. The sample LULA has loaded many AR-10 magazines flawlessly. However, the newly manufactured and designed ArmaLite AR-10 magazines can not be loaded with the M14/M1A LULA. They resemble more of an M16-type magazine in their construction.

Maglula did not stop with assault rifles they designed them for submachine guns as well to include the Uzi, MP5 and the Colt 9mm SMG. The provided LULA was used to load many Colt 9mm SMG magazines. This proved to be heaven sent. The feed lips on those magazines are quite sharp and loading several magazines gets quite hard on the fingers, especially when you start reaching the magazine's capacity. The LULA made it easy and painless. Some people claim they can load maga-



Left: IDF LULA markings. They translate to "M16 Catalog # 113516089, LULA Loader/Unloader, Maglula Company Ltd." Below: Two prototype LULAs flank a final production LULA on an M16 magazine.



zines faster by hand. That may not be so if one loads a few magazines. However, pain sure intensifies when one loads many magazines and consequently this certainly slows down loading. Anyway, this is not all about speed this is also about comfort loading many magazines painlessly.

The UpLULA (Universal Pistol Magazine Loader)

Pistol magazines are harder on the fingers than rifle magazines partially due to the fact that most are double column magazines with a single feed. Most of the steel aluminum magazines have feed lips and it can make your finger sore very quickly. This is significant when it comes to the 2.3 ounce UpLULA is a universal loader that can be used with magazines for 9mm NATO, .40 S&W and .45 Auto. The sample UpLULA v



What dealer resources are you looking for?

SEARCH

** DEALERS: U.S. FIREARMS REPORT 2023 **

SHOOTING
INDUSTRY

FIRST LOOK DISCOVER DEALER ADVANTAGE INDUSTRY NEWS GUNS VIDEOS SUBSCRIBE



ACCESSORIES

AMMUNITION

CARRY OPTIONS

FIREARMS

GUN CARE

KNIVES

SIGHTS & OPTICS

FAMILIAR FAVORITES CONTINUE TO RESONATE

WRITTEN BY MELISSA PORTER

FIRST LOOK | ACCESSORIES | WOMEN'S PRODUCTS |
2020

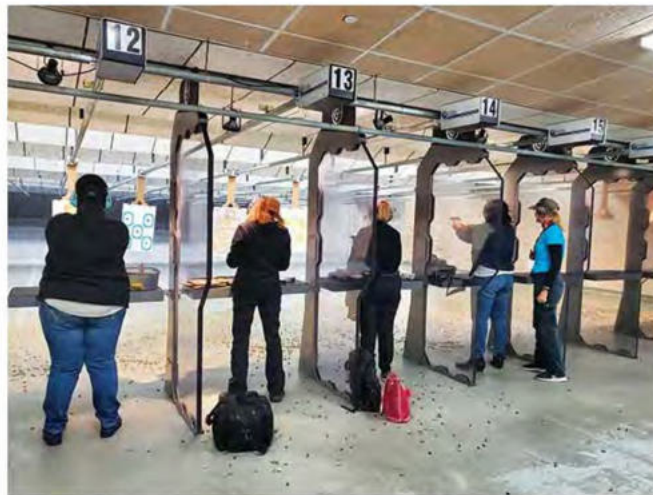

Through its Lead & Lace Ladies shooting group, Georgia Gun Club has developed a significant base of regular customers. Light-shooting .22s are an early favorite of new shooters, according to General Manager Beth Martin.

In the Feb. 2020 issue, we explored the impact of new-for-2020 products on the female segment of the industry (*Arms & The Woman*, “New Products Ready For Plinking, CCW Or Hunting”). While stocking fresh products geared toward women represents a more than capable approach to bring in this burgeoning group of customers, there’s also nothing wrong with sticking with the tried-and-true.

“It’s all the old favorites that still attract women,” said Bren Brown, co-owner of Frontier Justice with locations in Lee’s Summit, Mo. and Kansas City, Kan.

What are some of these favorites?

“UpLULA Speed Loaders, firearms with a nice grip — like the Smith & Wesson Shield — leggings able to hold firearms and conceal-carry purses that look like actual stylish ones,” she continued.

Brown has made a concerted effort to ensure women feel welcome at both of her establishments, which feature a dedicated fashion boutique.

“Our boutique is a huge *WELCOME* sign to women coming to our store,” she shared. “It’s the same with hosting a date night, women’s-only classes and having a sales staff that takes the extra time to treat everyone with dignity and respect — whether they’re talking to a beginner or an advanced shooter.”

Frontier Justice hosts several “Date Night” packages throughout the year, with Valentine’s Day the most recent. It includes a lane rental for two, one firearm rental, two boxes of ammo, dinner, a rose, eye protection (to keep) and a photo opportunity. Members receive a significant discount.

Bren revealed an unexpected trend: “It’s the woman who buys Date Night, rather than the man — which has surprised us.”

www.frontierjustice.com

Range Visits

Boasting Georgia’s only 100-yard indoor rifle range, Buford-based Georgia Gun Club has been successful in its efforts reaching out to women. General Manager Beth Martin informs those who do come in for a visit don’t often arrive alone.

“The women we see shooting long guns on our 100-yard indoor ranges definitely have more experience shooting,” she said. “They usually come with the family, spouse or boyfriend to shoot as opposed to by themselves to work on pistol shooting.”

Matching Brown’s earlier observation, Martin earmarked the Maglula UpLULA as a perennial favorite for customers.

“The UpLULA magazine loader is a must for any range bag,” she contends. “We have them available to use on our ranges, and women grab them up after they’ve used one. Plus, we have them in many colors so they don’t get lost in a range bag.”

Touted in the aforementioned February article, the GLOCK 44 has been an early contender for women at the Georgia Gun Club.

“The GLOCK 44 has really done well with our female market,” Martin added. “We have so many new shooters to the industry who start with Georgia Gun Club. This addition of a reliable .22-caliber pistol is a plus to get them started with learning the basics.”

www.georgiagunclub.com





HNR Co-Owner Hillary Dube and Manager Lora DeMaio showcase the Maglula UpLULA. Dube shared she keeps them on the front counter to capitalize on add-on purchases, while leaving a model out for demos. “[They’ve] flown off the shelves!” she added.

All-Women Meetup Thrives

Hillary Dube, co-owner of HNR Gunworks in Inverness, Fla., opened her store mid-2017 and has already cultivated supportive ties within her community. A new monthly endeavor is providing further opportunities for her store to propagate a positive message of the shooting sports.

“We started a Women’s TEAM (Training, Education, Action, Meetup),” she explains, “taught by our female NRA instructor Sabrina Watson. We’ve had such a great turnout of women shooters — novice to competition shooters who enjoy the sport and camaraderie!”

The meetups include safety information, conversations about Florida’s concealed carry laws, live shooting and more.

When asked what prompted her interest in facilitating an all-women’s group, Dube answered: “I think it’s so important to offer a chance for women to get together, learn and support each other, especially in these politically trying times where it can be frowned upon.”

To promote the HNR Women’s TEAM, Dube also launched a Facebook page. It’s also well positioned to provide natural tie-ins to developments at her store. TEAM events attract a wide range of women, even creating powerful mother-daughter experiences.

“We have women from age 11 to 87, and I enjoy watching them grow and enjoy the sport,” she shared. “I think these groups will continue to be an emerging trend.”

While there is a fee involved for those attending the event, Dube also referenced another way they impact her store’s bottom line: prospective customers can get acquainted with products already in stock at HNR Gunworks.

“These events allow us to introduce Flashbang holsters and UpLULAs, and other handy products that are useful at the range and for carry!” she exclaimed.

Of note here: the mention of the Maglula UpLULA was unprompted in each of our three interviews — so, something to keep in mind as you place your next order. Dube explained the rise of popular compact pistols necessitates sales of speed loaders.

“In single-stack pistols like the SIG P365, those last few rounds are nearly impossible to load — unless you have a speed loader,” she said. “UpLULAs have *flown* off the shelves for both new and veteran shooters alike. They should be in every range bag!”

www.hnrgunworks.com

What tried-and-true product lines are resonating with your segment of female customers? Share with the *SI* team, and be featured in a future issue!



[Click To Read More Shooting Industry April 2020 Issue Now!](#)

FIRST LOOK | ACCESSORIES | WOMEN'S PRODUCTS |

2020



WE THINK YOU'D BE INTERESTED IN THIS, TOO





ICYMI: INDUSTRY...



0

News from around the firearms industry, Aug. 21-25, 2023, featuring Pyramyd AIR, Partner With A Payer, Kimber and more ...

[READ FULL ARTICLE](#)



BRAVE...



0

September is National Suicide Prevention Awareness Month. Perhaps this time of year, over any other, would be the time to emphasize brave conversations with...

[READ FULL ARTICLE](#)



FOCUS ON "MAKING..."



0

Customers are most satisfied when you reduce their effort and remove obstacles to getting what they want. Smooth, efficient transactions are more likely to...

[READ FULL ARTICLE](#)

DEALER ADVANTAGE

SIGN-UP TO RECEIVE SPECIAL CONTENT, NEWS, OFFERS, AND MORE!

ENTER YOUR EMAIL ADDRESS

SUBMIT



VIDEOS
ADVERTISING
MISSING ISSUE

SUBSCRIBE
CONTACT

ABOUT
ADDRESS CHANGE



HANDGUNNER

GUNS

UPLULA MAGAZINE LOADER

EASE THE PAIN AND SHOOT MORE!

WRITTEN BY DAVID FREEMAN

GEAR | ACCESSORIES
2019

1



Uplula

The UplULA loader comes in six colors. David's choice was hi-vis yellow, with his name applied in market, to prevent "walk off" at the range.



Uplula

The compact UplULA Magazine Loader by MagLula.

Loading magazines is one of the challenges new shooters always encounter — especially people with hand-strength or pain issues. For years I taught people how to load magazines, stressing the importance of a good handhold and steady pressure in the right direction when inserting cartridges. Then came a day I could no longer do it without the aid of a magazine loader.

I've tried several magazine loaders with varying degrees of success but the one that works the best for me is the UplULA by MagLula. This handy little loader fills pistol magazines quickly and easily meaning you'll spend less time at the range loading magazines and more time shooting. Moreover, it doesn't hurt because your fingers and thumbs aren't pushing against a strong spring and they aren't getting pinched by parts of the magazine. With practice, you can load as fast as one round per second.

<https://gunsmagazine.com/gear/uplula-magazine-loader/> 09.10.2023



Uplula

Even the pro baseball player who came into David's shop tried one and bought it immediately!



Uplula

The UplULA loader is simple to use: Press down, squeeze the lever, drop the round and go shooting!

Press, Squeeze, Drop, Load

Hold the magazine upright with the bottom resting on a solid surface. Place the loader over the top of the mag, press down lightly while squeezing the lever to depress the follower, drop in a round, and push the lever quickly to push it into the mag. Repeat the process until the magazine is full. Everyone who has tried it found the loader simple and easy to operate. We even had a professional baseball player in our store one day and handed him one to try. Not only did he buy the UplULA, he told all his shooting friends about it. In fact, I can't remember ever offering it to someone who didn't buy one.

The UplULA is made of a tough military-grade polymer and it's available in six colors. I got one in high-visibility yellow and put my initials on it with marker so it wouldn't walk off. The pink ones go off the shelf quickly while many guys want macho colors like hunter green, dark orange or black.

The loader locks in the closed position when not in use so it takes up minimal space in pocket or range bag. You can use it with single- and double-stack 9mm, .357 SIG, .40 S&W, 10mm, .45 ACP magazines, and some .380 mags. Cost is around \$35 wherever shooting accessories are sold.

<https://www.maglula.com>

<https://gunsmagazine.com/gear/uplula-magazine-loader/> 09.10.2023

The Keefe Report: Maglula Takes On Amazon

by MARK A. KEEFE, IV, EDITORIAL DIRECTOR posted on January 17, 2020
NEWS

f t i Support NRA American Rifleman DONATE



When it comes to writing about magazine loaders, in particular those from [Maglula](#)—notable the [UoLULA](#)—the word “trusty” often appears in front of it. I did it a few months ago, and in [his story on the 5.7x28 mm Ruger-57](#), Managing Editor Kelly Young did the same thing. If I leave home without it, there is usually some swearing involved. Just last year, we awarded a [Golden Bullseye](#) to Maglula for its [10/22 BX LULA](#) loader as Accessory of the Year. I haven’t worn mine out yet, but it’s not for lack of trying.

When it comes to my personal use, I regard the Maglula universal loader as the better mouse trap. It’s always in my range bag whenever I have to load double-stack, single-feed magazines. This is an Israeli company—that only manufactures in Israel—with only 10 employees, but one that has had a huge impact on the shooting sports.

Maglula’s CEO is Guy Tal, and not only is he a gifted inventor, he’s also pretty scrappy. How scrappy? He’s suing Amazon. Tal was fed up with Amazon continuing to sell forgeries and knock-offs of his loaders. For three years, he took note of the counterfeits, and even ended his emails with what to look for in fake Maglulas as his signature line. Now he’s in a David-versus-Goliath legal fight.

While many companies, especially small companies, just whine about it, on Dec. 12, 2019, Maglula filed suit, which you can read below. By Jan. 3, 2020, all Maglula loaders were pulled from Amazon. “We found Amazon breaking IP law in ways never reported before. It is the most comprehensive, broad, and detailed IP-related lawsuit ever filed against Amazon,” wrote Tal.

“Many in our industry suffer from counterfeits. I just happen to be hard-headed enough and relentless chasing both after the Chinese manufacturers and the sellers, such as Amazon,” wrote Tal. “Without our multiple registered and unregistered IP as weapon, Maglula would have been shut down by now.”







Turns out a couple of friends of mine actually had counterfeits made in China. Regardless of how the suit goes, NRA members should be aware that Maglula works through U.S. distributors, and you can find a list of them [here](#)—you won’t find them on Amazon. Read the full lawsuit at [this link here](#).

In this article: MAGLULA, UoLULA, MAGAZINE LOADER, MAG LOADER, AMAZON, LEGAL, COUNTERFEIT, CHINA, MARK KEEFE, KEEFE REPORT

Related Stories

- [Preview: Maglula US-Flag UoLula Loader](#)
- [Snapshots: Definitely Not Legal For Sale In California](#)
- [Product Preview: MagPump 9mm Magazine Loader](#)
- [Keefe Report: Gratitude for Our First Freedom](#)
- [The Keefe Report: The Future of Colt](#)

Most Popular

- Review: Big Horn Armory Model 89 Black Thunder 
- 8 Tactical Lever-Action Rifles Available In 2023 
- 8 Smallest Handguns You Can Own 
- 14 New Guns For 2022 
- I Have This Old Gun: M1895 Nagant Revolver 
- New For 2023: Tactical Solutions Owyhee Magnum 



Preview: Maglula US-Flag Uplula Loader

by AMERICAN RIFLEMAN STAFF posted on April 20, 2022
NEWS, EXTRAS



Support NRA American Rifleman



In a special-edition design celebrating Maglula's 20th year on the U.S. market, the popular Uplula pistol-magazine loader is now available in a red-white-and-blue color scheme. The pocket-size universal loader works with nearly every double-stack pistol magazine available, from 9 mm Luger to .45 ACP. Special inserts are available for single-stack M1911 magazines, and it will function with select .380 ACP magazines as well. Price: \$35. *Contact: Maglula; maglula.com.*

In this article:
MAGLULA US-FLAG UPLULA LOADER, MAGLULA, UPLULA PISTOL-MAGAZINE LOADER, UPLULA, LOADING, AMMUNITION, HANDGUN, PISTOL, ACCESSORIES, TARGET SHOOTING, MAGAZINE

Related Stories

[Product Preview: Maglula UpLULA](#)

[Preview: Holosun Enclosed Pistol Sight](#)

[Preview: Kestrel Ballistics KST1000 Shot Timer](#)

[The Keefe Report: Maglula Takes On Amazon](#)

[NRA Gun of the Week: SIG Sauer M11-A1 Compact Pistol](#)

Most Popular

Review: Big Horn Armory Model 89 Black Thunder



8 Tactical Lever-Action Rifles Available In 2023



8 Smallest Handguns You Can Own



14 New Guns For 2022



I Have This Old Gun: M1895 Nagant Revolver



New For 2023: Tactical Solutions Owyhee Magnum



<https://www.americanrifleman.org/content/preview-maglula-us-flag-uplula-loader/> 09.10.2023





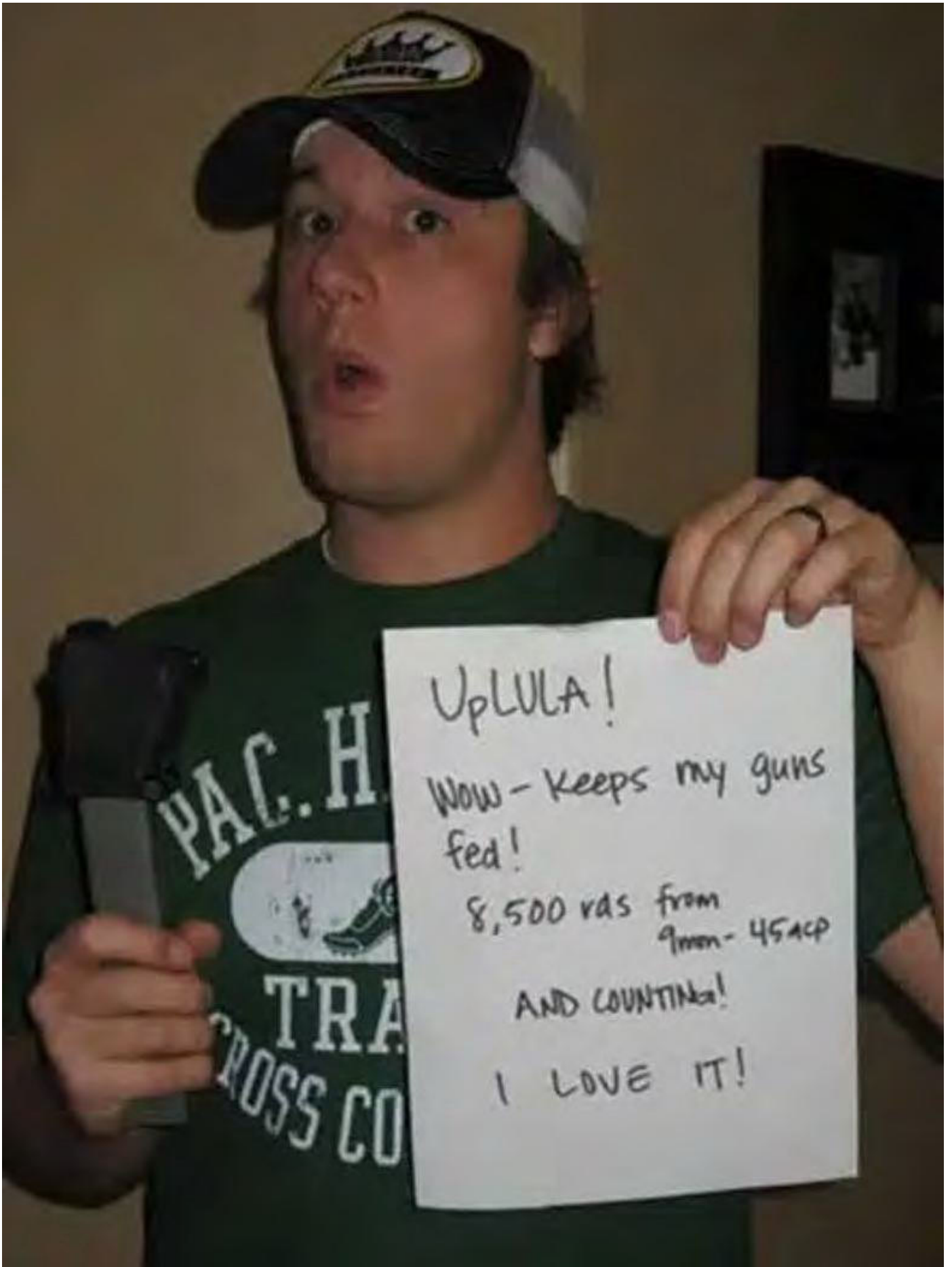

UPLULA!

Wow - keeps my guns
fed!

8,500 rds from
9mm - 45ACP

AND COUNTING!

I LOVE IT!





AK LULA

LOADED 600 rds on
the first day I got it.

~3,500 more since
then.



UPLULA

~8,000 rds of
9mm - .45

All my guns and newbie
friends love it!
I make them load up their own
mag.



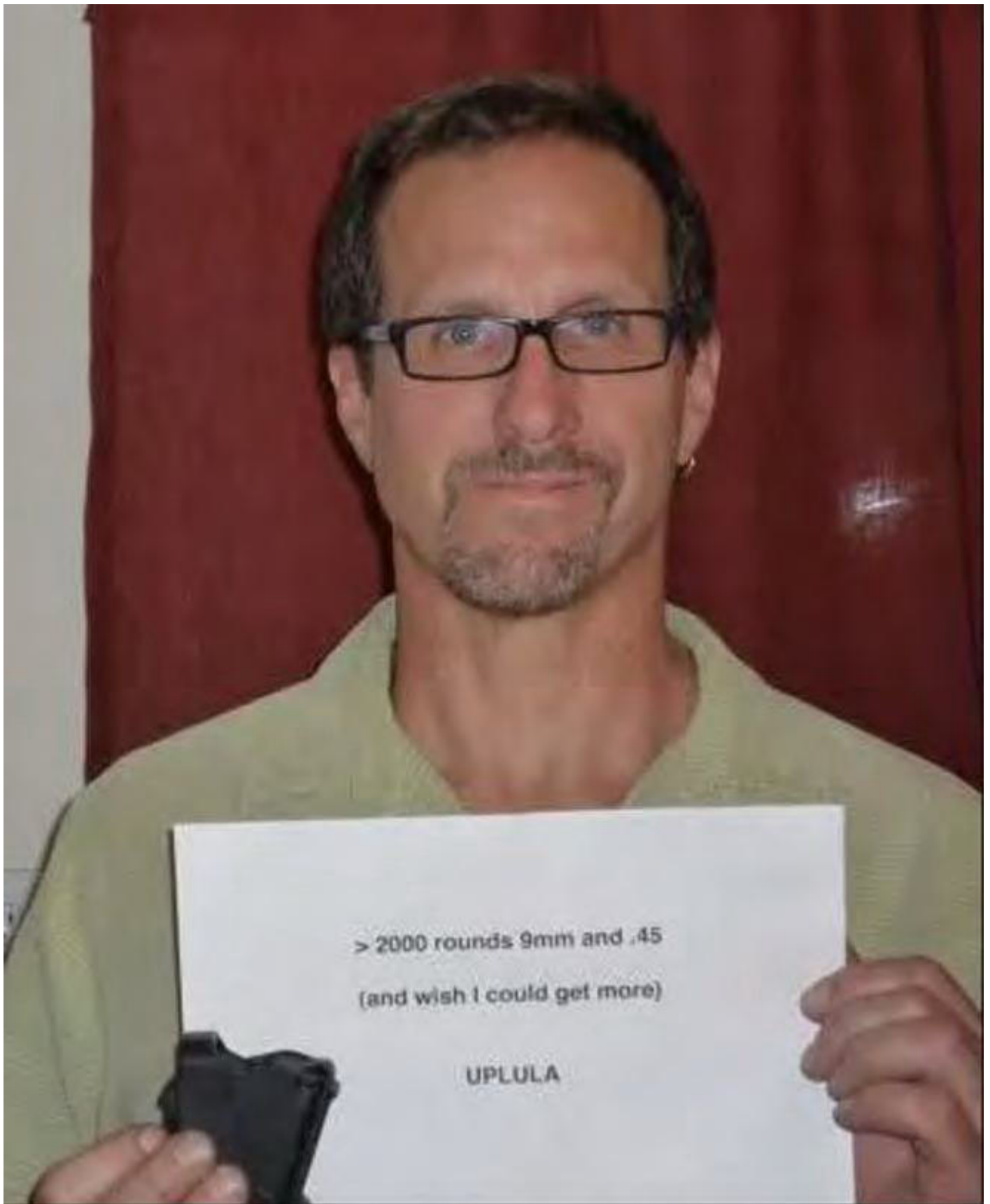



I've tried the rest ...

UpLULA
is the BEST!

7000 rounds
and going strong!





- **LULA – AR-15**

- ~10,000+ rounds of ammunition loaded

- **LULA – UZI**

- ~12,000+ rounds of ammunition loaded

- On my UZI and AR-15 9mm carbine

- **UpLULA**

- ~1,200+ rounds of ammunition loaded

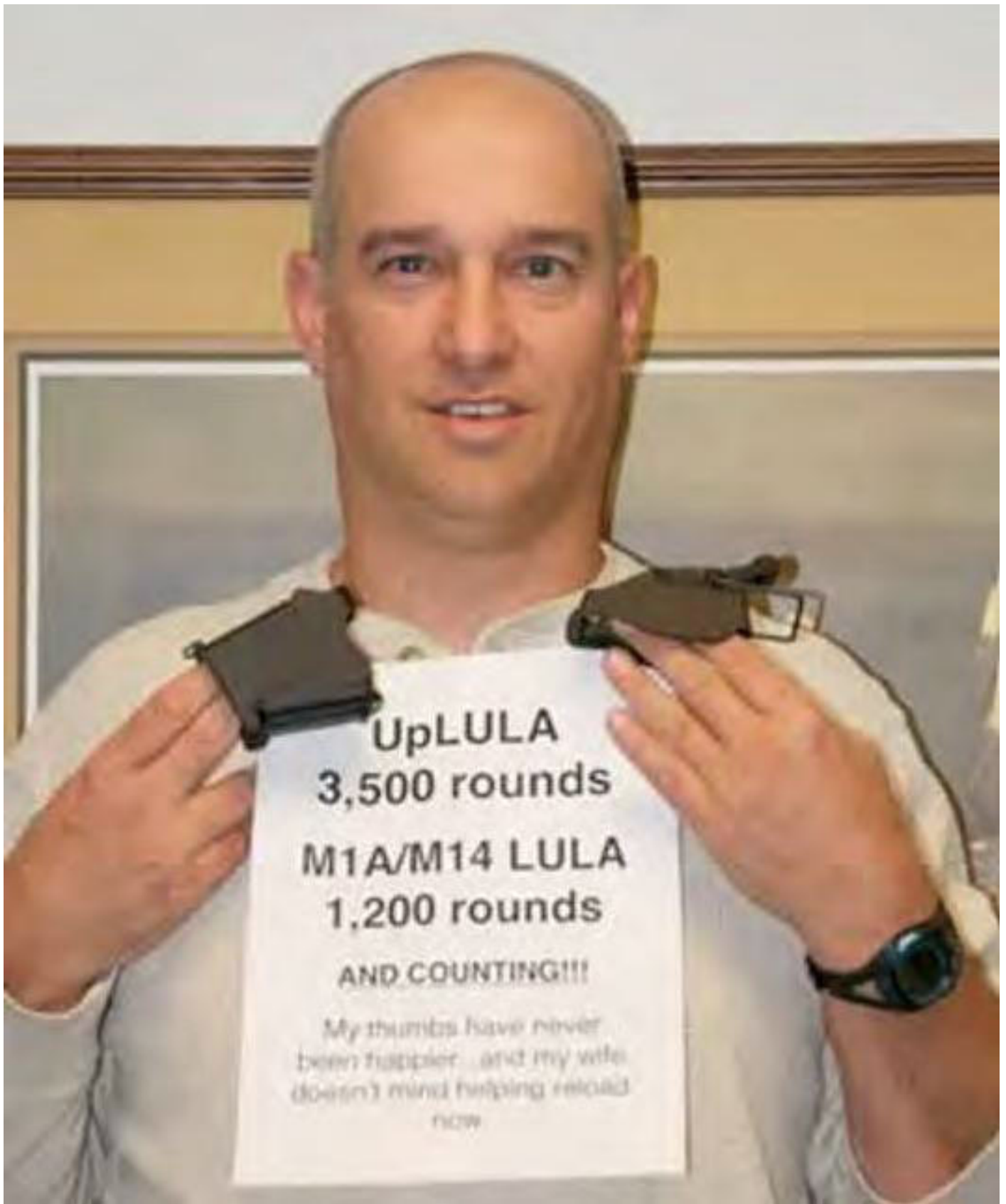





AR 1500 1500
UPLULA note in park

AR 5000 5000
AR LULA

More than 6500 Round
and counting







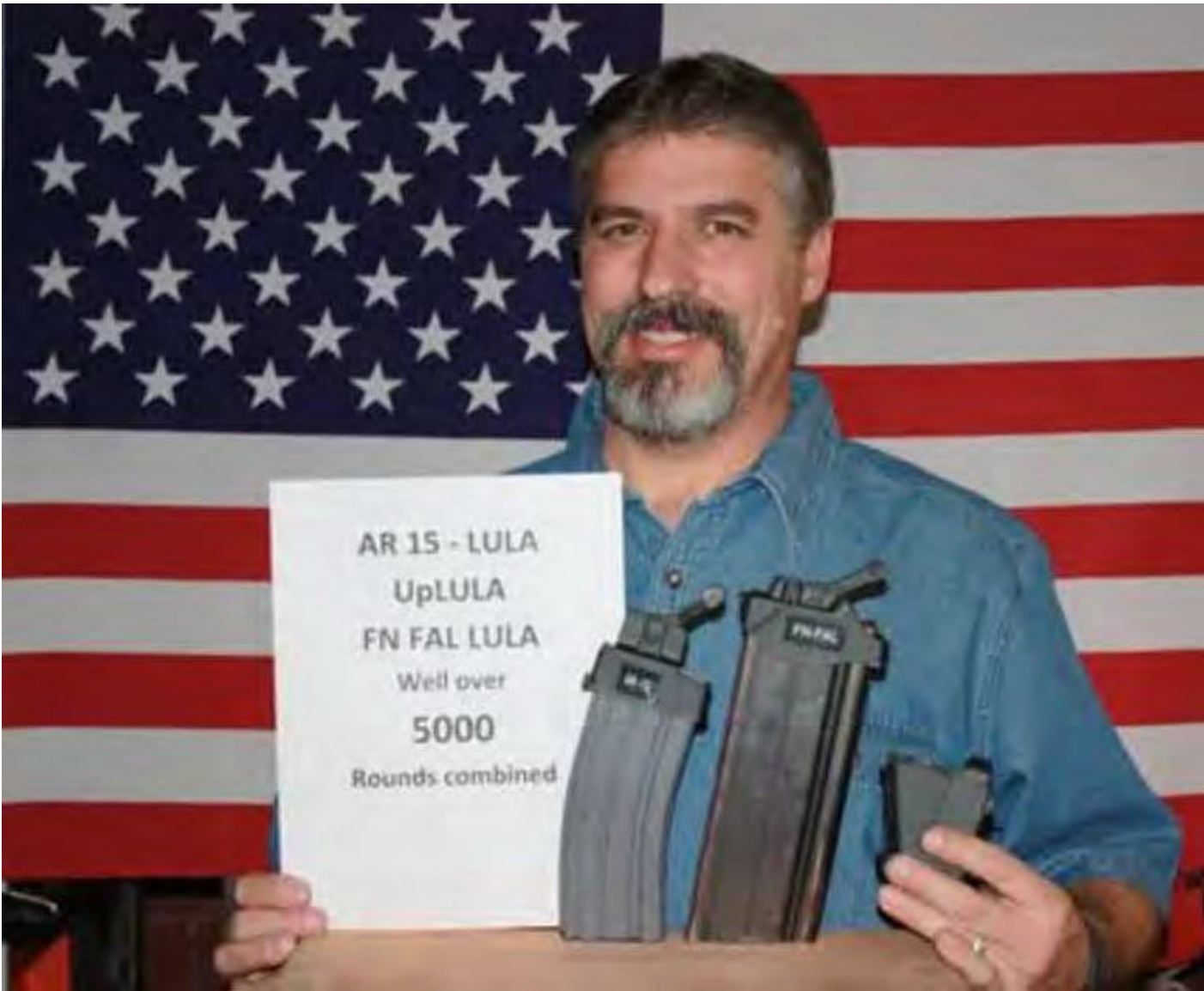





UPLULA UNIVERSAL
9mm 45 AUTO IN 09
200 3400 MINES IS
SHI NEW!
The best thing since
Apple Pie. THANKS GUYS.
S/F ROGER FLORES







































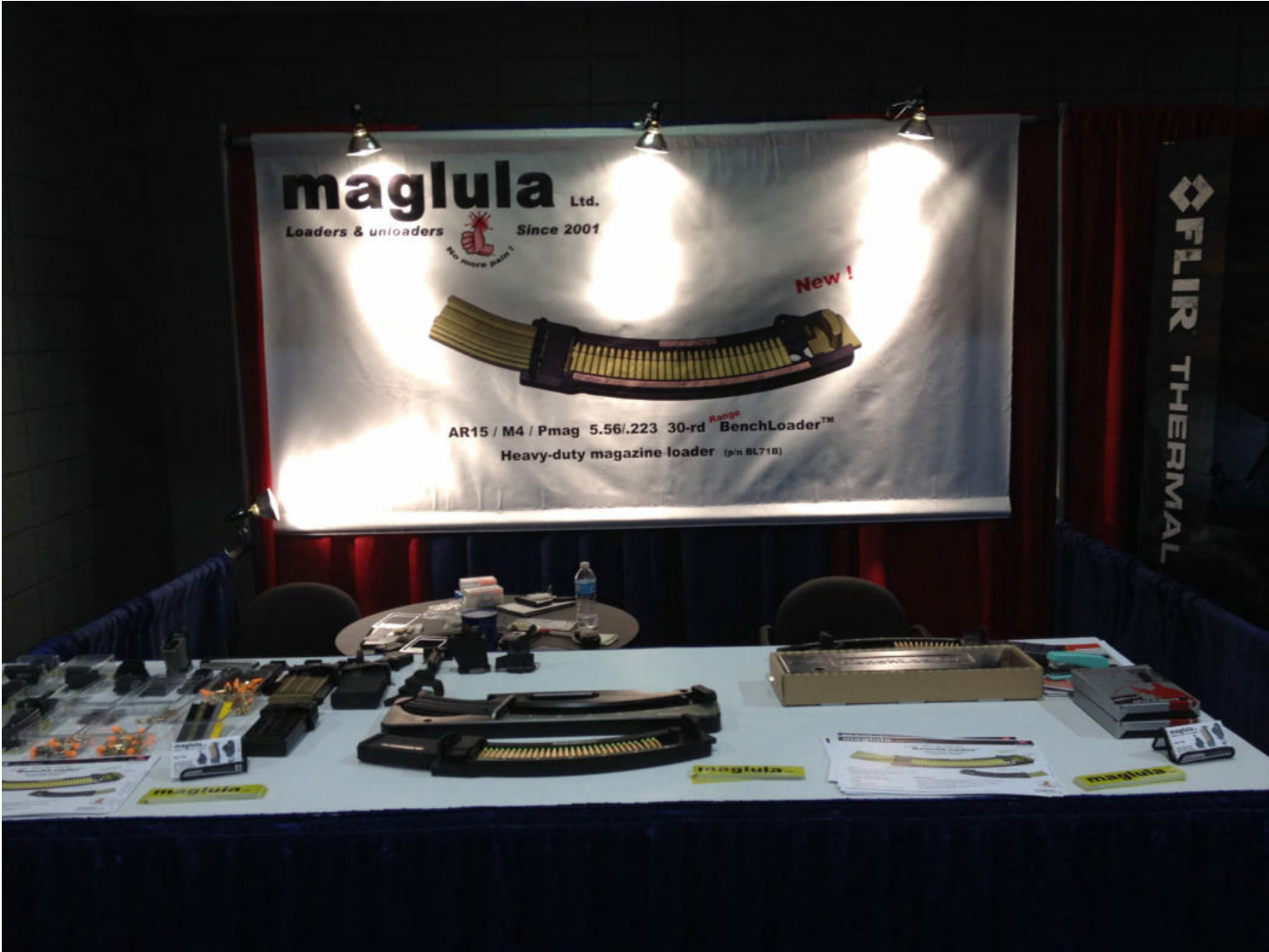





































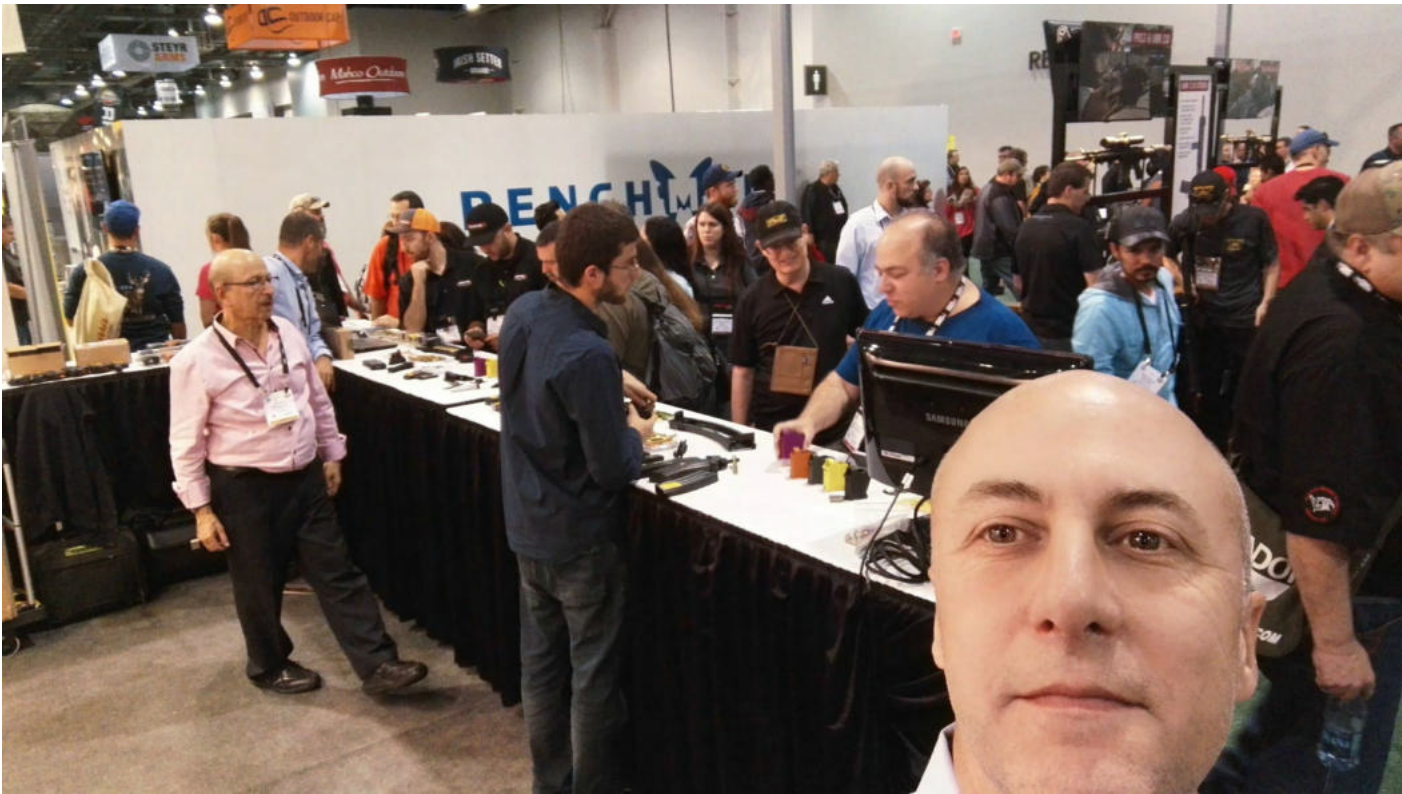

























More than 58K attending SHOT Show in Las Vegas



Attendees wander miles of aisles at the 2017 Shooting Hunting and Outdoor Trade (SHOT) Show in Las Vegas. This is the trade show where manufacturers and vendors meet to decide what customers will find on store shelves during the coming year. The show is not open to the public. (Doug Nielsen)

<https://www.reviewjournal.com/business/conventions/shot-show/more-than-58k-attending-shot-show-in-las-vegas-1577754/>

1/8

By Todd Prince Las Vegas Review-Journal



January 20, 2019 - 1:55 pm

Don't miss the big stories. Like us on Facebook.

Follow 328K

Updated January 20, 2019 - 2:10 pm



Listen to this article now

-04:59



Presented by NAQVI INJURY LAW

Gun manufacturers will be aiming for big sales this week as they storm into Las Vegas for the industry's biggest trade show.

The Shooting, Hunting & Outdoor Trade Show, better known as the SHOT Show, will draw more than 58,000 industry professionals to the Sands Expo and Convention Center from Tuesday through Friday.

The four-day trade show is the industry's business-to-business equivalent of Black Friday, as manufacturers and wholesalers pen multimillion-dollar deals with retailers and law enforcement agencies for firearms, ammunition and accessories such as holsters and scopes.

The show is also a bonanza for Las Vegas as attendees spend nearly \$90 million on hotels, food, drink and souvenirs, said Chris Dolnack, senior vice president and chief marketing officer for the National Shooting Sports Foundation, which runs the show.

Local gun ranges see business pick up during the week. German-based manufacturer Sig Sauer will host as many as 2,000 people Monday at the Rifle Pistol Center at the Clark County Shooting Complex. About 800 people are expected to visit the Boulder Rifle and Pistol Club on Monday to test the latest products from more 200 manufacturers. The Metropolitan Police Department also will host a test shooting event that day. About 1,000 law enforcement officials attended the Metro event last year.

SHOT Show attendance though will be slightly down from the 60,000 visitors last year as industry growth stagnates after years of robust expansion driven in part by concerns over stricter legislation. And the show has tightened registration requirements to ensure attendees are buyers or sellers representing industry businesses, Dolnack said.

Firearms is an \$8 billion industry in the United States.

Female attendance has grown in recent years as as more women take up shooting, Dolnack said. Women account for 11 percent of SHOT Show attendees, he said.

The Clark County Shooting Complex has seen “a lot more women” coming to the range over the past few years, said Senior Management Analyst Steve Carmichael, who will be attending the show.

15,000 guns

The SHOT Show covers nearly 700,000 square feet of space at Sands — the size of about 12 football fields — and the exhibitor aisles stretch roughly 12 miles, Dolnack said. Sturm, Ruger & Co.; Remington Arms Co.; Smith & Wesson and Sig Sauer will be among the 2,400 exhibitors.

The show will feature more than 7 million pounds of goods, including 15,000 firearms from handguns, shotguns to semiautomatic rifles. Neither firing pins nor live ammo are allowed on the floor.

Las Vegas gun shop owners will be among attendees perusing the firearms on display. But the seven local companies the Review-Journal contacted either declined to comment on the show or did not return calls.

Law enforcement

A quarter of the exhibition space at SHOT Show is dedicated to law enforcement, the fastest-growing show segment, Dolnack said.

Law enforcement officials account for about 15 percent of attendees and include members of police departments; the Federal Bureau of Investigation; Bureau of Alcohol, Tobacco, Firearms and Explosives; and Department of Homeland Security.

Officers in attendance are either responsible for armament and equipment purchases or training, Dolnack said. The show features a law enforcement education program that instructs officers about best practices and the latest technology. The program includes seminars on active-shooter situations, the use of drones and optics and virtual reality training.

“Most of the people that are attending these seminars are trainers, and they will take the knowledge that they gain here and share it in their academies,” Dolnack said.

Shooting tech

The show certainly won't be all guns and ammo. Companies have worked to harness the latest Silicon Valley technology to bring innovative products to all industries.

Meggitt Training Systems and Virtra Systems will show off their virtual reality simulator used by police around the country. The systems consist of screens that wrap as much as 300 degrees around an officer and present a life-threatening situation that must be resolved.

Other innovations at the show aim to enhance safety and accuracy during shooting range practice. The Safeshoot device immediately alerts a shooter when another device holder is in the line of fire at a range of 900 yards.

Software and app developers will show off tools to measure wind speed and calculate trajectories. The innovations come as range shooting — especially long-range shooting — grows in popularity around the United States.

The Review-Journal is owned by the family of Las Vegas Sands Corp. Chairman and CEO Sheldon Adelson. Las Vegas Sands operates the Sands Expo and Convention Center.

Contact Todd Prince at 702-383-0386 or tprince@reviewjournal.com. Follow [@toddprincetv](https://twitter.com/toddprincetv) on Twitter.

MORE STORIES

Preschool teachers receive active shooter training

Modern furniture and decor on display at Las Vegas Summer Market

8/9/23, 12:15 AM

More than 58K attending SHOT Show in Las Vegas | Las Vegas Review-Journal

LVCVA chief receives \$179K bonus as leaders praise 2022 results

New sports, entertainment convention coming to Las Vegas in 2024

<https://www.reviewjournal.com/business/conventions/shot-show/more-than-58k-attending-shot-show-in-las-vegas-1577754/>

7/8

Aiming high

Chris Dolnack, senior vice president and chief marketing officer of the National Shooting Sports Foundation, expects SHOT Show visitation to surge to 80,000 over the next two years as it expands into the MGM Grand Conference Center in 2020 and Caesars Convention Center in 2021.

The SHOT Show is banging up against capacity restraints at Sands, limiting the number of exhibitors and attendees, Dolnack said. The SHOT Show has been held at Sands for many years, with attendance hovering between 60,000 and 68,000.

The Supplier Showcase — a two-day event for manufacturers, engineers, purchasing agents and research specialists — will move from the Sands to the MGM Grand next year and expand to four days, Dolnack said.

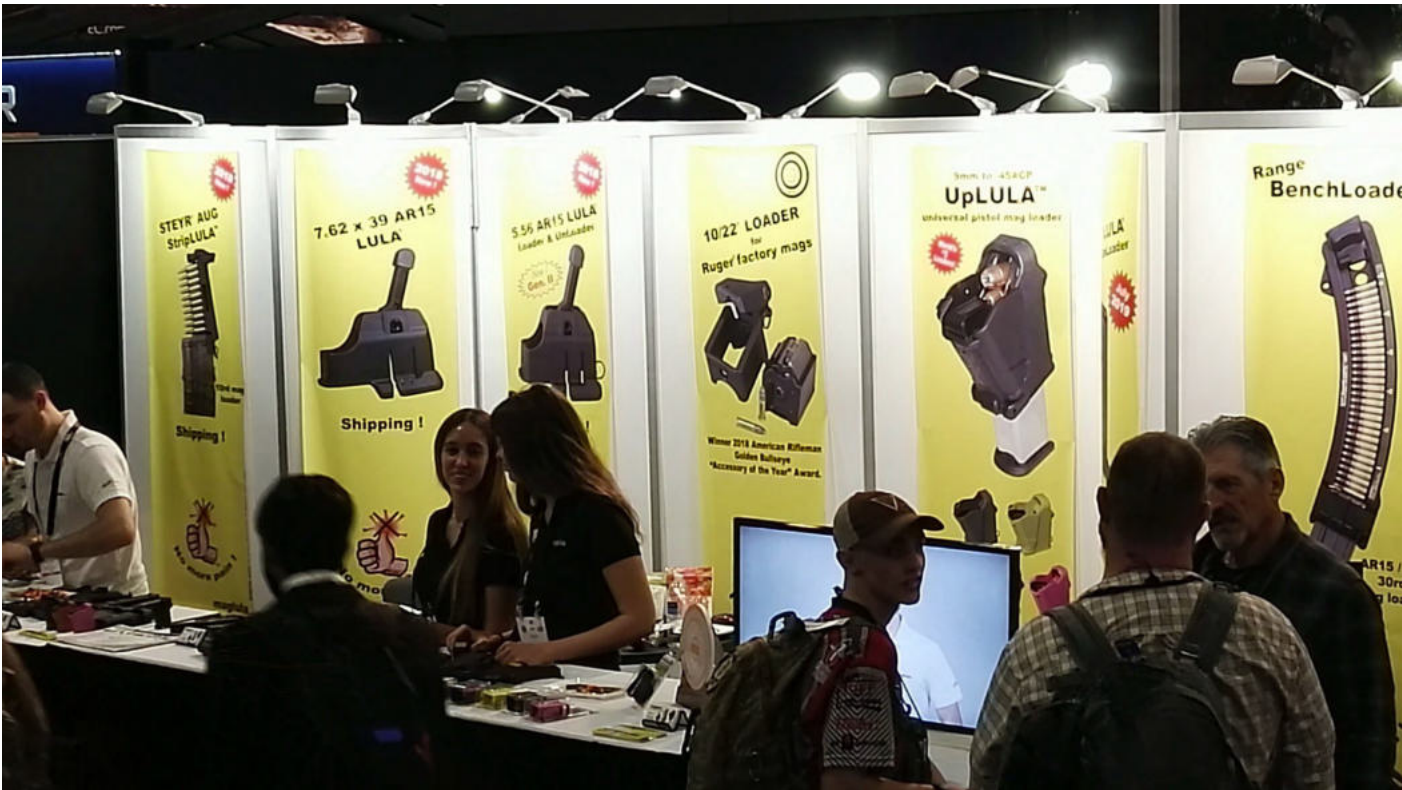

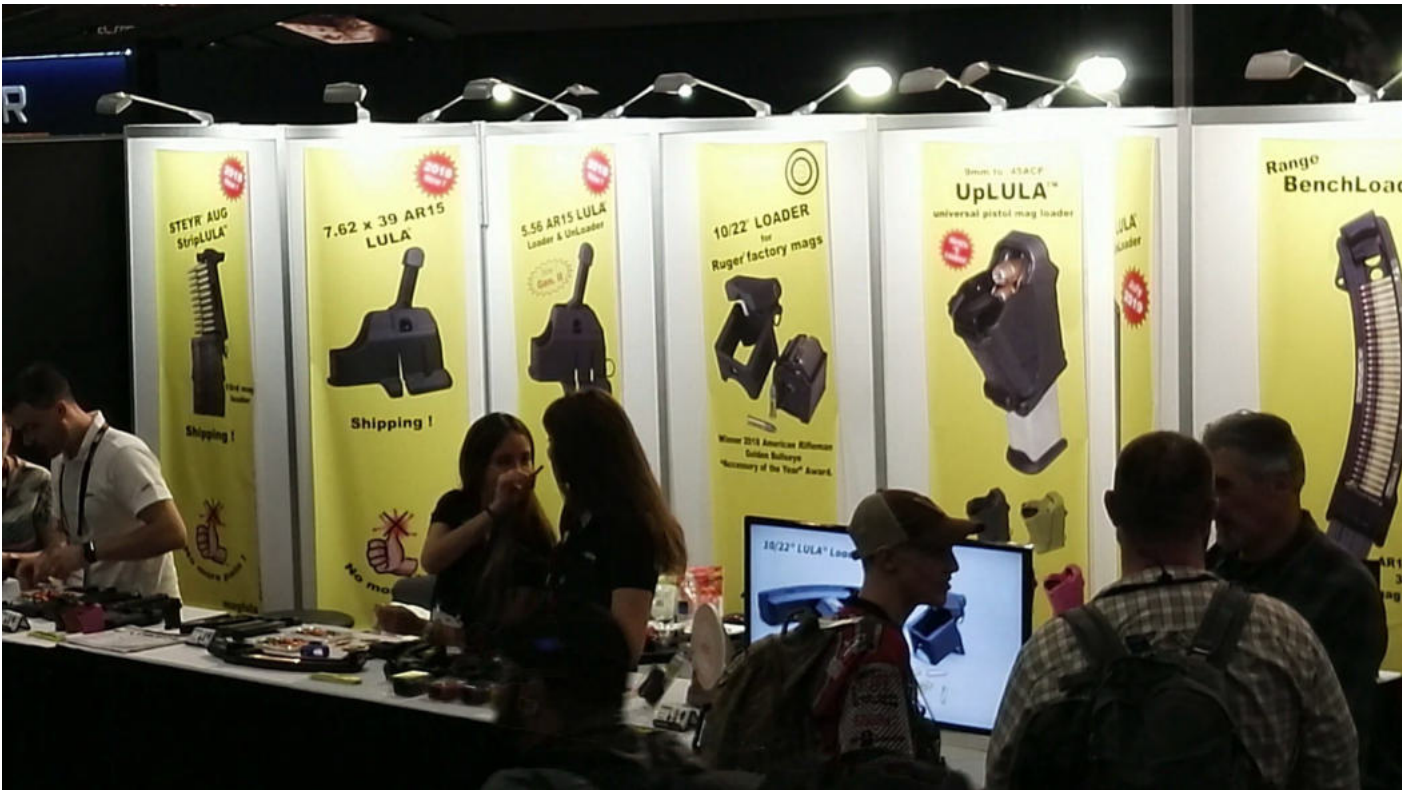







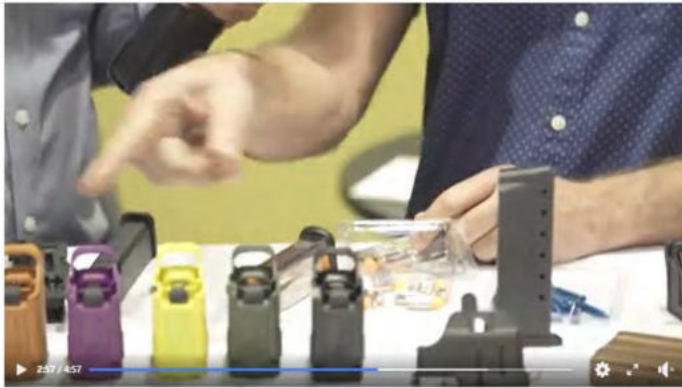

New shooting sports gear LIVE from NASGW

Like Comment Share

10 · 1.3K views

GunStuff TV was live.
October 23, 2019 ·
Interviews with shooting sports industry professionals talking about new gear for 2020. Host Christ...
See more

<https://www.facebook.com/gunstuff/videos/434999640492566> 09.09.2023



New shooting sports gear LIVE from NASGW

Like Comment Share

10 · 1.3K views

GunStuff TV was live.
October 23, 2019 · [Follow](#)

Interviews with shooting sports industry professionals talking about new gear for 2020. Host Christ...
[See more](#)



Help their budget go farther
Shop gift cards

Back to results



Roll over image to zoom in



Solid Designs Magazine Loader for Smith & Wesson M&P Shield Plus 9mm

Brand: Solid Designs
4.4 ★★★★★ 455 ratings
200+ bought in past month

\$11.95

FREE Returns

Get \$50 off instantly: Pay \$0.00 ~~from \$11.95~~ upon approval for Amazon Visa. No annual fee.

- Designed for the Smith & Wesson Shield Plus 9mm Magazine
- ***Please Note: Does NOT work with any other Shield model ***
- Large side flanges and collar make for easy loading
- 3D Printed in the USA and very durable
- Allows one hand to hold magazine and other to load bullets or simply rested on table and pushed down.

Delivery

Pickup

\$11.95

FREE Returns

FREE delivery Friday, September 15. Details

Choose location for most accurate options

In Stock

Qty: 1

Add to Cart

Buy Now

Payment	Secure transaction
Ships from	EZMAGLOADER
Sold by	EZMAGLOADER
Returns	Eligible for Return, Refund or Replacement within 30 days of receipt

Add to List

https://www.amazon.com/Magazine-Loader-Smith-Wesson-Shield/dp/B094RDP6FK/ref=zg_bs_g_3226340011_sccl_24/145-4374925-8001319?psc=1 09.10.2023

Help their budget go farther Shop gift cards

Back to results



Roll over image to zoom in



ETS Speed Loader Universal Pistol Handgun Magazine Reloader

Visit the ETS Store
4.0 ★★★★★ 11,208 ratings
2K+ bought in past month

-27% \$22.00
List Price: \$29.95

Get Fast, Free Shipping with Amazon Prime
FREE Returns

Get \$50 off instantly: Pay \$0.00 ~~\$22.00~~ upon approval for Amazon Visa. No annual fee.

Available at a lower price from other sellers that may not offer free Prime shipping.

Color: 9MM / .40SW



Color	9MM / .40SW
Brand	ETS
Material	Composite
Item	13.5 x 1.5 x 6.25 inches
Dimensions	LxWxH
Item Weight	0.19 Pounds

About this item

Additional Details

Small Business
This product is from a small business brand. Support small. [Learn more](#)

prime
Enjoy fast, FREE delivery, exclusive deals and award-winning movies & TV shows with Prime
Try Prime and start saving today with Fast, FREE Delivery

Delivery Pickup

\$22.00
Get Fast, Free Shipping with Amazon Prime
FREE Returns
FREE delivery Saturday, September 16 on orders shipped by Amazon over \$35
Or fastest delivery Tuesday, September 12. Order within 8 hrs 1 min

Choose location for most accurate options

In Stock

Qty: 1

Add to Cart
Buy Now

Payment Secure transaction
Ships from Amazon
Sold by ETS Group
Returns Eligible for Return, Refund or Replacement within 30 days of receipt

Add a gift receipt for easy returns

Add to List

https://www.amazon.com/ETS-Universal-Handgun-Magazine-Reloader/dp/B074Q22SQG/ref=zg_bs_g_3226340011_sccl_2/145-4374925-8001319?th=1 09.10.2023

Help their budget go farther
Shop gift cards

Back to results



Roll over image to zoom in



Caldwell Universal Pistol Loader with Ergonomic Design, Solid Fit Magazine Setting and Multi-Caliber Operation for Outdoor, Range, Shooting and Competition

Visit the Caldwell Store

4.3 2,026 ratings

400+ bought in past month

Lowest price in 30 days

-30% \$10.66

Typical price: \$15.22

Get Fast, Free Shipping with Amazon Prime
FREE Returns

Get \$50 off instantly: Pay \$0.00 ~~\$40.66~~ upon approval for Amazon Visa. No annual fee.

Color	black
Brand	Caldwell
Material	Plastic
Item Dimensions LxWxH	9.3 x 6.7 x 2 inches
Item Weight	0.5 Pounds

About this item

Frequently bought together



This item: Caldwell Universal Pistol Loader with Ergonomic Design, Solid Fit Magazine...

ETS Speed Loader Universal Pistol Handgun Magazine Reloader

MakerShot Magazine Speed Loaders, Designed Specifically for Each Selected Magazine

Total price: \$49.65

Add all three to Cart

These items are shipped from and sold by different sellers. Show details

prime

Enjoy fast, FREE delivery, exclusive deals and award-winning movies & TV shows with Prime
Try Prime and start saving today with Fast, FREE Delivery

Delivery Pickup

\$10.66

Get Fast, Free Shipping with Amazon Prime
FREE Returns

FREE delivery Saturday, September 16 on orders shipped by Amazon over \$35

Or fastest delivery Tuesday, September 12. Order within 8 hrs 9 mins

Choose location for most accurate options

In Stock

Qty: 1

Add to Cart Buy Now

Payment Secure transaction
Ships from Amazon.com
Sold by Amazon.com
Returns Eligible for Return, Refund or Replacement within 30 days of receipt

Add a gift receipt for easy returns

Add to List

https://www.amazon.com/Caldwell-110002-Universal-Pistol-Magazine/dp/B01MS120UH/ref=zg_bs_g_3226340011_sccl_7/145-4374925-8001319?psc=1 09.10.2023

Help their budget go farther
Shop gift cards

Back to results



SIMPLE TO USE & FAST LOADING

Just feed and press in only 2 steps to load.

1 FASTEST
BULLET/SECOND



Roll over image to zoom in

Ludex Universal Pistol Speed Loader, Mag Reloader for 9mm Luger 10mm .40S&W .45ACP .357Sig .380ACP 1911 Single and Double Stack Magazines

Visit the Ludex Store

4.3 1,203 ratings

200+ bought in past month

\$19.99

Get **Fast, Free Shipping** with Amazon Prime
FREE Returns

Get \$50 off instantly: Pay \$0.00 ~~from \$19.99~~ upon approval for Amazon Visa. No annual fee.

Color: **Black**



- **【Patent Pending】** It is the only super easy to use universal speed loader available on the market today. Just feed and press in only 2 steps to load. Fits 9mm Luger, 10mm, .40S&W, .45ACP, .357SIG, .380ACP and 1911 magazines, including single and double-stack magazines. Our speed loader is an independently-developed design. US patent applied for.
- **【Fast Loading】** Faster and easier to load. Up to one round per second, almost three times faster than loading by hand. Saves you a lot of time and spent more time for shooting.
- **【No Pain】** No fingers pushing or pressing design, eliminate thumb or wrist pain and injury, load thousands of rounds painlessly.
- **【Pocket Size】** Lightweight and pocket design, makes it easy to pack into your bag or keep in your pocket. Only 3.90*1.69*2.64inch.
- **【High Quality】** Made of superior nylon material, eliminates wear on feed lips and prolongs magazine life. Does not affect bullet loading for long-term use. If there is any problem, we offer free return.

prime
Enjoy fast, **FREE** delivery, exclusive deals and award-winning movies & TV shows with Prime
Try Prime and start saving today with **Fast, FREE Delivery**

Delivery Pickup

\$19.99

Get **Fast, Free Shipping** with Amazon Prime
FREE Returns

FREE delivery **Saturday, September 16** on orders shipped by Amazon over \$35

Or fastest delivery **Tuesday, September 12**. Order within 8 hrs 11 mins

Choose location for most accurate options

In Stock

Qty: 1

Add to Cart
Buy Now

Payment: Secure transaction
Ships from: Amazon
Sold by: LUDEX
Returns: Eligible for Return, Refund or Replacement within 30 days of receipt

Add a gift receipt for easy returns

Add to List

Have one to sell?
Sell on Amazon

https://www.amazon.com/Ludex-Universal-Magazine-Magazines-Black/dp/B09Y97HKPG/ref=zg_bs_g_3226340011_sccl_14/145-4374925-8001319?th=1 09.10.2023

Help their budget go farther Shop gift cards

Back to results



Roll over image to zoom in

The BEML Fastest and Easiest Way to Load a Magazine Fits All Calibers, Ease - Magazine Loader

Visit the Captain Jax Store
4.1 ★★★★★ 767 ratings
100+ bought in past month

\$12.99

Get Fast, Free Shipping with Amazon Prime

Get \$50 off instantly: Pay \$0.00 ~~from \$12.99~~ upon approval for Amazon Visa. No annual fee.

Size: 1 Loader

1 Loader	2 Loaders	4 Loaders
\$12.99	\$19.99	\$34.99

- Color: black
- Brand: Captain Jax
- Material: Alloy Steel
- Number Of Pockets: 1
- Pocket: Slip Pocket

About this item

prime
Enjoy fast, FREE delivery, exclusive deals and award-winning movies & TV shows with Prime
Try Prime and start saving today with Fast, FREE Delivery

Delivery Pickup

\$12.99

Get Fast, Free Shipping with Amazon Prime

FREE delivery Saturday, September 16 on orders shipped by Amazon over \$35

Or fastest delivery Tuesday, September 12. Order within 8 hrs 15 mins

Choose location for most accurate options

In Stock

Qty: 1

Add to Cart Buy Now

Payment: Secure transaction
Ships from: Amazon
Sold by: Shop this Store
Returns: Eligible for Return, Refund or Replacement within 30 days of receipt

Add a gift receipt for easy returns

Add to List

Have one to sell? Sell on Amazon

Frequently bought together



Total price: \$51.98

Add all three to Cart

These items are shipped from and sold by different sellers. Show details

This item: The BEML Fastest and Easiest Way to Load a Magazine Fits All Calibers, Ease - Magazi...
\$12.99

MakerShot Magazine Speed Loaders, Designed Specifically for Each Selected Magazine
\$16.99

ETS Speed Loader Universal Pistol Handgun Magazine Reloader
\$22.00

https://www.amazon.com/BEML-Fastest-Easiest-Magazine-Caliber/dp/B08L9QDWP9/ref=zg_bs_g_3226340011_sccl_22/145-4374925-8001319?th=1&psc=1 09.10.2023

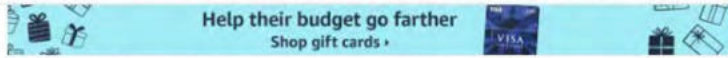

Sports & Outdoors > Hunting & Fishing > Shooting > Gun Accessories, Maintenance & Storage > Gun Parts & Accessories > Magazine Loaders



Roll over image to zoom in



SPEED BEEZ® Magazine Loader for 9mm PCC Glock® Mags 17,18,19

Brand: Speed Beez
4.7 ★★★★★ 1,002 ratings
100+ bought in past month

\$29.95

Get Fast, Free Shipping with Amazon Prime
FREE Returns

Get \$50 off instantly: Pay \$0.00 ~~\$29.95~~ upon approval for Amazon Visa. No annual fee.

Color	Black
Brand	Speed Beez
Number Of Pockets	1
Pocket Description	Slip Pocket

About this item

Additional Details

Small Business
This product is from a small business brand. Support small. [Learn more](#)



Enjoy fast, FREE delivery, exclusive deals and award-winning movies & TV shows with Prime
Try Prime and start saving today with Fast, FREE Delivery

Delivery Pickup

\$29.95

Get Fast, Free Shipping with Amazon Prime
FREE Returns

FREE delivery **Saturday, September 16** on orders shipped by Amazon over \$35

Or fastest delivery **Tuesday, September 12**. Order within 8 hrs 16 mins

Choose location for most accurate options

In Stock

Qty: 1

Add to Cart
Buy Now

Payment: Secure transaction
Ships from: Amazon
Sold by: Speed Beez
Returns: Eligible for Return, Refund or Replacement within 30 days of receipt

Add a gift receipt for easy returns

Add to List

Frequently bought together



Total price: \$89.85

Add all three to Cart

This item: SPEED BEEZ® Magazine Loader for 9mm PCC Glock® Mags 17,18,19
\$29.95

SPEED BEEZ® Lever Loader Sig Sauer® P365® 9mm Magazine Loader (Does NOT Work with...
\$29.95

Speed Beez® Lever Loader Glock 43X, 48 and Shield Arms S15 9mm Magazine Loader
\$29.95

https://www.amazon.com/Speed-Beez-Glock-Magazine-Loader/dp/B07D6XC5ZP/ref=cm_cr_ar_p_d_product_top?ie=UTF8 09.10.2023

Help their budget go farther Shop gift cards

Back to results



Roll over image to zoom in



MakerShot Magazine Speed Loaders, Designed Specifically for Each Selected Magazine

Visit the MakerShot Store
 4.3 41,227 ratings
#1 Best Seller in Gun Magazine Loaders
 900+ bought in past month

\$16⁹⁹

FREE Returns

Get \$50 off instantly: Pay \$0.00 ~~\$16.99~~ upon approval for Amazon Visa. No annual fee.

Available at a lower price from other sellers that may not offer free Prime shipping.

Size:
Medium

Style Name: **9 mm - Sig Sauer P365 X, XL, SAS**

9 mm - Sig Sauer P36...	.22 LR - Browning...	.22 LR - German...	.22 LR - Phoenix...
\$16.99	\$16.99	\$16.99	\$16.99
.22 LR - Ruger...	.22 LR - Ruger LCP II	.22 LR - Ruger Mar...	.22 LR - Ruger SR22
\$16.99	\$16.99	\$16.99	\$16.99
.22 LR - S&W 22A22 LR - S&W...	.22 LR - S&W...	.22 LR - S&W Mod...
\$16.99	\$16.99	\$16.99	\$16.99
.22 LR - S&W SW2...	.22 LR - Sig Sauer...	.22 LR - Taurus PT...	
\$16.99	\$16.99	\$16.99	

See all 208 options

- ✓ **CUSTOM RELOADER:** This is NOT a universal loader. We offer over 200 different magazine compatibilities. Please verify CALIBER and MAGAZINE compatibility in the dropdown menu. Each speed loader is designed to provide marksmen with the best comfort and utility for their guns.
- ✓ **PROTECT YOUR FINGERS:** MakerShot speed loaders allow you to drop rounds into each magazine without having to manually press each round with your thumbs. Easy load assist will prevent sore fingers at the range. Great speed, ergonomics, and durability decreases load time so you can get back to firing.
- ✓ **HANDLES SMOOTHLY:** Perfectly fits onto each selected magazine for ideal loading of every round. Made of high-quality polymer for fast and easy reloading that will last a lifetime. Compact design fits in your pocket to carry anywhere.
- ✓ **QUICK & EASY LOADING:** Solid, compact design has no springs for increased durability and efficiency. The 360 degree rim allows for one handed or table assisted reloading. Quickly and easily attaches to each magazine for fast and painless loading.
- ✓ **BEST GUN PARTS & ACCESSORIES:** MakerShot magazine speedloaders are American made with a high-quality polymer. Our products are simple, useful, and tested for shooters and survivalists looking for economical solutions at the range and beyond.

Additional Details

Small Business
 This product is from a small business brand. Support small. [Learn more](#)

Delivery Pickup

\$16⁹⁹

FREE Returns

FREE delivery **Friday, September 15.** Details

Choose location for most accurate options

In Stock

Qty: 1

Add to Cart

Buy Now

Payment Secure transaction
 Ships from MakerShot
 Sold by MakerShot
 Returns Eligible for Return, Refund or Replacement within 30 days of receipt

Add to List

New & Used (3) from \$15⁷³ FREE Shipping on orders over \$35.00 shipped by Amazon.

Other Sellers on Amazon
\$16.99 Add to Cart
 FREE Shipping on orders over \$35.00 shipped by Amazon.
 Sold by: MakerShot

Have one to sell?
 Sell on Amazon

https://www.amazon.com/MakerShot-Custom-Caliber-Magazine-Speedloader/dp/B07CYXPS5K/ref=zg_bs_g_3226340011_scl_1/145-4374925-8001319?th=1&psc=1 09.10.2023

Help their budget go farther Shop gift cards

Back to results



Roll over image to zoom in

Ludex Magazine Speed Loader for Glock 9mm/.40. Fits Glock 17, 18, 19, 22, 23, 24, 26, 27, 34, 35, 45 and 47
 Visit the Ludex Store
 4.6 ★★★★★ 2,122 ratings
 800+ bought in past month

\$19.99

Get Fast, Free Shipping with Amazon Prime
 FREE Returns

Get \$50 off instantly: Pay \$0.00 ~~\$19.99~~ upon approval for Amazon Visa. No annual fee.

Color: Black



- **【Unique Design】** Only 2 steps to complete the loading when you insert the magazine into the loader. Made of superior polymer materials, sturdy and durable. It has good heat, scratch resistance.
- **【Easy Loading】** Very fast loading, easy to use, just push and feed. Loads every round flawlessly and effortlessly! Makes loading these difficult-to-load magazine super easy!
- **【No Pain】** Saves your thumbs and loads a whole mag with ease. No tired or sore fingers loading magazine.
- **【Suitable Model】** Fits Glock 17, 18, 19, 22, 23, 24, 26, 27, 34, 35, 45, 47. Work only with above model with 9mm and .40sw. Also fits magazines of other brands compatible with the above models.
- **What You Get-** Glock 9mm speed loader, manual. Ludex offer worry-free 1 year warranty, and friendly customer service, if you have any problem with Ludex speed loader, please feel free to contact us.

There is a newer model of this item:

Ludex Universal Pistol Speed Loader, Mag Reloader for 9mm Luger 10mm .40S&W .45ACP .357Sig .380ACP 1911 Single and Double Stack Magazines
 \$19.99
 ★★★★★ (1,203)
 In Stock

prime
 Enjoy fast, FREE delivery, exclusive deals and award-winning movies & TV shows with Prime
 Try Prime and start saving today with Fast, FREE Delivery

Delivery Pickup

\$19.99
 Get Fast, Free Shipping with Amazon Prime
 FREE Returns

FREE delivery Saturday, September 16 on orders shipped by Amazon over \$35

Or fastest delivery Tuesday, September 12. Order within 7 hrs 54 mins.

Choose location for most accurate options

In Stock

Qty: 1

Add to Cart

Buy Now

Payment Secure transaction
 Ships from Amazon
 Sold by Novick
 Returns Eligible for Return, Refund or Replacement within 30 days of receipt

Add a gift receipt for easy returns

Add to List

Have one to sell?





Sell on Amazon

https://www.amazon.com/Ludex-Magazine-Glock-9mm-40sw-Fits/dp/B09GM7KFJT/ref=zg_bs_g_3226340011_sccl_3/145-4374925-8001319?th=1 09.10.2023



UpLula Pistol Mag Loader & Unloader 9mm to 45ACP / Magazine Speed Loader Review

 **yarovy**
797 subscribers **Subscribe**

 4.7K   Share  Save 

770K views 9 years ago
This is a quick review on a speed loader i found online. This is probably the best speed loader i've had so far. Build quality is amazing, and it works flawlessly. I only paid \$37.24
...more

<https://www.youtube.com/watch?v=MI1UqGPAf8M> 09.10.2023



Maglula Magazine Loader Simply Amazing!



hickok45 ✓
7.37M subscribers

Subscribe

👍 9K



➦ Share

⋮ Save



705K views 11 years ago

I never used these things until recently. It's obvious why so many people want to know what type it is; the things just works!

----- Hickok45 videos are filmed on my own private shooting range and property by trained ...more

<https://www.youtube.com/watch?v=kOaqyvd3LS0> 09.10.2023



UpLULA Universal Pistol Magazine Loader



BigDaddyHoffman1911
312K subscribers

Subscribe

👍 1.3K 💬 ➦ Share ⚙️ Save ⋮

351K views 12 years ago

Sweet UpLULA Universal Pistol Magazine Loader Pie! Hope you enjoy the video. Hope you enjoyed the video and as always Thanks For Watching. If you like this video Please Like, Favorite, Share and Subscribe. More info below, check it out. ...more

<https://www.youtube.com/watch?v=tw38hGVNct8> 09.10.2023

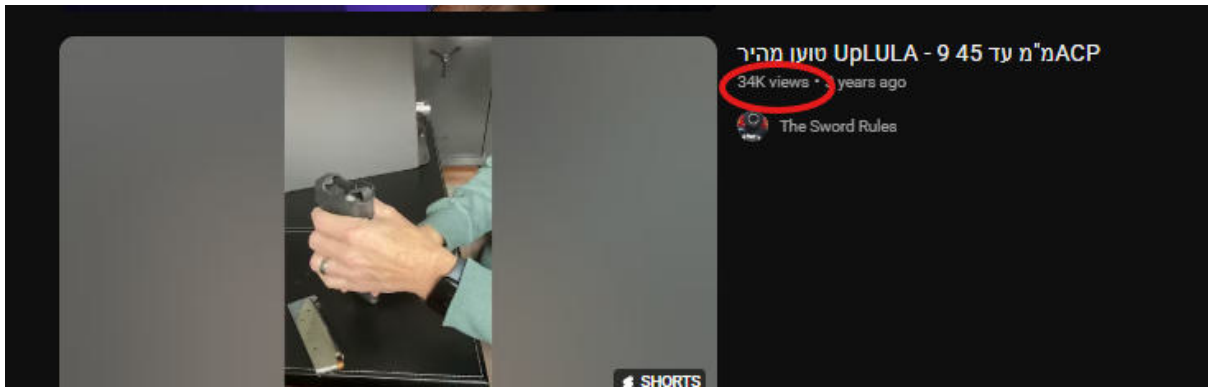

סקירה שאינה מוזמנת:

<https://www.youtube.com/shorts/oHuy---AONk>

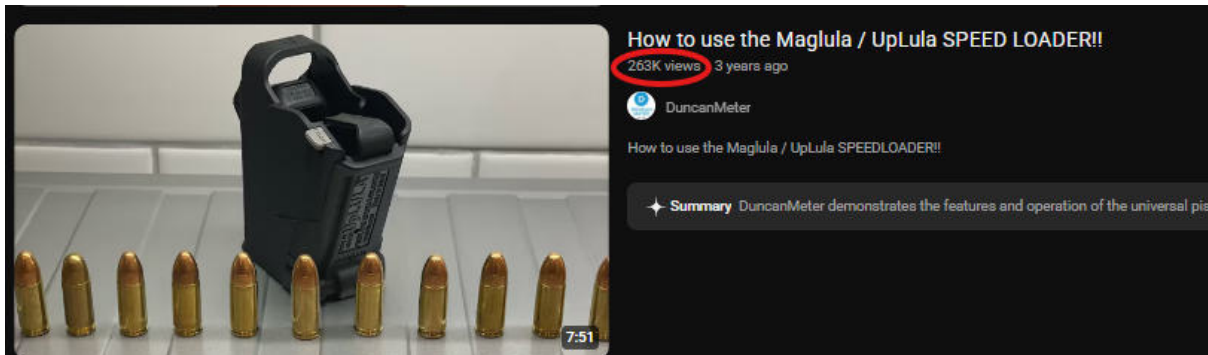

סקירה שאינה מוזמנת:

<https://www.youtube.com/watch?v=Bri4tkzZh8g>

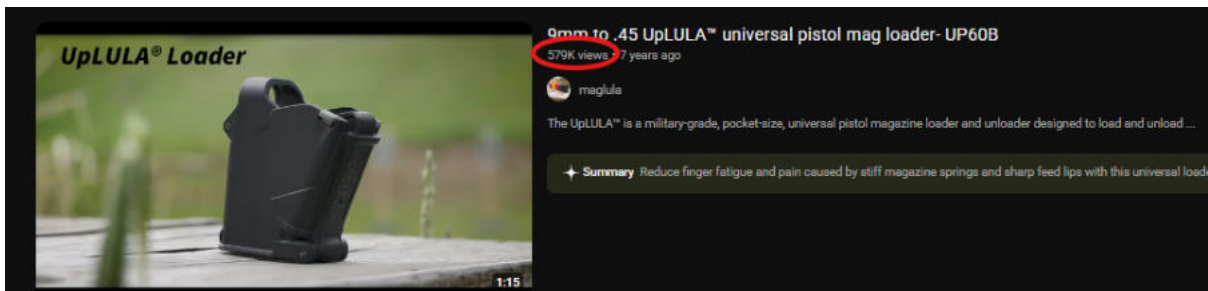

עמוד היוטיוב של המבקשת:

<https://www.youtube.com/watch?v=fTk2otnovzs&pp=ygUM157Xktec15XXnNeU>

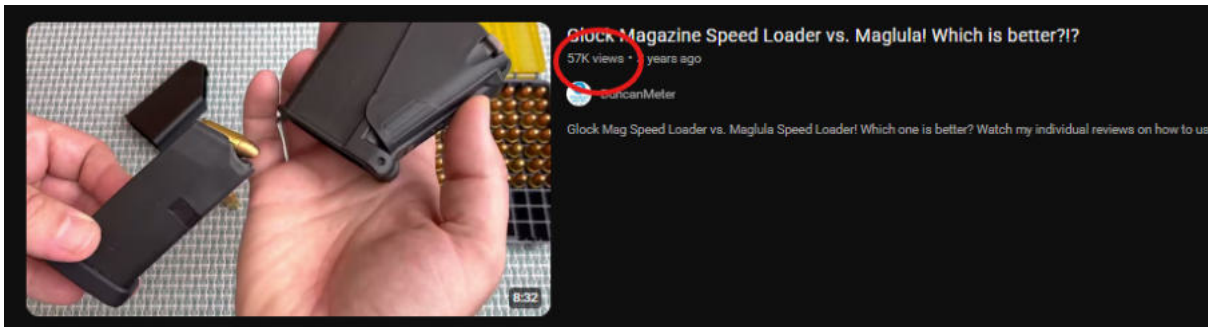

סקירה שאינה מוזמנת:

https://www.youtube.com/watch?v=hyNw_eSG410&pp=ygUM157Xktec15XXnNeU



סקירה שאינה מומזנת:

<https://www.youtube.com/shorts/FaXwFgd19Sw>

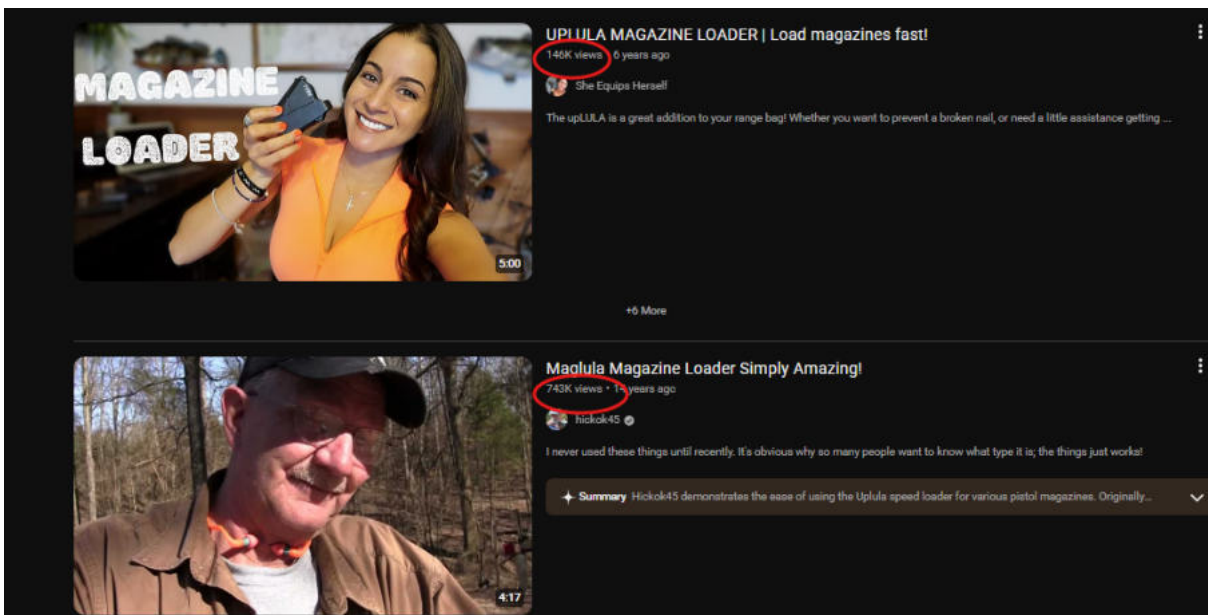

סקירות שאינן מוזמנות:

<https://www.youtube.com/watch?v=CVVEQ7bAEFs&pp=ygUM157Xktec15XXnNeU>

<https://www.youtube.com/watch?v=kOaqyvd3LS0&pp=ygUM157Xktec15XXnNeU>